

December 29, 2023

ATLAS OF FINITE-DIMENSIONAL ALGEBRAS

JAN SCHRÖER

CONTENTS

Introduction	8
Content	8
Disclaimer and call for help	8
Publication	8
Acknowledgements	8
Notation and conventions	8
Part 1. Classes of finite-dimensional algebras	10
Overview	10
Classes	10
Metaclasses	12
What's new?	20
Future additions to the FD-Atlas	20
1. Representation-finite algebras	21
1.1. Representation-finite algebras	21
1.2. Standard algebras	28
1.3. Directed algebras	29
1.4. Distributive algebras	33
2. Tame and wild algebras	36
2.1. Tame algebras	36
2.2. Wild algebras	41

3. Hereditary algebras	45
3.1. Semisimple algebras	45
3.2. Hereditary algebras	48
3.3. Species	61
3.4. Preprojective algebras	65
3.5. Quasi-hereditary algebras	68
3.6. Schur algebras	76
4. Tilted algebras	79
4.1. Tilting theory	80
4.2. τ -tilting theory	85
4.3. Concealed algebras	89
4.4. Canonical algebras	91
4.5. Quasi-tilted algebras	98
4.6. Shod algebras	100
4.7. Tubular algebras	101
4.8. Auslander algebras	105
4.9. n -representation-(in)finite and n -hereditary algebras	107
4.10. τ -tilting finite algebras	111
4.11. Fractionally Calabi-Yau algebras	112
4.12. Calabi-Yau categories	115
4.13. Calabi-Yau tilted algebras	116
4.14. Jacobian algebras	120
5. Selfinjective algebras	128
5.1. Selfinjective algebras	128
5.2. Trivial extension and repetitive algebras	132
5.3. Group algebras	136
5.4. Brauer tree and Brauer graph algebras	139

5.5. Periodic algebras	143
5.6. Hopf algebras	146
6. Gorenstein algebras	148
6.1. QF-3 algebras	148
6.2. Weakly Gorenstein algebras	149
6.3. Iwanaga-Gorenstein algebras	150
6.4. n -Gorenstein algebras and Auslander-Gorenstein algebras	153
7. Biserial algebras	157
7.1. Nakayama algebras	157
7.2. Biserial algebras	159
7.3. Special biserial and string algebras	162
7.4. Gentle algebras	166
7.5. Clannish and skewed-gentle algebras	168
8. Multiplicative basis algebras	172
8.1. Multiplicative basis algebras	172
8.2. Monomial algebras	174
8.3. Incidence algebras	176
8.4. Locally hereditary algebras	186
9. Graded algebras	187
9.1. Graded algebras	187
9.2. Differential graded algebras	192
9.3. Tensor algebras	195
9.4. Enveloping algebras	196
9.5. Yoneda algebras	197
9.6. Hochschild cohomology algebras	198
9.7. Quadratic algebras	199
9.8. Koszul algebras	200

10. Other algebras	202
10.1. Local algebras	202
10.2. Minimal algebras	204
10.3. One-point extension algebras	206
10.4. Gendo-symmetric algebras	213
10.5. Triangular algebras	215
10.6. Tree algebras	217
10.7. Construction site: Simply connected algebras	219
10.8. Low-dimensional algebras	219
10.9. Construction site: Ringel-Hall algebras	221
10.10. Construction site: Cluster algebras	221
10.11. Algebras with the dense orbit property	221
10.12. Geometrically irreducible algebras	222
Part 2. Fundamental results, conjectures and techniques	224
11. Finite-dimensional algebras	224
11.1. Modules categories	224
11.2. Simple modules over finite-dimensional algebras	224
11.3. Projective and injective modules over finite-dimensional algebras	225
11.4. Homological dimensions	226
11.5. Basic algebras	230
11.6. Algebraically closed ground fields	232
11.7. Connected algebras	232
11.8. Various approaches to the representation theory of algebras	233
12. Finite length modules	233
12.1. Filtrations of modules	233
12.2. Jordan-Hölder Theorem	234
12.3. Local endomorphism rings	235

12.4. Krull-Remak-Schmidt Theorem	236
13. Homological conjectures	238
13.1. Cartan Determinant Conjecture	238
13.2. Finitistic Dimension Conjectures	239
13.3. Nakayama Conjectures	242
13.4. No Loop Conjectures	243
13.5. Global dimension conjectures	244
13.6. Conjectures on rigid modules	248
13.7. Hierarchy of homological conjectures	252
14. Auslander-Reiten theory	253
14.1. Auslander-Reiten sequences	253
14.2. Existence of Auslander-Reiten sequences	256
14.3. Translation quivers	258
14.4. Mesh category of a translations quiver	260
14.5. Valued translation quivers	261
14.6. Radical of a module category	262
14.7. Bimodules of irreducible homomorphisms	264
14.8. Auslander-Reiten quivers	265
14.9. Components of Auslander-Reiten quivers	266
14.10. Directing and reachable modules	273
14.11. Knitting algorithm	275
14.12. Examples (knitting)	281
14.13. Mesh category	288
14.14. Examples (mesh categories)	289
15. Varieties of modules and algebras	293
15.1. Varieties of modules	293
15.2. Direct sums of irreducible components	298

15.3.	g -vectors of irreducible components	300
15.4.	τ -reduced components	301
15.5.	Additive invariants for irreducible components	304
15.6.	Varieties of modules and tame algebras	305
15.7.	Richmond stratification	306
15.8.	Varieties of algebras	308
16.	Subcategories	314
16.1.	Exact subcategories and Frobenius subcategories	314
16.2.	Abelian subcategories	316
16.3.	Wide subcategories	317
16.4.	Serre subcategories	319
16.5.	Thick subcategories	319
16.6.	Resolving and coresolving subcategories	320
16.7.	Co- and contravariantly finite subcategories	320
16.8.	Torsion pairs	322
16.9.	Hierarchy of subcategories	325
16.10.	Functorially finite torsion classes	325
16.11.	Chains of torsion classes and stability	328
Appendix A.	Categories	336
A.1.	Coproducts	336
A.2.	Products	336
A.3.	Zero objects	336
A.4.	Preadditive categories	337
A.5.	Biproducts and additive categories	337
A.6.	Ideals in additive categories	338
A.7.	Triangulated categories	338
A.8.	Kernels and cokernels in preadditive categories	340

A.9. Pushouts and pullbacks	341
A.10. Exact categories	342
A.11. Frobenius categories	345
A.12. Preabelian and abelian categories	346
A.13. Sub- and factor objects	346
A.14. Length categories	347
A.15. Idempotent complete categories	347
A.16. Krull-Remak-Schmidt categories	348
A.17. Yoneda Lemma	348
A.18. Auslander functors	349
A.19. Functor categories for module categories	351
A.20. Categories of complexes	351
A.21. Homotopy categories	353
A.22. Derived categories	354
A.23. K -categories	356
A.24. dg categories	357
Appendix B. Books and survey articles	359
Books on the representation theory of finite-dimensional algebras	359
Lecture notes and survey articles	360
Books on Homological Algebra	360
Index	361

Introduction

Content. The representation theory of finite-dimensional algebras is a relatively young area of mathematics. Its big bang or rather big bangs were Gabriel's Theorem (the classification of representation-finite quivers) in 1970, Auslander and Reiten's discovery of almost split sequences (aka Auslander Reiten sequences) in 1975, Roiter's proof of the 1st Brauer-Thrall Conjecture in 1968, and the Kiev School results on the representation theory of partially ordered sets in 1972. This also led to a conceptual proof of Gabriel's Theorem.

There is quite a large zoo of classes of finite-dimensional algebras which people study for various reasons. Many of these classes have a beautiful representation theory and often provide a link to other areas of mathematics or mathematical physics.

Part 1 is a compilation of short notes on the most important classes. (I identified about 100 of these up to now.) Usually, I will briefly define a class, give some examples, mention a few important results, and provide literature recommendations for further reading.

Part 2 contains a recollection of some fundamental results and techniques from the representation theory of finite-dimensional algebras. This includes an overview of the categories and subcategories which are frequently studied. I also give a list of general conjectures, e.g. the classical homological conjectures. Many more conjectures can be found in the various more specialized sections of Part 1.

In the appendix of the FD-Atlas there is a section containing all necessary categorical definitions and also a list of books and articles.

Disclaimer and call for help. In both parts of the FD-Atlas my selections are influenced by my personal taste and also by my ignorance and lack of knowledge. I encourage everyone to send me complaints and suggestions. I would be very happy to learn about other classes of finite-dimensional algebras and about further conjectures and open problems.

I'm aware that the citations in Part 1 are not optimal and should be improved. Please send me your suggestions. I will also try to add more examples.

Publication. The FD-Atlas will be published on my Bonn website and later also on the arXiv. I'm planning regular extensions and improvements.

Acknowledgements. I thank Gustavo Jasso for helpful discussions. I'm very grateful to Klaus Bongartz who sent me numerous suggestions and corrections.

Notation and conventions.

Throughout, let K be a (commutative) field.

By an **algebra** we mean an associative K -algebra with an identity element. Throughout, A denotes an algebra.

Our focus lies on finite-dimensional (and mostly non-commutative) algebras.

By a **module** we mean a left module, unless stated otherwise.

Our focus lies on finite-dimensional modules over finite-dimensional algebras.

$\text{mod}(A)$ is the category of finite-dimensional A -modules, and $\text{ind}(A)$ is the category of finite-dimensional indecomposable A -modules.

$\text{Mod}(A)$ is the category of all A -modules.

For a module M and $m \geq 1$ let M^m be the m -fold direct sum $M \oplus \cdots \oplus M$.

For a set X let 1_X be the identity map $X \rightarrow X$.

Given maps $f: X \rightarrow Y$ and $g: Y \rightarrow Z$, we denote their composition by

$$gf: X \rightarrow Z.$$

Sometimes we also write $g \circ f$ instead of gf .

Set $K^* = K \setminus \{0\}$.

Let $\mathbb{N} := \{0, 1, 2, 3, \dots\}$ be the natural numbers (including 0).

If I is a set, we denote its cardinality by $|I|$.

We use

blue boxes to highlight statements,

green boxes to highlight definitions,

magenta boxes to highlight conjectures and open problems,

gray boxes to highlight other contents.

Part 1. Classes of finite-dimensional algebras

Overview

Classes.

- *n*-Auslander 4.8, *n*-CY-tilted 4.13, *n*-Gorenstein 6.4, ∞ -Gorenstein 6.4, *n*-hereditary 4.9.4, *n*-Iwanaga-Gorenstein 6.3, *n*-minimal Auslander-Gorenstein 6.4, *n*-representation-finite 4.9.2, *n*-representation-infinite 4.9.3, *P*-minimal 10.2, *P*-maximal 10.2, τ -tame 2.1, τ -tilting finite 4.10
- **A** almost hereditary 4.5, Auslander 4.8, Auslander-Gorenstein 6.4, Auslander regular 6.4
- **B** biserial 7.2, Brauer graph 5.4, Brauer tree 5.4, brick finite 4.10
- **C** canonical 4.4, concealed canonical 4.4, clannish 7.5, **cluster** 10.10, cluster-tilted 4.13, concealed 4.3
- **D** dense orbit property 10.11, derived tame 2.1.5, differential graded 9.2, directed 1.3, distributive 1.4
- **E** enveloping algebra 9.4
- **F** fractionally Calabi-Yau 4.11, Frobenius 5.1.3
- **G** geometrically irreducible 10.12, gendo-symmetric 10.4, generically tame 2.1.4, gentle 7.4, Ginzburg dg 9.2, graded 9.1, group 5.3
- **H** hereditary 3.2, Hochschild cohomology 9.6, Hopf 5.6
- **I** incidence 8.3, Iwanaga-Gorenstein 6.3
- **J** Jacobian 4.14
- **K** Koszul 9.8, Koszul dual 9.8
- **L** local 10.1, locally hereditary 8.1, low-dimensional 10.8
- **M** minimal representation-infinite 4.3, monomial 8.2, multiplicative basis 8.1 (multiplicative Cartan basis, filtered multiplicative basis)
- **N** Nagase *P*-minimal 10.2, Nakayama 7.1
- **O** one-point extension 10.3
- **P** path 3.2, periodic 5.5, preprojective 3.4
- **Q** QF-3 6.1, quadratic 9.7, quasi *n*-Gorenstein 6.4, quasi ∞ -Gorenstein 6.4, quasi Auslander-Gorenstein 6.4, quasi-canonical 4.4, quasi-hereditary 3.5, quasi-tilted 4.5
- **R** repetitive 5.2.2, representation-finite 1.1 (representation-infinite), **Ringel-Hall** 10.9
- **S** Schur 3.6, selfinjective 5.1, semisimple 3.1, separable 3.1, shod 4.6, **simply connected** 10.7, skewed-gentle 7.5.2, special biserial 7.3, species 3.3, standard 1.2 (non-standard), standardly stratified 3.5, string 7.3, strongly quasi-hereditary 3.5, **strongly simply connected** ??, symmetric 5.1.5
- **T** tame 2.1 (*n*-domestic, domestic, linear growth, polynomial growth, exponential growth), tensor 9.3, tilted 4.1.5, tree 10.6, triangular 10.5, trivial extension 5.2, tubular 4.7, twisted fractionally Calabi-Yau 4.11, twisted periodic 5.5

- **W** weakly n -representation-finite [4.9.2](#), weakly Gorenstein [6.2](#), weakly shod [4.6](#), weakly symmetric [5.1.4](#), wild [2.2](#) (strictly wild, controlled wild, endo wild, controlled endo wild, WILD, strictly WILD)
- **Y** Yoneda [9.5](#)

Metaclasses. To get some structure into this, I grouped the classes of algebras into several larger metaclasses:

§1 Representation-finite	§2 Tame-wild	§3 Hereditary
§4 Tilted	§5 Selfinjective	§6 Gorenstein
§7 Biserial	§8 Multiplicative basis	§9 Graded
§10 Others		

The borders between these metaclasses are not very rigid and sometimes a bit artificial. One should not take the names of the metaclasses literally, e.g. most algebras listed in the *Tilted* metaclass are not tilted, but nevertheless they belong there morally.

The following diagrams give an overview for each metaclass. The edges indicate inclusions (the class at the lower end of an edge is contained in the class at the upper end).

§1 Representation-finite algebras:

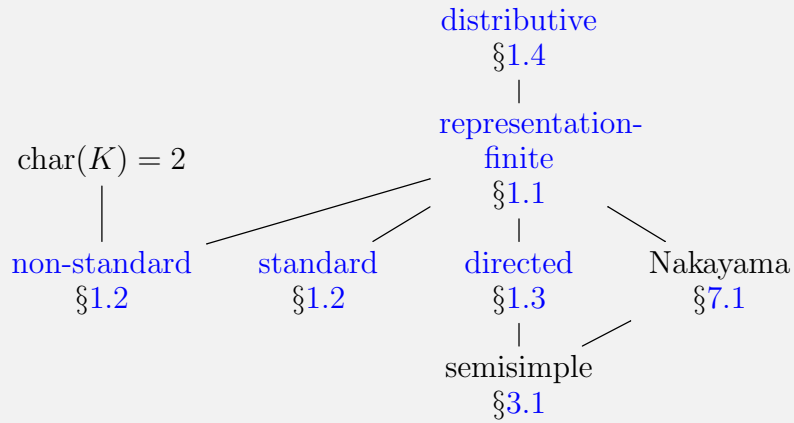

§2 Tame and wild algebras:

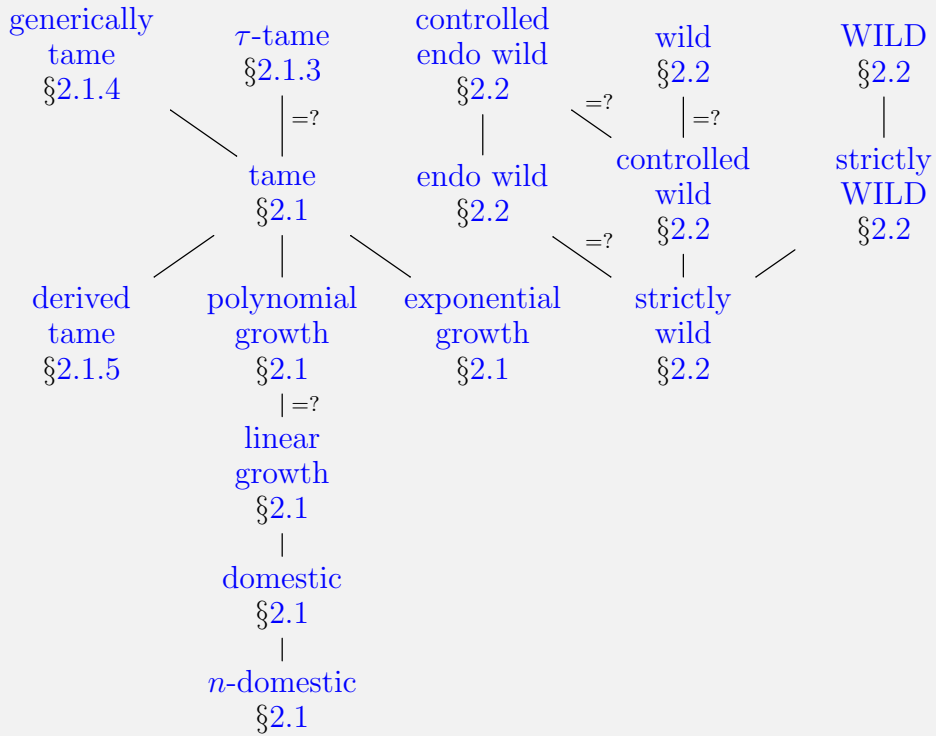

§4 Tilted algebras:

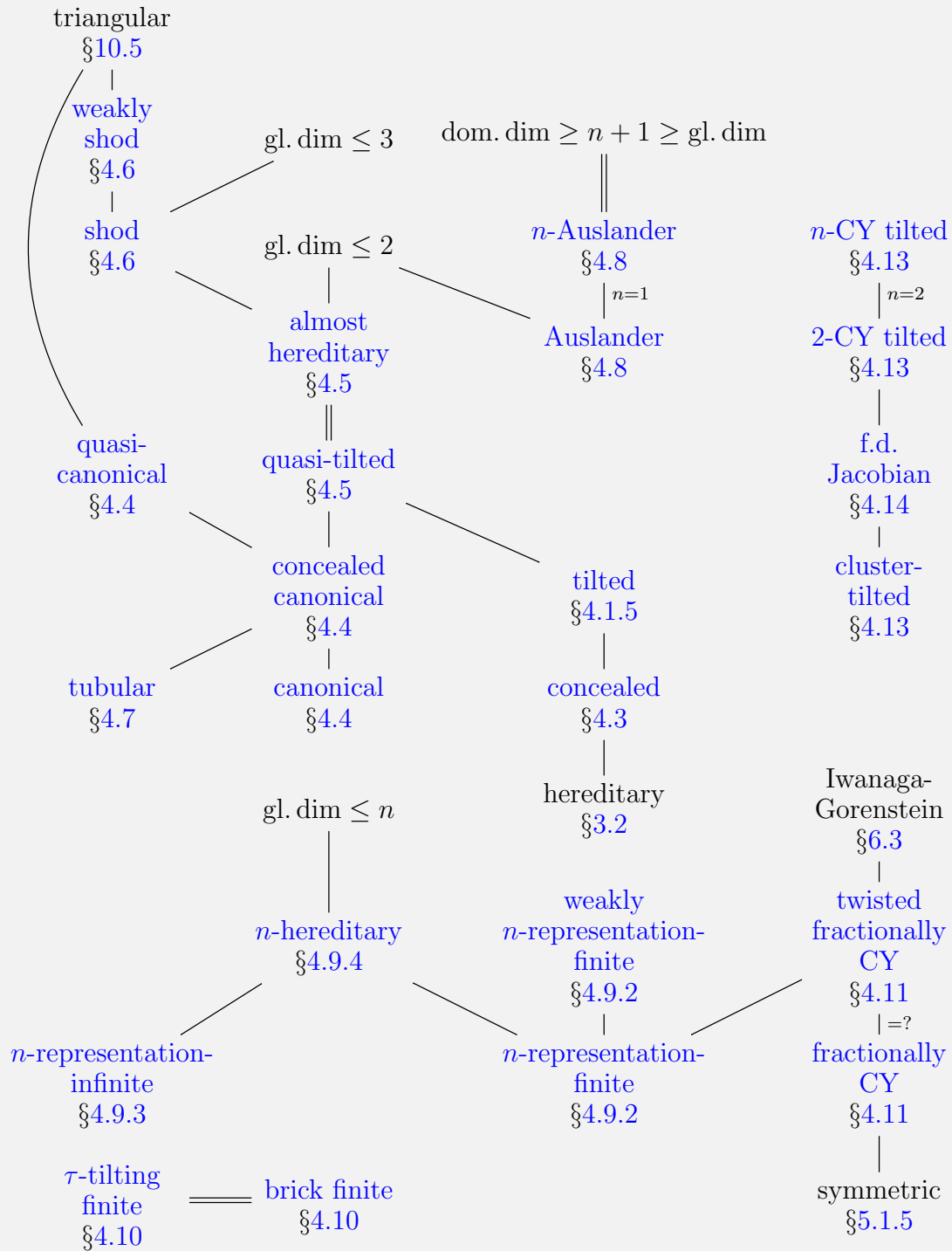

§5 Selfinjective algebras:

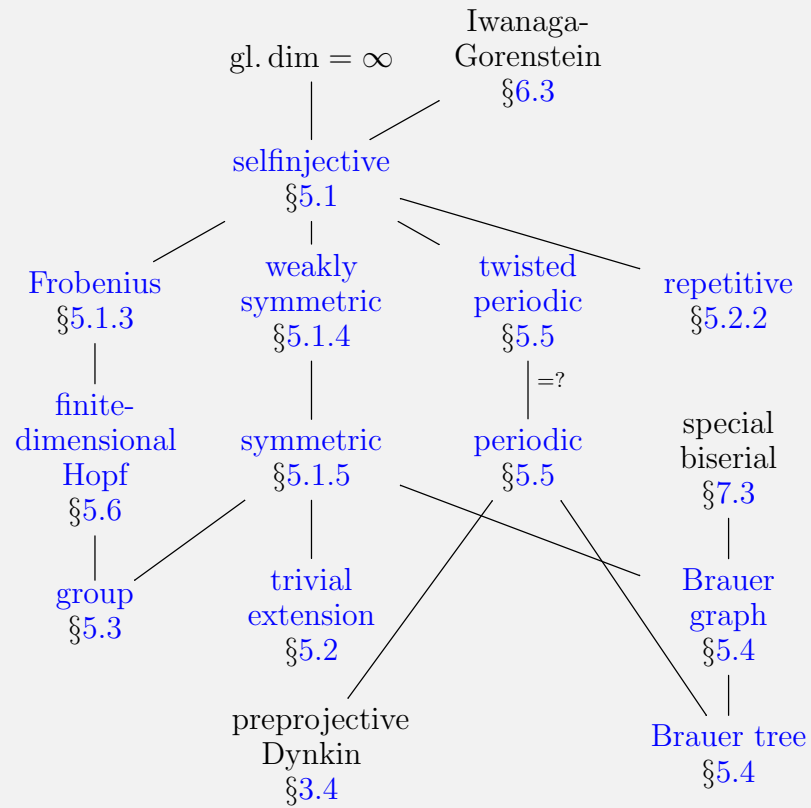

§6 Gorenstein algebras:

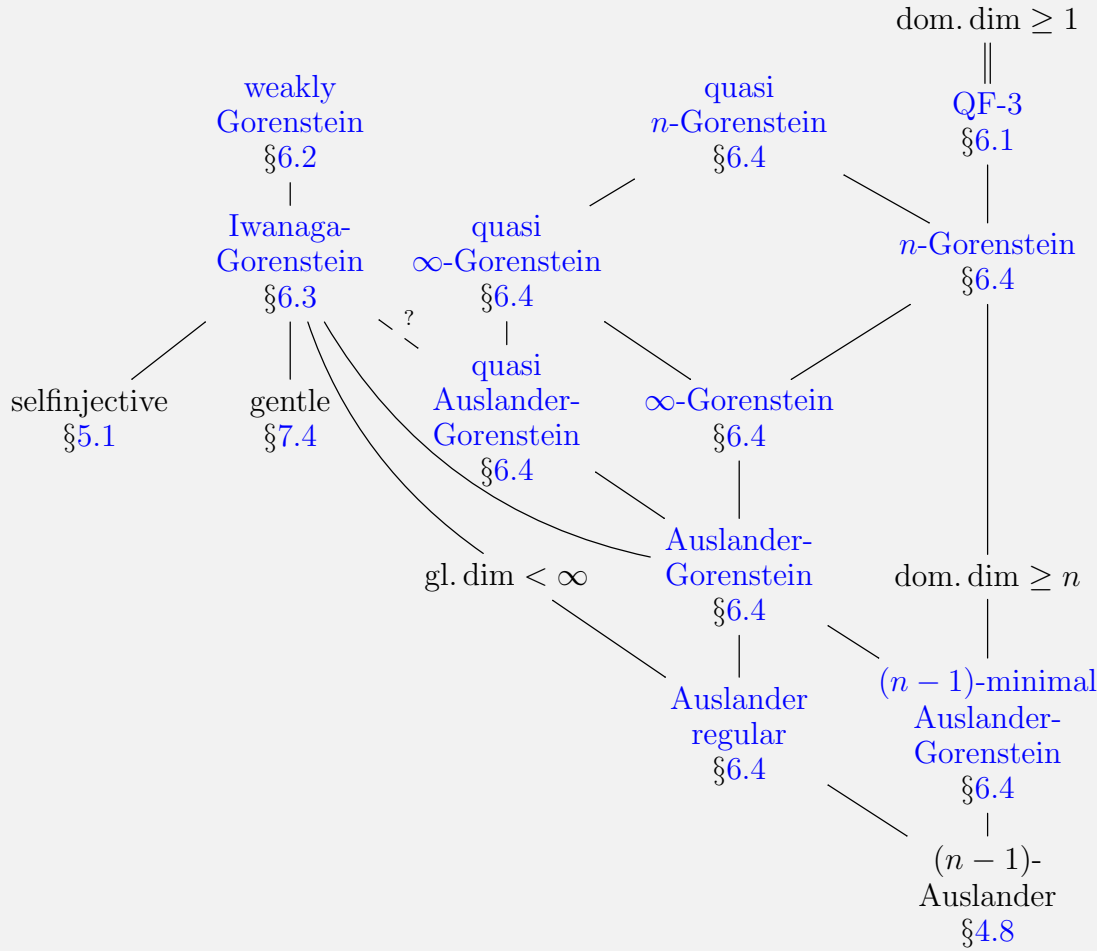

§7 Biserial algebras:

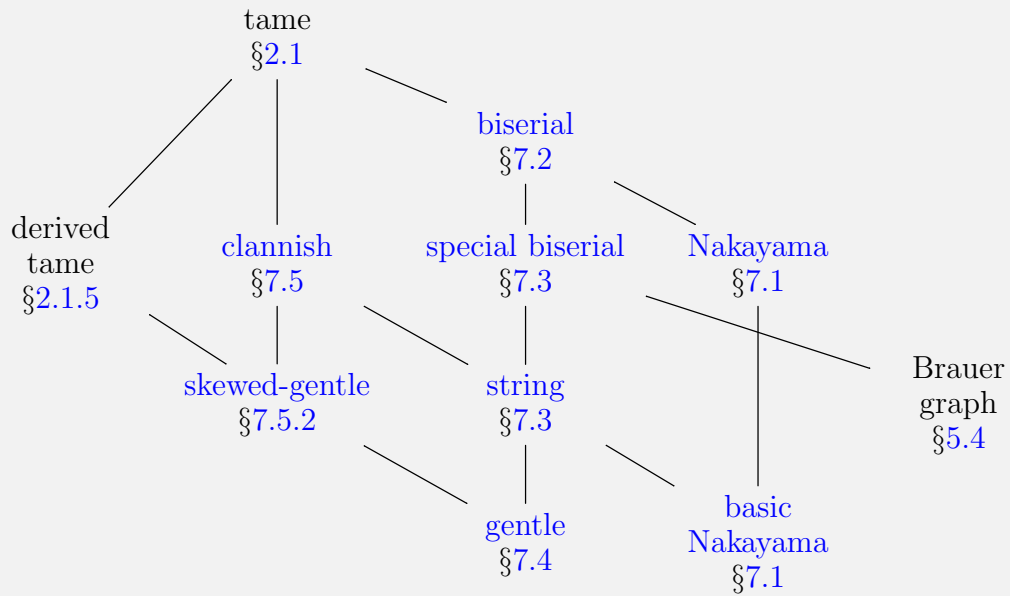

§8 Multiplicative basis algebras:

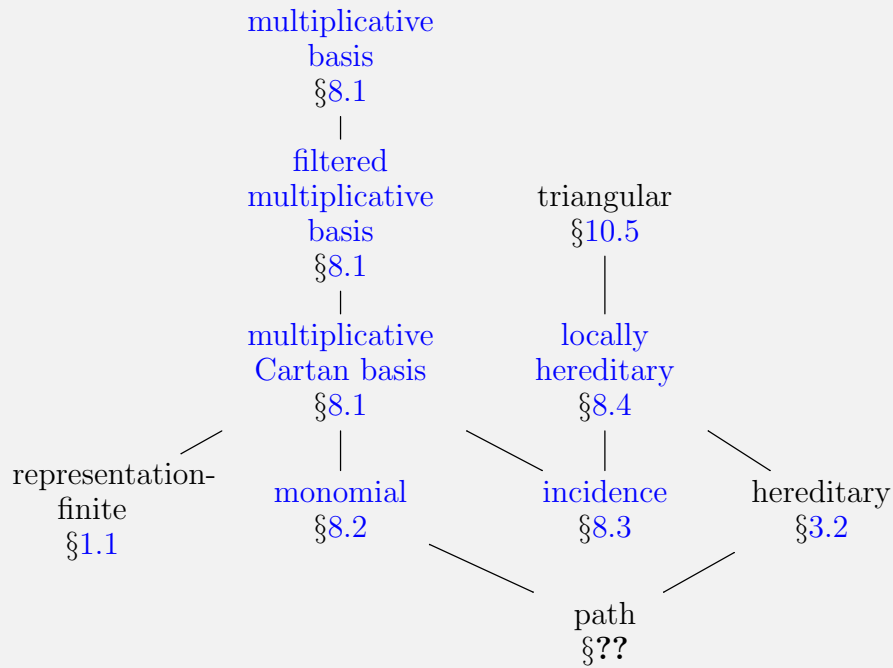

§9 Graded algebras:

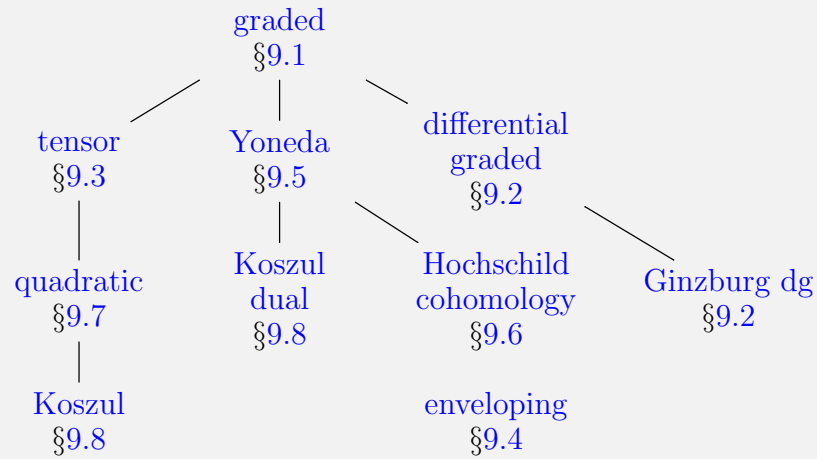

§10 Other algebras:

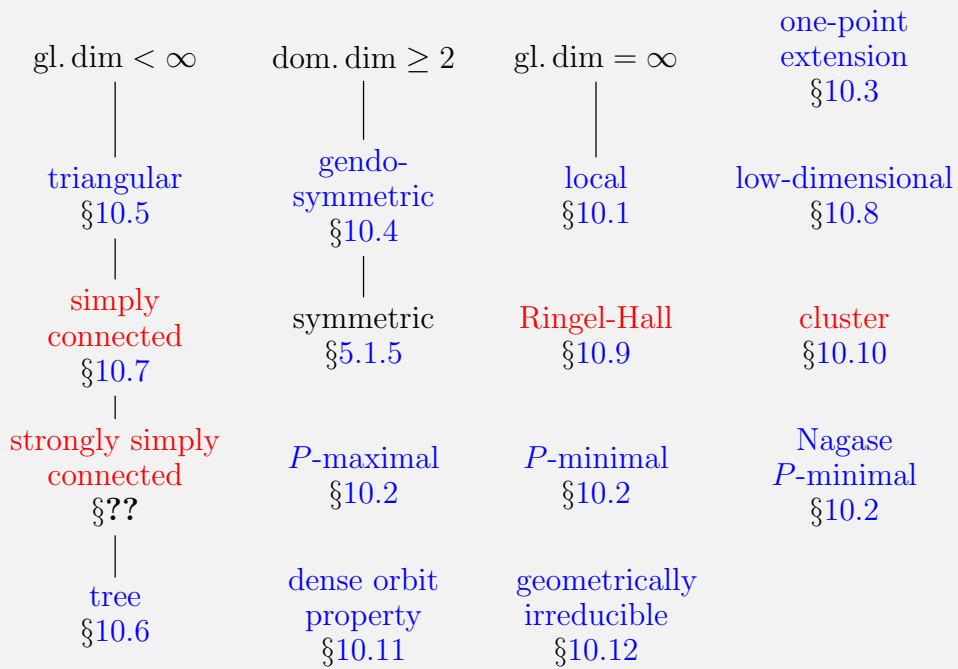

What's new?

- 25.06.22: Part 1: Expanded the section on Gorenstein algebras.
- 15.12.22: New class: geometrically irreducible algebras.
- 15.12.22: Part 2: Added a section on varieties of modules and algebras.
- 15.12.22: New class: algebras with the dense orbit property
- 15.12.22: New class: brick finite algebras.

Future additions to the FD-Atlas.

- torsionless-finite (Richmond, Ringel)
- simply connected
- strongly simply connected
- cluster
- Ringel-Hall
- piecewise hereditary (Happel's book)
- derived discrete (Vossieck)
- n -preprojective (Iyama, Oppermann)
- Serre-formal (Iyama et al)
- higher Nakayama (Jasso, Külshammer)
- multicoil
- zigzag
- surface
- hybrid (Erdmann, Skowroński)
- multiserial/special multiserial/Brauer configuration (Green, Schroll)
- pg-critical (Skowroński)
- cellular (Graham, Lehrer)
- Hecke?
- quiver Hecke?

Examples to be included:

- Liu-Schulz example (Ringel)
- Kronecker quiver (with classification)
- Klein four-group algebra (with classification)
- Beilinson algebra
- quaternion algebra
- Temperley-Lieb algebras
- Brauer algebras

Future additions to Part 2:

- Coverings of module categories
- Expand the section on varieties of modules and algebras (e.g. discuss quiver Grassmannians)
- Bocses

1. Representation-finite algebras

§1 Representation-finite algebras:

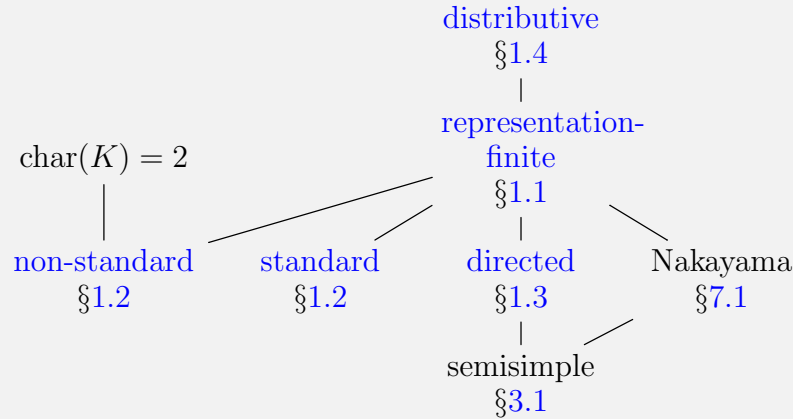

[Back to Overview Metaclasses 1.](#)

1.1. Representation-finite algebras. Let A be a finite-dimensional K -algebra.

1.1.1. Representation-finite and representation-infinite algebras.

A is **representation-finite** (or of **finite representation type**) if there are only finitely many finite-dimensional indecomposable A -modules, up to isomorphism. Otherwise, A is **representation-infinite**.

Representation-finite algebras have a beautiful representation theory. The following outline is a bit imprecise, and it is not even true in some cases, but it gives the correct broad picture:

Let K be algebraically closed, and let A be representation-finite. Then the following hold:

- (i) There is a covering $\pi: \tilde{A} \rightarrow A$ where \tilde{A} is an infinite-dimensional directed algebra.
- (ii) The knitting algorithm gives a combinatorial construction of the Auslander-Reiten quiver $\Gamma_{\tilde{A}}$.
- (iii) The pushdown functor $\pi_{\lambda}: \text{mod}(\tilde{A}) \rightarrow \text{mod}(A)$ yields the Auslander-Reiten quiver Γ_A and a covering $\Gamma_{\tilde{A}} \rightarrow \Gamma_A$.
- (iv) The mesh category of Γ_A is equivalent to $\text{mod}(A)$.

Example: Let $A = KQ/I$ where Q is the quiver

$$a \begin{array}{c} \curvearrowright \\ \leftarrow \end{array} 1 \xleftarrow{b} 2$$

and I is generated by $\{a^3, ab\}$. Let $\tilde{A} = K\tilde{Q}/\tilde{I}$ where \tilde{Q} is the infinite quiver

$$\begin{array}{ccc} \vdots & & \vdots \\ \downarrow & & \\ 1_2 & \xleftarrow{b_2} & 2_2 \\ a_1 \downarrow & & \\ 1_1 & \xleftarrow{b_1} & 2_1 \\ a_0 \downarrow & & \\ 1_0 & \xleftarrow{b_0} & 2_0 \\ a_{-1} \downarrow & & \\ 1_{-1} & \xleftarrow{b_{-1}} & 2_{-1} \\ \downarrow & & \\ \vdots & & \vdots \end{array}$$

and \tilde{I} is generated by $\{a_{i-1}a_i a_{i+1}, a_{i-1}b_i \mid i \in \mathbb{Z}\}$. (In contrast to our usual convention, the algebra \tilde{A} does not have an identity element. But it satisfies sufficiently many finiteness conditions to be treated similarly to a finite-dimensional algebra.) We get a covering

$$\pi: \tilde{A} \rightarrow A$$

defined by $1_i \mapsto 1$, $2_i \mapsto 2$, $a_i \mapsto a$ and $b_i \mapsto b$ for $i \in \mathbb{Z}$.

Clearly, \tilde{A} is \mathbb{Z} -graded. Let $A_{\mathbb{N}} = KQ_{\mathbb{N}}/I_{\mathbb{N}}$ where $Q_{\mathbb{N}}$ is the infinite quiver

$$\begin{array}{ccc} \vdots & & \vdots \\ \downarrow & & \\ 1_2 & \xleftarrow{b_2} & 2_2 \\ a_1 \downarrow & & \\ 1_1 & \xleftarrow{b_1} & 2_1 \\ a_0 \downarrow & & \\ 1_0 & \xleftarrow{b_0} & 2_0 \end{array}$$

and $I_{\mathbb{N}}$ is the ideal generated by $\{a_{i-1}a_i a_{i+1}, a_{i-1}b_i \mid i \geq 1\}$. So $A_{\mathbb{N}}$ is obtained from \tilde{A} by restricting to non-negative degrees. Now the knitting algorithm yields the Auslander-Reiten quiver $\Gamma_{A_{\mathbb{N}}}$ (the indecomposable modules are displayed by their dimension vectors, the projectives are marked in red and the injectives in blue (the first module of the 2nd and 3rd row is projective as an $A_{\mathbb{N}}$ -module but not projective

as an \tilde{A} -module):

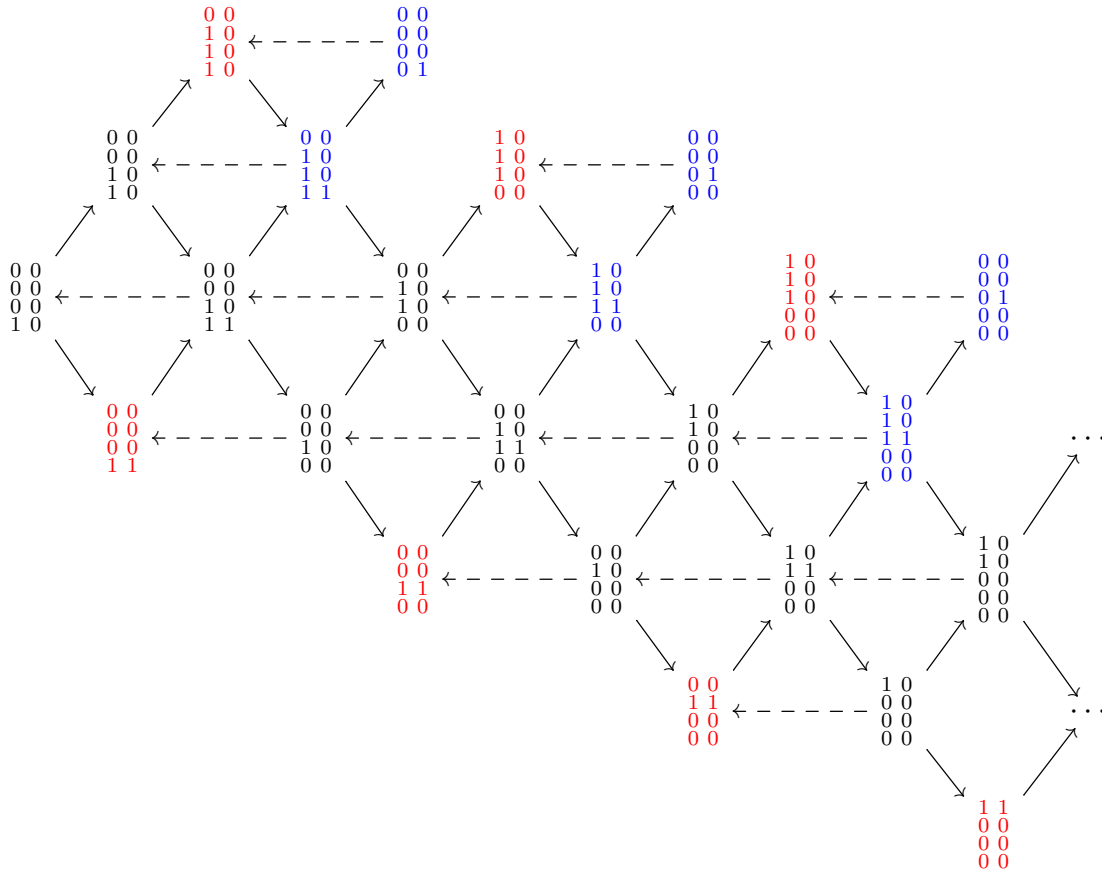

Extending this to the left gives the Auslander-Reiten quiver $\Gamma_{\tilde{A}}$.

The pushdown functor $\pi_\lambda: \text{mod}(\tilde{A}) \rightarrow \text{mod}(A)$ yields the Auslander-Reiten quiver Γ_A (the indecomposables are displayed by their composition factors):

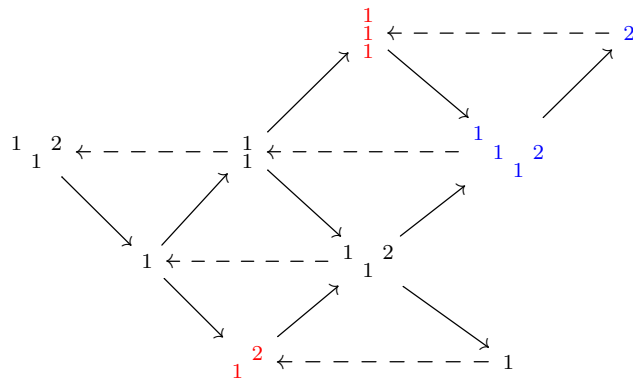

(One needs to identify the first module of the 2nd and 3rd row with the last module of the 3rd and 4th row, respectively. As before, the projectives are red and the injectives are blue.) Note that Γ_A has two τ_A -orbits.

Not many people work on representation-finite algebras right now, however there are still interesting open problems.

Bongartz [Bo13] wrote an excellent survey on the representation theory of representation-finite algebras and on the delicate issues of covering theory.

References for covering theory are [BG81] and [G81].

There is an urgent need to write text books about representation-finite algebras including a detailed and up to date introduction to covering theory.

Problem 1.1. *Develop the representation theory of representation-finite K -algebras where K is an arbitrary field.*

1.1.2. *Auslander correspondence.* For finite-dimensional K -algebras A and B we write $A \sim B$ if the categories $\text{mod}(A)$ and $\text{mod}(B)$ are equivalent. The following theorem is a special case of the Morita-Tachikawa correspondence:

Theorem 1.2 (Auslander correspondence [A74]). *There is a bijection $\{A \mid A \text{ is representation-finite}\} / \sim \longrightarrow \{B \mid \text{dom. dim}(B) \geq 2 \geq \text{gl. dim}(B)\} / \sim$ which sends A to $B := \text{End}_A(M)^{\text{op}}$ with M an additive generator of $\text{mod}(A)$. The inverse sends B to $A := \text{End}_B(Q)^{\text{op}}$ with Q an additive generator of $\text{proj-inj}(B)$.*

Example: Let $A = KQ$, where Q is the quiver

$$1 \longleftarrow 2 \longrightarrow 3$$

Here is the Auslander-Reiten quiver Γ_A (we display modules by their composition factors):

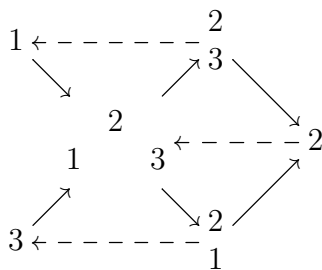

Then

$$M := M_1 \oplus \cdots \oplus M_6 := 1 \oplus \begin{matrix} 2 \\ 1 \end{matrix} \oplus \begin{matrix} 2 \\ 3 \end{matrix} \oplus 3 \oplus \begin{matrix} 2 \\ 3 \end{matrix} \oplus 2 \oplus \begin{matrix} 2 \\ 1 \end{matrix}$$

is an additive generator of $\text{mod}(A)$. Let

$$B := \text{End}_A(M)^{\text{op}}.$$

It follows that $B \cong KQ'/I'$, where Q' is the quiver

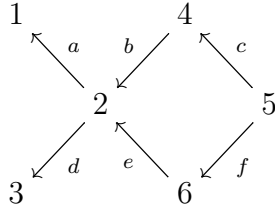

and the ideal I' is generated by $\{ab, de, bc - ef\}$. The B -module

$$Q := P(4) \oplus P(5) \oplus P(6)$$

is an additive generator of $\text{proj-inj}(A)$, and we have

$$A \cong \text{End}_B(Q)^{\text{op}}.$$

1.1.3. *Brauer-Thrall Conjectures and beyond.* The implication (i) \implies (ii) in the following theorem is due to Tachikawa [T73, Corollary 9.5], and the converse (ii) \implies (i) was proved by Auslander [A74].

Theorem 1.3. *The following are equivalent:*

- (i) *A is representation-finite.*
- (ii) *Each $M \in \text{Mod}(A)$ is a direct sum of finite-dimensional indecomposable A -modules.*

The following theorem has been proved by Roiter using the Gabriel-Roiter measure, and later in a strengthened form by Auslander using the Auslander-Reiten quiver and the Harada-Sai Lemma. Both approaches are discussed in [R80].

Theorem 1.4 (Roiter [R68] (1st Brauer-Thrall Conjecture)). *The following are equivalent:*

- (i) *A is representation-finite.*
- (ii) *There exists some $b_A \geq 1$ such that*

$$\text{length}(M) \leq b_A$$
for all $M \in \text{ind}(A)$.

A has **enough large indecomposable modules** if for each infinite cardinal λ there exists an indecomposable A -module of cardinality $\geq \lambda$.

Here is a more general version of the 1st Brauer-Thrall Conjecture which still seems to be open:

Conjecture 1.5 (Simson [Si03]). *If A is representation-infinite, then A has enough large indecomposable modules.*

The following result also has the same flavour as the 1st Brauer-Thrall Conjecture.

Theorem 1.6 (Smalø, Venas [SV98]). *The following are equivalent:*

- (i) A is representation-finite.
- (ii) There exists some $b_A \geq 1$ such that

$$\text{length}({}_B B) \leq b_A$$
 for all $B := \text{End}_A(M)$ with $M \in \text{ind}(A)$.

I learned from Sverre Smalø (Email from 2016) that the following question still seems to be open:

Question 1.7. *Assume that exists some $b_A \geq 1$ such that*

$$\text{Loewy}({}_B B) \leq b_A$$

for all $B := \text{End}_A(M)$ with $M \in \text{ind}(A)$. Does it follow that A is representation-finite?

Here $\text{Loewy}({}_B B)$ denotes the Loewy length of ${}_B B$.

Conjecture 1.8 (2nd Brauer-Thrall Conjecture). *Let K be infinite, and assume that A is representation-infinite. Then there are infinitely many positive integers d such that there are infinitely many isomorphism classes of indecomposable A -modules of length d .*

Smalø [S80] showed that the above conjecture holds provided there is one d such that there are infinitely many isomorphism classes of indecomposable A -modules of length d .

The results in [BGRS85] play a crucial role in the proof of the following result.

Theorem 1.9 (Bautista [B85]). *Assume that K is algebraically closed. Then the 2nd Brauer-Thrall Conjecture is true.*

A detailed treatment of the 2nd Brauer-Thrall Conjecture can be found in [Bo13, Section 7.3] and in [Bo17].

Theorem 1.10 (Bongartz [Bo13b]). *Let K be algebraically closed. Assume that there is an indecomposable A -module of length $n \geq 2$. Then there exists an indecomposable A -module of length $n - 1$.*

Example: This example is due to Ringel. Let $A = KQ$ where Q is the quiver

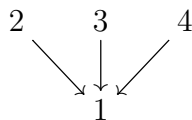

and K is the field with 2 elements. Then Theorem 1.10 does not hold for A .

The following recursive definition is due to Ringel:

All simple A -modules are **accessible**. An A -module of length $d \geq 2$ is **accessible** provided it is indecomposable and it admits an accessible submodule or an accessible factor module of length $d - 1$.

Here is a strengthened version of Theorem 1.10:

Theorem 1.11 (Ringel [R11]). *Let K be algebraically closed. Assume that there is an indecomposable A -module of length n . Then there exists an accessible A -module of length n .*

LITERATURE – REPRESENTATION-FINITE ALGEBRAS

- [A74] M. Auslander, *Representation theory of artin algebras II*. Comm. Algebra 1 (1974), 269–310.
- [BGRS85] R. Bautista, P. Gabriel, A.V. Roiter, L. Salmerón, *Representation-finite algebras and multiplicative bases*. Invent. Math. 81 (1985), no. 2, 217–285.
- [B85] R. Bautista, *On algebras of strongly unbounded representation type*. Comment. Math. Helv. 60 (1985), no. 3, 392–399.
- [Bo13] K. Bongartz *On representation-finite algebras and beyond*. In: Advances in representation theory of algebras, 65–101, EMS Ser. Congr. Rep., Eur. Math. Soc., Zürich, 2013.
- [Bo13b] K. Bongartz, *Indecomposables live in all smaller lengths*. Represent. Theory 17 (2013), 199–225.
- [Bo17] K. Bongartz, *Representation embeddings and the second Brauer-Thrall conjecture*. Preprint, arXiv:1611.02017v4
- [BG81] K. Bongartz, P. Gabriel, *Covering spaces in representation theory*. Invent. Math. 65 (1982), no. 3, 331–378.
- [G81] P. Gabriel, *The universal cover of a representation-finite algebra*. In: Representation Theory I, Proc. Puebla, 1980, in: Lecture Notes in Math., Vol. 903, Springer, 1981, pp. 68–105.
- [R80] C.M. Ringel, *On algorithms for solving vector space problems. I. Report on the Brauer-Thrall conjectures: Rojter’s theorem and the theorem of Nazarova and Rojter*. In: Representation theory, I (Proc. Workshop, Carleton Univ., Ottawa, Ont., 1979), pp. 104–136, Lecture Notes in Math., 831, Springer, Berlin, 1980.
- [R11] C.M. Ringel, *Indecomposables live in all smaller lengths*. Bull. Lond. Math. Soc. 43 (2011), no. 4, 655–660.

- [R68] A. Roiter, *The unboundedness of the dimension of the indecomposable representations of algebras that have an infinite number of indecomposable representations*. Izv. Akad. Nauk SSSR Ser. Math. 32 (1968), 1275–1282. Translation: Math. USSR-Izv. 2 (1968), 1223–1230.
- [Si03] D. Simson, *On large indecomposable modules, Endo-Wild representation type and right pure semisimple rings*. Algebra Discrete Math. 2 (2003), 93–118.
- [S80] S. Smalø, *The inductive step of the second Brauer-Thrall conjecture*. Canad. J. Math. 32 (1980), no. 2, 342–349.
- [SV98] S. Smalø, S. Venas, *Lengths of endomorphism rings of finitely generated indecomposable modules over Artin algebras*. Arch. Math. (Basel) 70 (1998), no. 3, 182–186.
- [T73] H. Tachikawa, *Quasi-Frobenius rings and generalizations. QF-3 and QF-1 rings*. Notes by Claus Michael Ringel. Lecture Notes in Mathematics, Vol. 351. Springer-Verlag, Berlin-New York, 1973. xi+172 pp.

Back to Overview §1 Representation-finite.

1.2. Standard algebras. Let A be a finite-dimensional K -algebra, and let Γ_A be the Auslander-Reiten quiver of A , and let d_A be the associated valuation. For all missing definitions we refer to Section 14.

A is a **standard algebra** if the valuation d_A splits and if the mesh category $K\langle\Gamma_A^e\rangle$ is equivalent to $\text{ind}(A)$.

In this case, each connected component of Γ_A is standard.

Proposition 1.12. *Standard algebras are representation-finite.*

Examples:

- (i) Let $A = KQ$ be a finite-dimensional path algebra. Then A is a standard algebra if and only if Q is a Dynkin quiver.
- (ii) Let $A = K[T]/(T^n)$ for some $n \geq 2$. Then A is a standard algebra.

There are also representation-infinite finite-dimensional algebras A such that each connected component of Γ_A is standard. The easiest example is the path algebra of the Kronecker quiver

$$1 \begin{array}{c} \longleftarrow \\ \longleftarrow \\ \longleftarrow \end{array} 2$$

Let A be representation-finite, and assume that d_A splits. Then A is a **non-standard algebra** if A is not standard.

Proposition 1.13 ([BGRS85]). *Assume that K is algebraically closed. If A is a non-standard K -algebra, then $\text{char}(K) = 2$.*

Let K be algebraically closed, and let A be a non-standard K -algebra. Then there is a unique standard algebra \overline{A} , the **standard form** of A , having an Auslander-Reiten quiver $\Gamma_{\overline{A}}$ isomorphic to Γ_A , see [BrG83]. However, the categories $\text{ind}(A)$ and $\text{ind}(\overline{A})$ are not equivalent.

Example: Let K be algebraically closed with $\text{char}(K) = 2$, and let Q be the quiver

$$c \begin{array}{c} \circlearrowleft \\ \circlearrowright \end{array} 1 \begin{array}{c} \xrightarrow{a} \\ \xleftarrow{b} \end{array} 2$$

Let $I := (c^4, c^2 + ba, ab)$ and $I' := (c^4, c^2 + c^3 + ba, ab)$ be ideals in KQ . Then $A := KQ/I$ is a standard algebra, $A' := KQ/I'$ is a non-standard algebra, and the Auslander-Reiten quivers Γ_A and $\Gamma_{A'}$ are isomorphic, see [Rie83] for this and also for other examples of this kind.

LITERATURE – STANDARD ALGEBRAS

- [BGRS85] R. Bautista, P. Gabriel, A.V. Roiter, L. Salmerón, *Representation-finite algebras and multiplicative bases*. Invent. Math. 81 (1985), no. 2, 217–285.
- [BG82] K. Bongartz, P. Gabriel, *Covering spaces in representation theory*. Invent. Math. 65 (1982) 331–378.
- [B13] K. Bongartz, *On representation-finite algebras and beyond*. In: Advances in representation theory of algebras, 65–101, EMS Ser. Congr. Rep., Eur. Math. Soc., Zürich, 2013.
- [BrG83] O. Breitscher, P. Gabriel, *The standard form of a representation-finite algebra*. Bull. Soc. Math. France 111 (1983), no. 1, 21–40.
- [G81] P. Gabriel, *The universal cover of a representation-finite algebra*. In: Representations of algebras (Puebla, 1980), pp. 68–105, Lecture Notes in Math., 903, Springer, Berlin-New York, 1981.
- [Rie83] C. Riedtmann, *Many algebras with the same Auslander-Reiten quiver*. Bull. London Math. Soc. 15 (1983), no. 1, 43–47.
- [Rie02] C. Riedtmann, *Degenerations for nonstandard algebras*. J. Algebra 255 (2002), 342–345.

Back to Overview §1 Representation-finite.

1.3. Directed algebras. Let A be a finite-dimensional K -algebra. Ringel’s book [R84] is the standard reference for this subsection.

A **path** of length $s \geq 2$ in $\text{mod}(A)$ is a tuple (X_1, X_2, \dots, X_s) of finite-dimensional indecomposable A -modules such that for each $1 \leq i \leq s - 1$ there exists a non-zero and non-invertible homomorphism $X_i \rightarrow X_{i+1}$.

Examples:

- (i) If $X \in \text{ind}(A)$ such that $\text{End}_A(X)$ is not a K -skew-field, then (X, X) is a path of length 2.
- (ii) Let $A = KQ/I$ be a basic algebra, and let $a_1 a_2 \cdots a_m$ be a path in Q . Then $(P(t(a_1)), P(t(a_2)), \dots, P(t(a_m)), P(s(a_m)))$ is a path in $\text{mod}(A)$.

A is a **directed algebra** if there is no path (X_1, X_2, \dots, X_s) of length $s \geq 2$ in $\text{mod}(A)$ with $X_1 \cong X_s$.

Examples:

- (i) Semisimple algebras, path algebra KQ of Dynkin quivers and representation-finite hereditary algebras are directed.
- (ii) Let A be directed. Then any factor algebra A/I is again directed.
- (iii) $A = K[X]/(X^2)$ is representation-finite, but not directed.

Lemma 1.14. *If A is directed, then A is triangular. In particular, $\text{gl. dim}(A) < \infty$.*

Theorem 1.15. *Each directed algebra is representation-finite.*

Theorem 1.16. *The following are equivalent:*

- (i) A is a directed algebra.
- (ii) Each connected component of the Auslander-Reiten quiver Γ_A is a pre-projective component.

Corollary 1.17. *For a directed algebra A , the knitting algorithm computes the Auslander-Reiten quiver Γ_A .*

We say that K is a **splitting field** for A if $\text{End}_A(S) \cong K$ for all simple A -modules S .

For example, this is the case if K is algebraically closed or if $A = KQ/I$ is a basic algebra.

Assume that K is a splitting field for A , and that A is directed. Let (Γ_A, d_A) be the Auslander-Reiten quiver of A . Then the valuation d_A splits.

Corollary 1.18. *Assume that K is a splitting field for A , and that A is directed. Then $\text{ind}(A)$ is equivalent to the mesh category $K\langle \Gamma_A^e \rangle$.*

Proposition 1.19. *If A is directed, then for each $X \in \text{ind}(A)$ the following hold:*

- (i) $\text{End}_A(X)$ is a K -skew-field.
- (ii) $\text{Ext}_A^i(X, X) = 0$ for all $i \geq 1$.

The following theorem is a special case of [ARS97, Section IX, Theorem 1.2]:

Theorem 1.20. *Let A be a directed algebra. For $X, Y \in \text{ind}(A)$ the following are equivalent:*

- (i) $X \cong Y$.
- (ii) $\underline{\dim}(X) = \underline{\dim}(Y)$.

$X \in \text{mod}(A)$ is **sincere** if $[X : S] \neq 0$ for all simple A -modules S .

Proposition 1.21. *Let A be directed, and let $X \in \text{ind}(A)$ be sincere. Then the following hold:*

- (i) $\text{proj. dim}(X) \leq 1$.
- (ii) $\text{inj. dim}(X) \leq 1$.
- (iii) $\text{gl. dim}(A) \leq 2$.

If $\text{gl. dim}(A) < \infty$, then

$$X \mapsto \chi_A(X) := \sum_{i \geq 0} (-1)^i \dim \text{Ext}_A^i(X, X)$$

yields a quadratic form $\chi_A: \mathbb{Z}^n \rightarrow \mathbb{Z}$ where $n = n(A)$ is the number of simple A -modules, up to isomorphism. The value $\chi_A(X)$ only depends on $\underline{\dim}(X)$.

A quadratic form $q: \mathbb{Z}^n \rightarrow \mathbb{Z}$ is **weakly positive** provided $q(x) > 0$ for all $0 \neq x \in \mathbb{N}^n$.

For a proof of the following result we refer to [R84, Section 2.4].

Theorem 1.22. *Assume that K is a splitting field for A . Let A be directed with $\text{gl. dim}(A) \leq 2$. Then χ_A is weakly positive, and*

$$X \mapsto \underline{\dim}(X)$$

yields a bijection between the set of isomorphism classes of indecomposable A -modules and the set

$$\{x \in \mathbb{N}^n \mid \chi_A(x) = 1\}$$

of positive roots of χ_A .

Example: Let $A = KQ/I$ where Q is the quiver

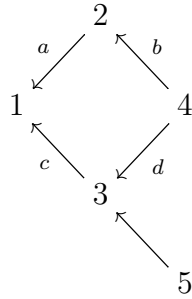

and I is generated by $ab - cd$. Then A is a sincere directed algebra. We have

$$\chi_A = \sum_{i=1}^5 x_i^2 - \sum_{a \in Q_1} x_{s(a)}x_{t(a)} + x_1x_4.$$

Here is the Auslander-Reiten quiver Γ_A (the modules are displayed by their dimension vectors, projectives are red and injectives are blue):

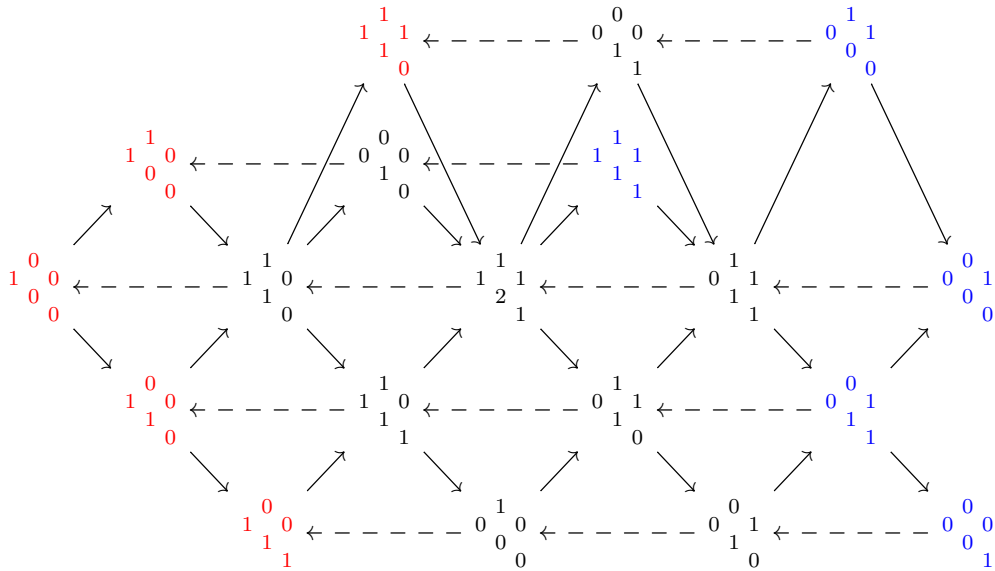

The following is a consequence of the previous theorem together with a result by Ovsienko on roots of quadratic forms. This is explained in [R84].

Theorem 1.23. *Assume that K is a splitting field for A . Let A be a directed, and let $X \in \text{ind}(A)$. Then each entry in $\underline{\dim}(X)$ is at most 6.*

A directed algebra A is **sincere** if there exists a sincere $X \in \text{ind}(A)$.

Theorem 1.24 (Bongartz [B82]). *Let K be algebraically closed. Let A be a sincere directed algebra, and let $n(A) > 13$. Then A belongs to one of 24 infinite families of algebras. Furthermore,*

$$\text{length}(X) \leq 2n(A) + 48$$

for all $X \in \text{ind}(A)$.

The 24 families of sincere directed algebras A with $n(A) > 13$ can also be found in Ringel's book [R84]. The cases with $n(A) \leq 13$ are classified by Dräxler [D89].

LITERATURE – DIRECTED ALGEBRAS

- [ARS97] M. Auslander, I. Reiten, S. Smalø, *Representation theory of Artin algebras*, Corrected reprint of the 1995 original. Cambridge Studies in Advanced Mathematics, 36. Cambridge University Press, Cambridge, 1997. xiv+425 pp.
- [B82] K. Bongartz, *Treue einfach zusammenhängende Algebren. I.* (German) [Faithful simply connected algebras. I] *Comment. Math. Helv.* 57 (1982), no. 2, 282–330.
- [D89] P. Dräxler, *Aufrichtige gerichtete Ausnahmialgebren.* (German) [Exceptional sincere directed algebras] *Bayreuth. Math. Schr. No. 29* (1989), 191 pp.
- [R84] C.M. Ringel, *Tame algebras and integral quadratic forms.* Lecture Notes in Mathematics, 1099. Springer-Verlag, Berlin, 1984. xiii+376 pp.

Back to Overview §1 Representation-finite.

1.4. Distributive algebras. Let A be a finite-dimensional K -algebra.

Let S be a partially ordered set (or *poset* for short). For a subset $T \subseteq S$ an **upper bound** for T is some $s \in S$ such that $t \leq s$ for all $t \in T$. A **supremum** of T is a smallest upper bound s_0 for T , i.e. s_0 is an upper bound and if s is an upper bound for T , then $s_0 \leq s$. Similarly, one defines a **lower bound** and an **infimum** of T .

A poset S is a **lattice** if for any two elements $s, t \in S$ there is a supremum and an infimum of $T = \{s, t\}$. In this case write $s + t$ for the supremum and $s \cap t$ for the infimum.

A lattice S is a **distributive lattice** if

$$s \cap (t + u) = (s \cap t) + (s \cap u)$$

for all $s, t, u \in S$.

It is an easy exercise to show that a lattice S is distributive if and only if

$$s + (t \cap u) = (s + t) \cap (s + u).$$

for all $s, t, u \in S$.

A is a **distributive algebra** if the lattice of two-sided ideals in A is distributive.

Proposition 1.25 (Jans [J57]). *For K infinite, the following are equivalent:*

- (i) A is distributive.
- (ii) The lattice of two-sided ideals in A is finite.

The next result yields an easy method for checking if an algebra is distributive or not.

Proposition 1.26 (Kupisch [K65]). *For a basic algebra $A = KQ/I$ the following are equivalent:*

- (i) A is distributive.
- (ii) For all $i, j \in Q_0$ we have $e_i A e_i \cong K[T]/(T^{m_i})$ for some $m_i \geq 1$, and $e_i A e_j$ is cyclic as an $e_i A e_i$ -module or cyclic as a (right) $e_j A e_j$ -module.

Examples:

- (i) For $n \geq 2$ let $A = KQ/I$ where Q is the quiver

$${}^a \circlearrowleft 1 \xleftarrow{b} 2 \circlearrowright c$$

and I is generated by $\{a^n, ab - bc, c^n\}$. Then A is distributive.

- (ii) Let $A = KQ/I$ be a basic algebra such that $\dim(e_i A e_i) \leq 1$ for all $i \in Q_0$. (For example, this is the case if Q is acyclic.) Then A is distributive if and only if $\dim(e_i A e_j) \leq 1$ for all $i, j \in Q_0$.

Theorem 1.27 (Jans [J57, Theorem 2.1]). *Assume that K is infinite. If A is not distributive, then there is an infinite family of pairwise non-isomorphic finite-dimensional indecomposable A -modules of the same length.*

Corollary 1.28. *Let K be an infinite field. If A is representation-finite, then A is distributive.*

Theorem 1.29 (Ringel [R11]). *Let K be algebraically closed. If A is not distributive it has an accessible module of length d for each $d \geq 1$.*

(The definition of an *accessible module* can be found in Section 1.1.)

The tame distributive algebras with two simple modules have been classified in [DG96].

LITERATURE – DISTRIBUTIVE ALGEBRAS

- [BGRS85] R. Bautista, P. Gabriel, A.V. Roiter, L. Salmerón, *Representation-finite algebras and multiplicative bases*. Invent. Math. 81 (1985), no. 2, 217–285.
- [Bo13] K. Bongartz, *On representation-finite algebras and beyond*. In: Advances in representation theory of algebras, 65–101, EMS Ser. Congr. Rep., Eur. Math. Soc., Zürich, 2013.
- [Bo13b] K. Bongartz, *Indecomposables live in all smaller lengths*. Represent. Theory 17 (2013), 199–225.
- [Bo17] K. Bongartz, *Representation embeddings and the second Brauer-Thrall conjecture*. Preprint, arXiv:1611.02017v4
- [DG96] P. Dräxler, C. Geiß, *On the tameness of certain 2-point algebras*. Representation theory of algebras (Cocoyoc, 1994), 189–199, CMS Conf. Proc., 18, Amer. Math. Soc., Providence, RI, 1996.
- [J57] J. Jans, *On the indecomposable representations of algebras*. Ann. Math. 66 (1957), 418–429.
- [K65] H. Kupisch, *Symmetrische Algebren mit endlich vielen unzerlegbaren Darstellungen. I.* (German) J. Reine Angew. Math. 219 (1965), 1–25.
- [R11] C.M. Ringel, *Indecomposables live in all smaller lengths*. Bull. Lond. Math. Soc. 43 (2011), no. 4, 655–660.

Back to Overview §1 Representation-finite.

2. Tame and wild algebras

§2 Tame and wild algebras:

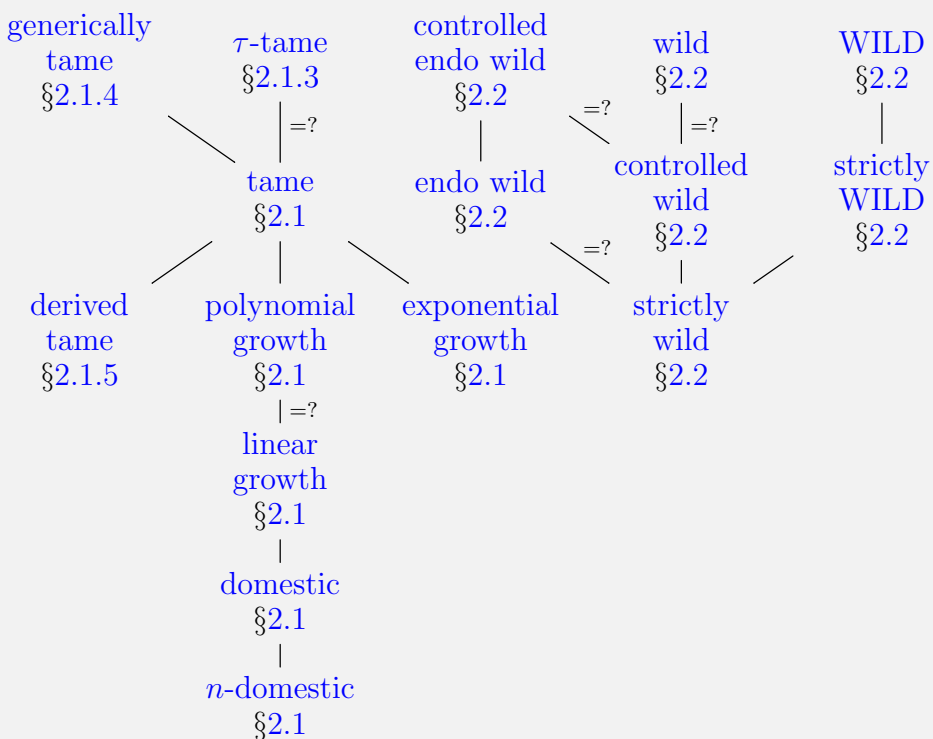

Back to Overview Metaclasses 1.

2.1. **Tame algebras.** Let K be a field, and let A be a finite-dimensional K -algebra.

2.1.1. *Tame algebras.* Let $K[T]$ be the polynomial ring in one variable T .

Assume that K be algebraically closed. The algebra A is **tame** if for each d there exist finitely many A - $K[T]$ -bimodules M_1, \dots, M_t , which are free of finite rank as right $K[T]$ -modules, such that (up to isomorphism) all but finitely many indecomposable d -dimensional A -modules are isomorphic to a module of the form

$$M_i \otimes_{K[T]} S$$

with S a simple $K[T]$ -module.

In this case, let $\mu(d)$ be the minimal number of such bimodules. (Recall that the simple $K[T]$ -modules are of the form $S_\lambda := K[T]/(T - \lambda)$ with $\lambda \in K$, and that $S_\lambda \cong S_\mu$ if and only if $\lambda = \mu$.)

Let $\text{mod}(A, d)$ be the affine variety of d -dimensional A -modules. The group $G = \text{Gl}_d(K)$ acts on $\text{mod}(A, d)$ by conjugation, and the G -orbits correspond to the isomorphism classes of d -dimensional A -modules. Each of the bimodules M_i in the definition of a tame algebra yields a rational curve C_i in $\text{mod}(A, d)$. The curves C_1, \dots, C_t intersect all but finitely many orbits of the d -dimensional indecomposable A -modules.

There is an enormous wealth of publications on tame algebras. However, in contrast to the representation-finite algebras, one cannot speak of a *theory of tame algebras*. As it stands, there are extremely few results on tame algebras in general. Instead, one usually works with special classes of tame algebras.

There is a vague feeling that the known classes of tame algebras (at least morally) cover all tame algebras or (more cautiously) all tame phenomena.

At least in principle, it should be possible to describe the category $\text{mod}(A)$ of any given tame algebra A .

2.1.2. Growth of a tame algebra.

One says that a tame algebra A is

- **domestic** if there exists some $n \geq 0$ with

$$\mu(d) \leq n$$

for all d . For a minimal such n we call A an **n -domestic algebra**.

- of **linear growth** if there exists some $n \geq 1$ such that

$$\mu(d) \leq nd$$

for all d .

- of **polynomial growth** if there exists some $n \geq 1$ such that

$$\mu(d) \leq n^d$$

for all d .

- of **exponential growth** if for each $n \geq 1$ there exists some $d \geq 1$ such that

$$\mu(d) > n^d.$$

Examples: Let K be algebraically closed.

- (i) The path algebra of the Kronecker quiver

$$1 \rightrightarrows 2$$

is tame 1-domestic (and not representation-finite).

- (ii) Tubular algebras are tame of linear growth (and not domestic).

(iii) Let $A = KQ/I$ where Q is the quiver

$$a \begin{array}{c} \curvearrowright \\ \curvearrowleft \end{array} 1 \begin{array}{c} \curvearrowright \\ \curvearrowleft \end{array} b$$

and I is generated by $\{a^3, b^2, ab, ba\}$. Then A is tame of exponential growth (and not of polynomial growth).

(iv) The path algebra of the 3-Kronecker quiver

$$1 \rightrightarrows 2$$

is not tame.

Conjecture 2.1. *The following are equivalent:*

- (i) A is tame of linear growth.
- (ii) A is tame of polynomial growth.

2.1.3. τ -tame algebras.

A finite-dimensional K -algebra A is **τ -tame** if for each d all but finitely many (up to isomorphism) d -dimensional indecomposable A -modules M satisfy

$$\tau(M) \cong M$$

where τ denotes the Auslander-Reiten translation.

Theorem 2.2 (Crawley-Boevey [CB88]). *If A is tame, then A is τ -tame.*

Conjecture 2.3. *If A is τ -tame, then A is tame.*

More on Conjecture 2.3 can be found in [BCBLZ00].

2.1.4. *Generically tame algebras.* As before, let A be a finite-dimensional K -algebra. The length of $M \in \text{Mod}(A)$ is denoted by $\text{length}(M)$. Note that M is also a B -module where $B := \text{End}_A(M)$. Let $\text{endlength}(M)$ be the length of M as a B -module.

The following definition is due to Crawley-Boevey [CB91, CB92].

$M \in \text{Mod}(A)$ is a **generic module** if the following hold:

- (i) M is indecomposable;
- (ii) $\text{length}(M) = \infty$;
- (iii) $\text{endlength}(M) < \infty$.

Example: Let A be the path algebra of the Kronecker quiver

$$1 \rightrightarrows 2$$

and let G be the representation

$$K(T) \begin{array}{c} \xrightarrow{1} \\ \xrightarrow{T} \end{array} K(T)$$

where $K(T)$ is the field of rational functions in one variable T . Then G is a generic A -module.

Theorem 2.4 (Crawley-Boevey [CB91]). *Let K be algebraically closed. Then the following are equivalent:*

- (i) A is representation-infinite.
- (ii) There exists a generic A -module.

The algebra A is **generically tame** if for each d there are only finitely many generic A -modules of endlength d , up to isomorphism.

This version of tameness has the advantage that it does not rely on any assumptions on the ground field K .

Theorem 2.5 (Crawley-Boevey [CB91]). *Let K be algebraically closed. Then the following are equivalent:*

- (i) A is tame.
- (ii) A is generically tame.

The following conjectures are for finite-dimensional K -algebras with K an arbitrary field (the algebraically closed case is covered by Theorems 2.4 and 2.5):

Conjecture 2.6. *The following are equivalent:*

- (i) A is representation-infinite.
- (ii) There exists a generic A -module.

Conjecture 2.7. *The following are equivalent:*

- (i) A is not wild.
- (ii) A is generically tame.

2.1.5. *Derived-tame algebras.* Let K be algebraically closed, and let A be a finite-dimensional K -algebra.

Let $X \in D^b(\text{mod}(A))$ be a bounded complex of finite-dimensional A -modules. The **homological dimension** of X is

$$\text{h-dim}(X) := (\dim(H_i(X)))_i \in \mathbb{N}^{(\mathbb{Z})}$$

Geiß and Krause [GK02] propose the following definition of derived tameness of a finite-dimensional K -algebra.

Assume that K be algebraically closed. The algebra A is **derived tame** if for each $d \in \mathbb{N}^{(\mathbb{Z})}$ there exist finitely many bounded complexes M_1, \dots, M_t of A - $K[T]$ -bimodules, which are free of finite rank as right $K[T]$ -modules, such that (up to isomorphism) all but finitely many indecomposable complexes $X \in D^b(\text{mod}(A))$ with $\text{h-dim}(X) = d$ are isomorphic to a complex of the form

$$M_i \otimes_{K[T]} S$$

with S a simple $K[T]$ -module.

Happel constructed an embedding of triangulated categories

$$D^b(\text{mod}(A)) \rightarrow \underline{\text{mod}}(\widehat{A})$$

where \widehat{A} is the repetitive algebra of A . He also showed that this is a triangle equivalence if and only if $\text{gl. dim}(A) < \infty$. Note that the repetitive algebra \widehat{A} is infinite-dimensional, but the definition of its tameness makes of course sense.

Theorem 2.8 (Geiß, Krause [GK02]). *Assume that $\text{gl. dim}(A) < \infty$. Then the following are equivalent:*

- (i) A is derived tame.
- (ii) \widehat{A} is tame.

The implication (ii) \implies (i) holds also without the assumption $\text{gl. dim}(A) < \infty$.

Some authors call A **derived tame** if \widehat{A} is tame, see for example [P98].

Conjecture 2.9. *If \widehat{A} is tame, then A is derived tame.*

Examples:

- (i) Gentle algebras and skewed-gentle algebras are derived tame.
- (ii) Tubular algebras are derived tame.
- (iii) Let $A = KQ/I$ where Q is the quiver

$$1 \xrightarrow{a} 2 \xrightarrow{b} 3 \xrightarrow{c} 4$$

and let I be generated by cba . Then A is representation-finite. However, A is not derived tame.

2.2. Wild algebras. Let A be a finite-dimensional K -algebra. By $K\langle x, y \rangle$ we denote the free K -algebra in two non-commuting variables x and y .

The K -algebra A is

- **wild** if there exists a faithful exact K -linear functor

$$\text{mod}(K\langle x, y \rangle) \rightarrow \text{mod}(A)$$

which respects indecomposables and reflects isomorphism classes.

- **strictly wild** if there exists a fully faithful exact K -linear functor

$$\text{mod}(K\langle x, y \rangle) \rightarrow \text{mod}(A).$$

- **controlled wild** if there exists a faithful exact K -linear functor

$$F: \text{mod}(K\langle x, y \rangle) \rightarrow \text{mod}(A)$$

and an additive subcategory \mathcal{C} of $\text{mod}(A)$ such that for all $M, N \in \text{mod}(K\langle x, y \rangle)$ we have

$$\text{Hom}_A(F(M), F(N)) = F(\text{Hom}_{K\langle x, y \rangle}(M, N)) \oplus \mathcal{C}(F(M), F(N))$$

where $\mathcal{C}(F(M), F(N))$ is the subspace of $\text{rad}_A(F(M), F(N))$ consisting of all homomorphisms factoring through a module in \mathcal{C} .

- **endo wild** if for each finite-dimensional K -algebra B there exists some $M \in \text{mod}(A)$ with $\text{End}_A(M) \cong B$.
- **controlled endo wild** if for each finite-dimensional K -algebra B there exists some $M \in \text{mod}(A)$ and a nilpotent ideal I of $\text{End}_A(M)$ with $\text{End}_A(M)/I \cong B$.

Examples:

- (i) Wild path algebras are strictly wild.
- (ii) Wild local algebras are never strictly wild.
- (iii) Wild local algebras are controlled wild, see [H01].

Conjecture 2.10. *The following are equivalent:*

- (i) A is wild.
- (ii) A is controlled wild.
- (iii) A is controlled endo wild.

Conjecture 2.11. *The following are equivalent:*

- (i) *A is strictly wild.*
- (ii) *A is endo wild.*

One can show that A is wild if and only if there exists an A - $K\langle x, y \rangle$ -bimodule M , which is free of finite rank as a right $K\langle x, y \rangle$ -module, such that the functor

$$M \otimes_{K\langle x, y \rangle} - : \text{mod}(K\langle x, y \rangle) \rightarrow \text{mod}(A)$$

respects indecomposables and reflects isomorphism classes.

Theorem 2.12 (Brenner [B74]). *For any finitely generated K -algebra B there exists a fully faithful exact K -linear functor*

$$\text{mod}(B) \rightarrow \text{mod}(K\langle x, y \rangle).$$

In other words, the problem of classifying the finite-dimensional modules over a wild algebra A includes the same classification problem for all finitely generated K -algebras B . Even more striking, for a strictly wild algebra A and any finitely generated K -algebra B , the category $\text{mod}(A)$ has a subcategory which is equivalent to $\text{mod}(B)$.

For a proof of the following spectacular theorem we refer to [CB88]. Drozd's original proof (which is only sketched in [D80]) is published in Russian [D77, D79].

Theorem 2.13 (Drozd [D80]). *Let K be algebraically closed. Then A is tame or wild, but not both.*

Getting a deeper understanding of the tame-wild dichotomy is one of the most intriguing problems in the representation theory of finite-dimensional algebras.

There are numerous theorems which describe the representation-finite/tame/wild divide of certain classes of algebras, e.g. path algebras of quivers, incidence algebras, tree algebras. Some details will be mentioned in other sections of the FD-Atlas.

There are notions of wildness which also take the infinite-dimensional modules into account:

For example, the K -algebra A is

- **WILD** if there exists a faithful exact K -linear functor

$$\text{Mod}(K\langle x, y \rangle) \rightarrow \text{Mod}(A)$$

which respects indecomposables and reflects isomorphism classes.

- **strictly WILD** if there exists a fully faithful exact K -linear functor

$$\text{Mod}(K\langle x, y \rangle) \rightarrow \text{Mod}(A).$$

The following implications hold:

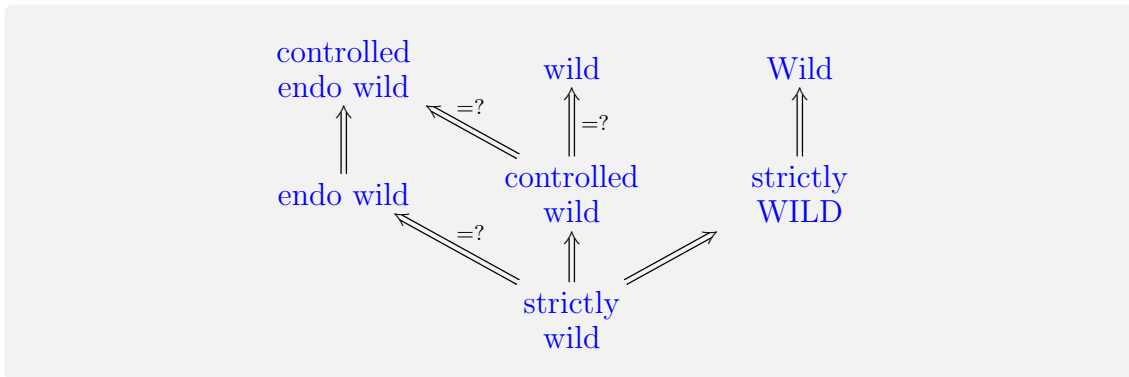

We refer to [S05] for more details.

Example: For $m \geq 2$ let $K(m)$ be the path algebra of the m -Kronecker quiver. (This is the quiver with two vertices 1 and 2 and m arrows $1 \rightarrow 2$.) Then $K(m)$ is strictly wild (and therefore also strictly WILD) for $m \geq 3$.

Ringel [R99] showed that $K(2)$ is strictly WILD, but not wild.

LITERATURE – TAME AND WILD ALGEBRAS

- [BCBLZ00] R. Bautista, W. Crawley-Boevey, T. Lei, Y. Zhang, *On homogeneous exact categories*, J. Algebra 230 (2000), no. 2, 665–675.
- [B74] S. Brenner, *Decomposition properties of some small diagrams of modules*. Symposia Mathematica, Vol. XIII (Convegno di Gruppi Abeliani, INDAM, Rome, 1972), pp. 127–141. Academic Press, London, 1974.
- [CB88] W. Crawley-Boevey, *On tame algebras and bocses*. Proc. London Math. Soc. (3) 56 (1988), no. 3, 451–483.
- [CB91] W. Crawley-Boevey, *Tame algebras and generic modules*, Proc. London Math. Soc., 63 (1991) 241–265.
- [CB92] W. Crawley-Boevey, *Modules of finite length over their endomorphism rings*, In: Representations of Algebras and Related Topics, London Mathematical Society, Lecture Note, vol. 168 (1992) 127–184.
- [D77] Y. Drozd, *On tame and wild matrix problems*. (in Russian), Matrix problems (Institute of Mathematics, Academy of Sciences, Ukrainian SSR, Kiev, 1977), pp. 104–114.

- [D79] Y. Drozd, *Tame and wild matrix problems*. (in Russian), Representations and quadratic forms (Institute of Mathematics, Academy of Sciences, Ukrainian SSR, Kiev, 1979), pp. 39–74.
- [D80] Y. Drozd, *Tame and wild matrix problems*. Representation theory II, Lecture Notes in Mathematics 832 (Springer, Berlin, 1980), pp. 242–258.
- [GK02] C. Geiß, H. Krause, *On the notion of derived tameness*. J. Algebra Appl. 1 (2002), no. 2, 133–157.
- [H01] Y. Han, *Controlled wild algebras*, Proc. London Math. Soc. 83 (2001) 279–298.
- [GNRSV93] P. Gabriel, L. Nazarova, V. Roiter, V. Sergeichuk, D. Vossieck, *Tame and wild subspace problems*. Ukrainian Math. J. 45 (1993), no. 3, 335–372.
- [P98] J.A. de la Peña, *Algebras whose derived category is tame*. In: Trends in the representation theory of finite-dimensional algebras (Seattle, WA, 1997), Amer. Math. Soc., Providence, RI, 1998, pp. 117–127.
- [R99] C.M. Ringel, *Tame algebras are Wild*, Algebra Colloq. 6 (1999) 473–490.
- [R02] C.M. Ringel, *Combinatorial representation theory, History and future*, In: D. Happel, Y.B. Zhang (Eds.), Representations of Algebras, vol. I, Proceedings of the Conference on ICRA IX, Beijing, 2000, Beijing Normal University Press, 2002, pp. 122–144.
- [S05] D. Simson, *On Corner type endo-wild algebras*, J. Pure Appl. Algebra 202 (2005), no. 1-3, 118–132.

[Back to Overview Tame and wild §2.](#)

3. Hereditary algebras

§3 Hereditary algebras:

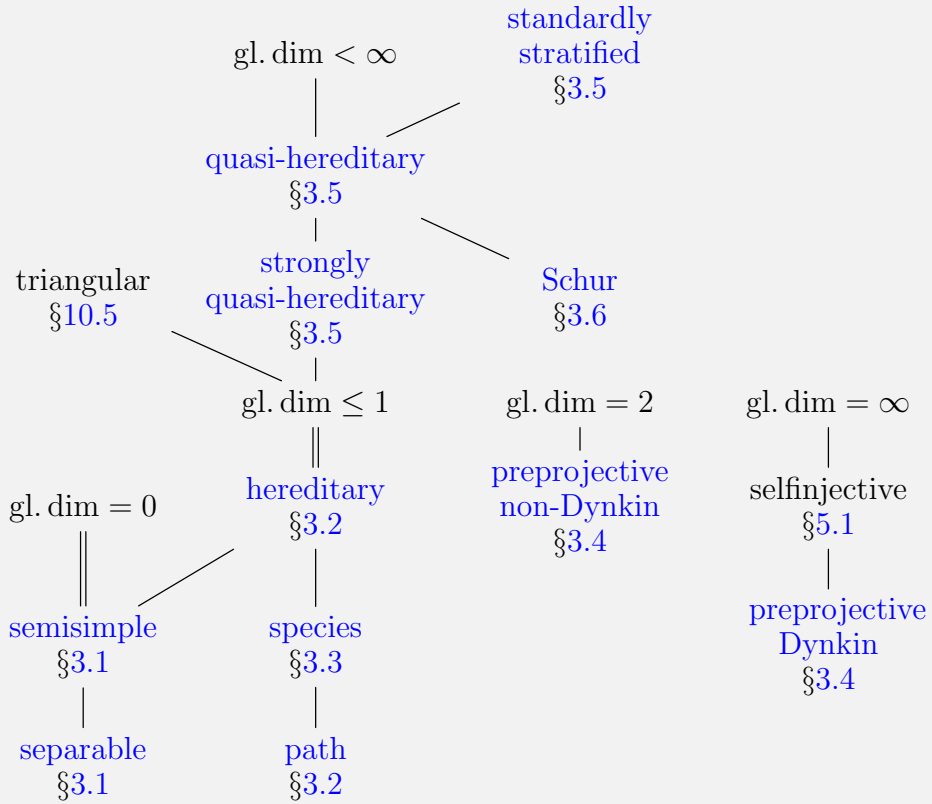

[Back to Overview Metaclasses 1.](#)

Exceptions: Semisimple selfinjective or semisimple preprojective algebras have global dimension 0.

3.1. Semisimple algebras. Let A be a K -algebra.

3.1.1. *Semisimple modules and semisimple algebras.*

An A -module M is **simple** (or **irreducible**) if it contains exactly two submodules, namely 0 and M . A module M is **semisimple** if M is a direct sum of simple modules.

Theorem 3.1. *For an A -module M the following are equivalent:*

- (i) M is semisimple;
- (ii) M is a sum of simple submodules;
- (iii) Every submodule of M is a direct summand.

The proof of Theorem 3.1 uses the Axiom of Choice. This is not surprising: The implication (ii) \implies (i) yields the existence of a basis of a vector space. (We just look at the special case of modules over $A = K$. The simple A -modules are 1-dimensional, and every vector space is a sum of its 1-dimensional subspaces, thus condition (ii) holds.)

Let ${}_A A$ be the regular representation of A , i.e. the algebra A acts on itself by left multiplication.

The algebra A is **semisimple** if all A -modules are semisimple.

Theorem 3.2 (Wedderburn [W08]). *Let A be a K -algebra. Then the following are equivalent:*

- (i) A is a semisimple algebra;
- (ii) ${}_A A$ is a semisimple module;
- (iii) $\text{gl. dim}(A) = 0$;
- (iv) There exist K -skew fields D_i and natural numbers n_i with $1 \leq i \leq s$ such that

$$A \cong \prod_{i=1}^s M_{n_i}(D_i).$$

The opposite algebra A^{op} of a semisimple algebra A is again semisimple.

A semisimple algebra

$$A \cong \prod_{i=1}^s M_{n_i}(D_i)$$

is infinite-dimensional if and only if at least one of the K -skew fields D_i is infinite-dimensional. If A is finite-dimensional and K is algebraically closed, then $D_i = K$ for all i .

Let $A = M_n(D)$ for some K -skew field D and some $n \geq 1$. Let $S = D^n$. We treat the elements of D^n as column vectors. Then S is a simple A -module with A acting from the left by matrix multiplication. Furthermore, we have $\text{End}_A(S) \cong D^{\text{op}}$. It follows that ${}_A A \cong S^n$. By the theorem, every A -module is isomorphic to a direct sum of copies of S .

If

$$A \cong \prod_{i=1}^s M_{n_i}(D_i),$$

then there are exactly s isomorphism classes of simple A -modules.

3.1.2. *Superdecomposable modules.* Finite products of semisimple algebras are again semisimple. Infinite products however behave differently: Let I be an infinite set, and let

$$A := \prod_{i \in I} K_i$$

be the product of copies K_i of our field K . This is a K -algebra with componentwise addition and multiplication. The A -module

$$U_{\text{fin}} := \bigoplus_{i \in I} K_i$$

is a submodule of the regular representation ${}_A A$. Define

$$U_{\infty} := {}_A A / U_{\text{fin}}.$$

A module is called **superdecomposable** provided it is non-zero and has no indecomposable direct summands.

Proposition 3.3. *U_{∞} is superdecomposable.*

3.1.3. *Separable algebras.* Assume now that A is a finite-dimensional K -algebra.

The algebra

$$A^e := A \otimes_K A^{\text{op}}$$

is the **enveloping algebra** of A .

A is **separable** if A is projective as an A^e -module.

Proposition 3.4 ([SY11, Proposition 11.8]). *Separable algebras are semisimple.*

Proposition 3.5 ([SY11, Theorem 11.11]). *A is separable if and only if A^e is semisimple.*

Proposition 3.6 ([SY11, Corollary 11.12]). *If K is a perfect field (e.g. if K is algebraically closed) and A is semisimple, then A is separable.*

LITERATURE – SEMISIMPLE ALGEBRAS

- [RSch20] C. Ringel, J. Schröer, *Representation theory of algebra I: Foundations*. Lecture notes (2020).
 [SY11] A. Skowroński, K. Yamagata, *Frobenius algebras. I. Basic representation theory*. EMS Textbooks in Mathematics. European Mathematical Society (EMS), Zrich, 2011. xii+650 pp.
 [W08] J. Wedderburn, *On Hypercomplex Numbers*. Proc. London Math. Soc. (2) 6 (1908), 77–118.

[Back to Overview Hereditary 3.](#)

3.2. Hereditary algebras.

3.2.1. Hereditary algebras.

A K -algebra A is called **hereditary** if submodules of projective A -modules are again projective.

Finite-dimensional hereditary K -algebras together with their close relatives (e.g. the preprojective algebras) form arguably the single most important class of finite-dimensional K -algebras. There are numerous deep links between the representation theory of hereditary algebras and different areas of mathematics and mathematical physics.

Proposition 3.7. *For a K -algebra A the following are equivalent:*

- (i) A is hereditary;
- (ii) $\text{gl. dim}(A) \leq 1$.

Examples:

- (i) Let Q be a quiver. Then the path algebra KQ is hereditary. A path algebra KQ is finite-dimensional if and only if Q is acyclic. Path algebras are the most studied and best understood class of hereditary algebras.
- (ii) Let \mathcal{M} be an acyclic K -modulated graph. Then the tensor algebra $T(\mathcal{M})$ is a finite-dimensional hereditary K -algebra.

For an acyclic quiver Q , the path algebra KQ is isomorphic to $T(\mathcal{M})$ for some acyclic K -modulated graph \mathcal{M} .

Theorem 3.8. *Let A be a finite-dimensional hereditary K -algebra. Then the following hold:*

- (i) *If A is representation-finite, then A is Morita equivalent to $T(\mathcal{M})$ for some acyclic modulated graph \mathcal{M} .*
- (ii) *If the field K is perfect, then A is Morita equivalent to $T(\mathcal{M})$ for some acyclic modulated graph \mathcal{M} .*
- (iii) *If the field K is algebraically closed, then A is Morita equivalent to KQ for some acyclic quiver Q .*

A proof of Theorem 3.8(i) can be found in [?, Theorem C].

There are examples of finite-dimensional hereditary K -algebras which are not Morita equivalent to any of the tensor algebras $T(\mathcal{M})$.

3.2.2. Representation types of hereditary algebras. In this subsection, let A be a finite-dimensional hereditary K -algebra. Let $S(1), \dots, S(n)$ be the simple A -modules, up to isomorphism.

Since A is hereditary, we can assume without loss of generality that $\text{Ext}_A^1(S(i), S(j)) = 0$ for all $i \geq j$.

Let $C := (c_{ij})$ be the **symmetrizable generalized Cartan matrix** associated with A , where

$$c_{ij} := -\dim_{\text{End}_A(S(i))^{\text{op}}} \text{Ext}_A^1(S(i), S(j)) \text{ and } c_{ji} := -\dim_{\text{End}_A(S(j))} \text{Ext}_A^1(S(i), S(j))$$

for $i < j$, and $c_{ii} := 2$. Let $D := (c_1, \dots, c_n)$ be the **symmetrizer** of C where $c_i := \dim_K \text{End}_A(S(i))$.

The **Tits form** of A is the quadratic form $q = q_{C,D}: \mathbb{Z}^n \rightarrow \mathbb{Z}$ defined by

$$q := \sum_{i=1}^n c_i x_i^2 + \sum_{i < j} c_i c_{ij} x_i x_j.$$

Proposition 3.9. *For $X \in \text{mod}(A)$ we have*

$$q(\underline{\dim}(X)) = \dim \text{End}_A(X) - \dim \text{Ext}_A^1(X, X).$$

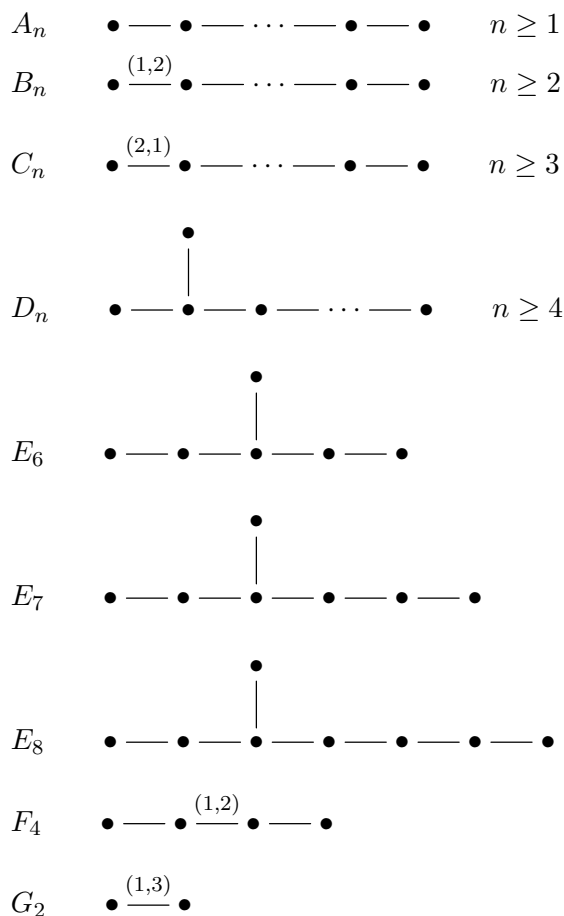

FIGURE 1. Dynkin graphs

The **valued graph** $\Gamma(C)$ of C has vertices $1, \dots, n$ and an (unoriented) edge between i and j if and only if $c_{ij} < 0$. An edge $i - j$ has the **value** $(|c_{ji}|, |c_{ij}|)$. In this case, we display this valued edge as

$$i \xrightarrow{(|c_{ji}|, |c_{ij}|)} j.$$

We just write $i - j$ if $(|c_{ji}|, |c_{ij}|) = (1, 1)$.

The matrix C is **connected** if $\Gamma(C)$ is a connected graph.

From now on, we assume additionally that C is connected.

Figure 1 shows a list of valued graphs called **Dynkin graphs**. By definition each of the graphs A_n , B_n , C_n and D_n has n vertices. The graphs A_n , D_n , E_6 , E_7 and E_8 are the **simply laced Dynkin graphs**.

In Figure 2 we display a list of valued graphs called **Euclidean graphs**. By definition each of the graphs \tilde{A}_n , \tilde{B}_n , \tilde{C}_n , \tilde{D}_n , \widetilde{BC}_n , \widetilde{BD}_n and \widetilde{CD}_n has $n + 1$

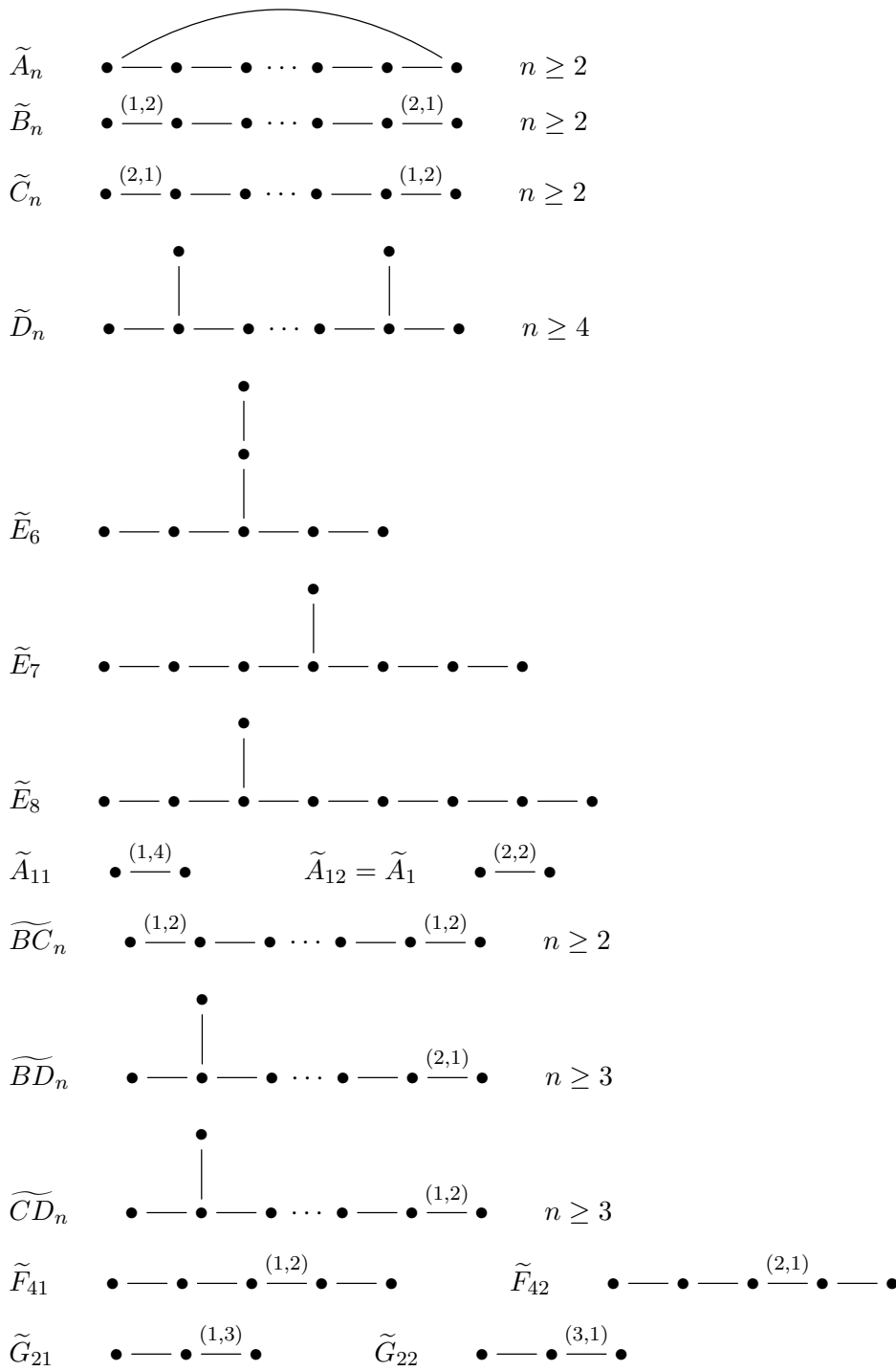

FIGURE 2. Euclidean graphs

vertices. The graphs \tilde{A}_n , \tilde{D}_n , \tilde{E}_6 , \tilde{E}_7 and \tilde{E}_8 are the **simply laced Euclidean graphs**.

The Tits form q is **positive definite** if $q(\alpha) > 0$ for all $0 \neq \alpha \in \mathbb{Z}^n$, and q is **positive semidefinite** if $q(\alpha) \geq 0$ for all $\alpha \in \mathbb{Z}^n$ and q is not positive definite. Otherwise, q is **indefinite**.

Theorem 3.10. *For a finite-dimensional connected hereditary K -algebra A the following hold:*

- (i) A is representation-finite $\iff \Gamma(C)$ is a Dynkin graph $\iff q$ is positive definite.
- (ii) A is tame $\iff \Gamma(C)$ is a Euclidean graph $\iff q$ is positive semi-definite.
- (iii) A is wild $\iff q$ is indefinite.

In case (i), A is a directed algebra, and the AR quiver Γ_A consists of a single preprojective component.

In case (ii), we use the term *tame* in the sense that A is not representation-finite and not wild. (Recall that we defined tame algebras only for K -algebras where K is algebraically closed.) In this case, Γ_A consists of a preprojective component, a preinjective component, and an infinite family of regular components of type $\mathbb{Z}A_\infty/(\tau^m)$ for some $m \geq 1$. There are at most 3 regular components with $m \geq 2$. If K is algebraically closed, these regular components are parametrized by the projective line $\mathbb{P}^1(K)$.

In case (iii), Γ_A consists of a preprojective component, a preinjective component, and an infinite family of regular components of type $\mathbb{Z}A_\infty$. There is no known meaningful way to parametrize the regular components.

3.2.3. Quivers and path algebras.

A **quiver** is a quadruple $Q = (Q_0, Q_1, s, t)$ where Q_0 and Q_1 are finite sets and $s, t: Q_1 \rightarrow Q_0$ are maps.

The elements in Q_0 are called **vertices**, and the elements in Q_1 are **arrows**. Let $a \in Q_1$. Then $s(a)$ is the **starting vertex** and $t(a)$ is the **terminal vertex** of a . One usually draws an arrow $a \in Q_1$ as

$$s(a) \xrightarrow{a} t(a)$$

Thus Q is a finite directed graph. But note that multiple arrows and loops (a **loop** is an arrow a with $s(a) = t(a)$) are allowed.

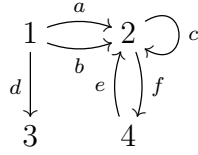

Let $Q = (Q_0, Q_1, s, t)$ be a quiver. A sequence

$$a = (a_1, a_2, \dots, a_m)$$

of arrows $a_i \in Q_1$ is a **path** in Q if $s(a_i) = t(a_{i+1})$ for all $1 \leq i \leq m - 1$. In this case, $\text{length}(a) := m$ is the **length** of a . Furthermore set $s(a) = s(a_m)$ and $t(a) = t(a_1)$.

$$t(a) \xleftarrow{a_1} \xleftarrow{a_2} \dots \xleftarrow{a_m} s(a)$$

Instead of (a_1, a_2, \dots, a_m) one often just writes $a_1 a_2 \dots a_m$. Additionally there is a path e_i of length 0 for each vertex $i \in Q_0$. Let $s(e_i) = t(e_i) = i$.

A path a **starts in** $s(a)$ and **ends in** $t(a)$.

A path a of length $m \geq 1$ is an **oriented cycle** in Q if $s(a) = t(a)$. The quiver Q is **acyclic** if there is no oriented cycles in Q .

The **path algebra** KQ of Q over K is the K -algebra with basis (indexed by) the set of all paths in Q . The multiplication of paths a and b is defined as follows: If $a = (a_1, \dots, a_l)$ and $b = (b_1, \dots, b_m)$ are paths in Q with $l, m \geq 1$, then

$$ab := a \cdot b := \begin{cases} (a_1, \dots, a_l, b_1, \dots, b_m) & \text{if } s(a_l) = t(b_1), \\ 0 & \text{otherwise.} \end{cases}$$

If a or b is a path of length 0, then

$$ab := a \cdot b := \begin{cases} a & \text{if } b = e_i \text{ and } s(a) = i, \\ b & \text{if } a = e_i \text{ and } t(b) = i, \\ 0 & \text{otherwise.} \end{cases}$$

These multiplication rules are clearly associative, so extending them K -linearly turns KQ into a K -algebra.

KQ is finite-dimensional if and only if Q is acyclic.

By definition we have

$$e_i e_j = \begin{cases} e_i & \text{if } i = j, \\ 0 & \text{otherwise.} \end{cases}$$

A **homomorphism**

$$f = (f_i): V \rightarrow W$$

between representations $V = (V_i, V_a)$ and $W = (W_i, W_a)$ is given by a linear map

$$f_i: V_i \rightarrow W_i$$

for each $i \in Q_0$ such that the diagram

$$\begin{array}{ccc} V_{s(a)} & \xrightarrow{V_a} & V_{t(a)} \\ f_{s(a)} \downarrow & & \downarrow f_{t(a)} \\ W_{s(a)} & \xrightarrow{W_a} & W_{t(a)} \end{array}$$

commutes for each $a \in Q_1$.

A homomorphism $f = (f_i)_i: V \rightarrow W$ of representations of Q is an **isomorphism** if each f_i is an isomorphism. In this case, we write $V \cong W$.

The homomorphisms $f: V \rightarrow W$ between representations V and W of a quiver Q form a K -vector space which is denoted by $\text{Hom}_Q(V, W)$.

Examples: Let Q be the Kronecker quiver

$$1 \xleftarrow{\quad} 2$$

For $\lambda_1, \lambda_2 \in K$ let M_{λ_1, λ_2} be the representation

$$K \xleftarrow[\lambda_2]{\lambda_1} K$$

Then

$$\text{Hom}_Q(M_{\lambda_1, \lambda_2}, M_{\mu_1, \mu_2}) = \{f = (f_1, f_2) \mid f_1 \lambda_1 = \mu_1 f_2 \text{ and } f_1 \lambda_2 = \mu_2 f_2\}.$$

$$\begin{array}{ccc} K & \xleftarrow[\lambda_2]{\lambda_1} & K \\ f_1 \downarrow & & \downarrow f_2 \\ K & \xleftarrow[\mu_2]{\mu_1} & K \end{array}$$

It follows that $M_{\lambda_1, \lambda_2} \cong M_{\mu_1, \mu_2}$ if and only if $(\lambda_1, \lambda_2) = c(\mu_1, \mu_2)$ for some $c \in K^*$.

A **subrepresentation** of a representation $V = (V_i, V_a)$ is given by a tuple $(U_i)_i$ of subspaces $U_i \subseteq V_i$ such that

$$V_a(U_{s(a)}) \subseteq U_{t(a)}$$

for all $a \in Q_1$.

The representations of a quiver Q form an abelian K -category $\text{Rep}(Q)$. The full subcategory of finite-dimensional representations is denoted by $\text{rep}(Q)$.

Proposition 3.12. *Let Q be a quiver. Then there is an equivalence*

$$F: \text{Mod}(KQ) \rightarrow \text{Rep}(Q).$$

Construction of F : For a KQ -module V and $i \in Q_0$ define $V_i := e_i V$. This yields a direct decomposition

$$V = \bigoplus_{i \in Q_0} V_i$$

of K -vector spaces. For $a \in Q_1$ define

$$\begin{aligned} V_a: V_{s(a)} &\rightarrow V_{t(a)} \\ v &\mapsto av. \end{aligned}$$

(Note that $a = e_{t(a)} a e_{s(a)}$.) This gives a representation (V_i, V_a) of Q . Define $F(V) := (V_i, V_a)$.

The equivalence in the proposition restricts to an equivalence

$$\text{mod}(KQ) \rightarrow \text{rep}(Q).$$

The functor F is almost an isomorphism of categories. (If we identify internal and external direct sums, we get a bijection on the classes of objects.)

Often one does not distinguish between KQ -modules and representations of Q .

3.2.5. Representation types of quivers. For a quiver $Q = (Q_0, Q_1, s, t)$ the underlying graph $|Q|$ of Q has Q_0 as a set of vertices, and for $i, j \in Q_0$ there are $q_{ij} := |\{a \in Q_1 \mid \{s(a), t(a)\} = \{i, j\}\}|$ unoriented edges connecting i and j .

Q is a **Dynkin quiver** if $|Q|$ is one of the graphs in Figure 3 (the graphs A_n and D_n have n vertices).

Q is a **Euclidean quiver** if $|Q|$ is one of the graphs in Figure 4 (the graphs \tilde{A}_n and \tilde{D}_n have $n + 1$ vertices).

Theorem 3.13. *Let $A = KQ$ be a finite-dimensional connected path algebra. Then the following hold:*

- (i) KQ is representation-finite $\iff Q$ is a Dynkin quiver $\iff q_Q$ is positive definite.
- (ii) KQ is tame $\iff Q$ is a Euclidean quiver. $\iff q_Q$ is positive semidefinite.
- (iii) KQ is wild $\iff q_Q$ is indefinite.

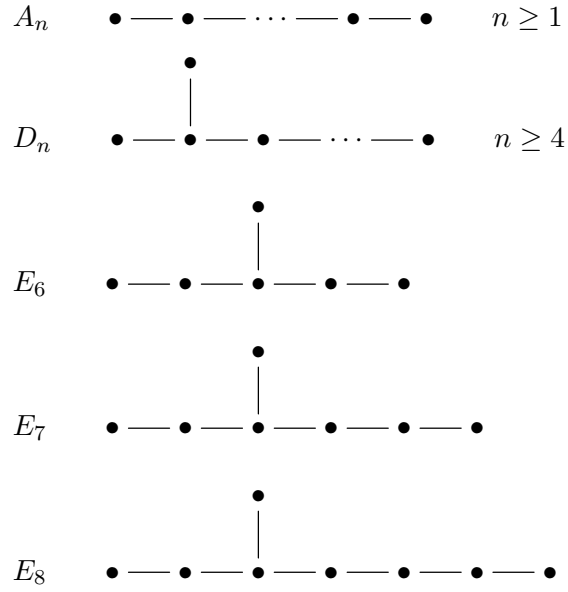

FIGURE 3. Dynkin quivers

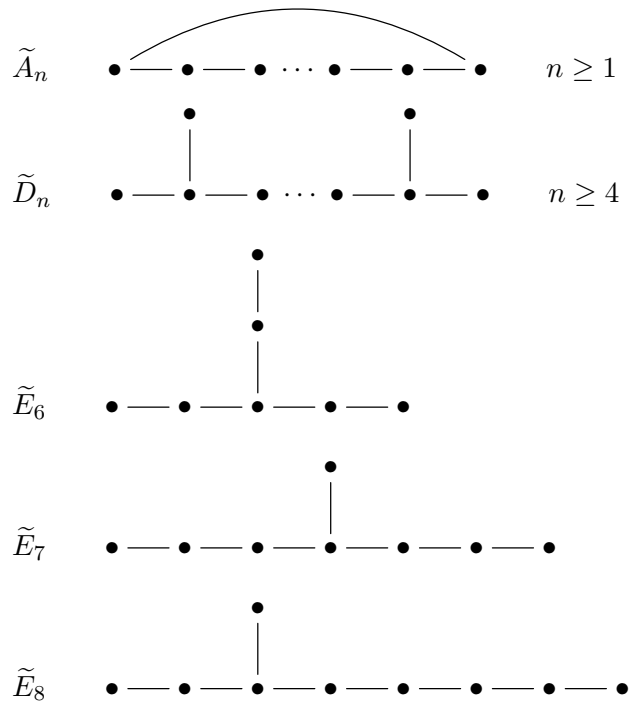

FIGURE 4. Euclidean quivers

In (i) we have

$$\{\underline{\dim}(X) \mid X \in \text{ind}(KQ)\} = \{x \in \mathbb{Z}^n \mid q_Q(x) = 1\} = \Phi_{\text{re}}^+$$

and in (ii) we have

$$\{\dim(X) \mid X \in \text{ind}(KQ)\} = \{x \in \mathbb{Z}^n \mid q_Q(x) = 0, 1\} = \Phi_{\text{re}}^+.$$

(Here ϕ_{re}^+ is the set of positive roots of the Kac-Moody Lie algebra associated with Q , see the next subsection.)

3.2.6. Kac's Theorem. In this section, we assume that K is algebraically closed. Let Q be a quiver with vertices $\{1, \dots, n\}$, and let $A = KQ$. Recall that we can identify $\text{mod}(A)$ and $\text{rep}(Q)$.

For $\alpha, \beta \in \mathbb{Z}^n$ we define

$$\langle \alpha, \beta \rangle := \sum_{i=1}^n \alpha_i \beta_i - \sum_{a \in Q_1} \alpha_{s(a)} \beta_{t(a)}$$

and

$$(\alpha, \beta) := \langle \alpha, \beta \rangle + \langle \beta, \alpha \rangle.$$

Let $q = q_{C,D}: \mathbb{Z}^n \rightarrow \mathbb{Z}$ be the Tits form of A . We have $D = (1, \dots, 1)$ and $c_{ij} = c_{ji}$ for all i, j . It follows that $q(x) = \langle x, x \rangle$ for all $x \in \mathbb{Z}^n$.

The standard basis vector $e_i \in \mathbb{Z}^n$ is a **simple root** if there is no loop at i . In this case, define

$$\begin{aligned} s_i: \mathbb{Z}^n &\rightarrow \mathbb{Z}^n \\ \alpha &\mapsto \alpha - (\alpha, e_i)e_i. \end{aligned}$$

Let $W := \langle s_i \mid e_i \text{ is a simple root} \rangle$ be the **Weyl group**.

Then

$$\Phi_{\text{re}}^+ := \{w(e_i) \mid e_i \text{ simple root, } w \in W\} \cap \mathbb{N}^n$$

is the set of **positive real roots** of Q .

The **support** of $x = (x_1, \dots, x_n) \in \mathbb{Z}^n$ is defined as $\text{supp}(x) := \{1 \leq i \leq n \mid x_i \neq 0\}$. Let $\text{supp}_Q(x)$ be the full subquiver of Q with vertices in $\text{supp}(x)$.

Let

$$F := \{\alpha \in \mathbb{N}^n \mid \alpha \neq 0, \text{supp}_Q(\alpha) \text{ is connected, } (\alpha, e_i) \leq 0 \text{ for all simple roots } e_i\}$$

be the **fundamental region** of Q .

Let

$$\Phi_{\text{im}}^+ := \{w(F) \mid w \in W\} \cap \mathbb{N}^n$$

be the set of **positive imaginary roots** of Q .

For $\alpha \in \Phi_{\text{re}}^+$ (resp. $\alpha \in \Phi_{\text{im}}^+$) we have $q(\alpha) = 1$ (resp. $q(\alpha) \leq 0$).

For $\alpha \in \mathbb{N}^n$ let

$$X := \text{rep}(Q, \alpha) := \prod_{a \in Q_1} \text{Hom}_K(K^{\alpha_{s(a)}}, K^{\alpha_{t(a)}}) \quad \text{and} \quad G := \prod_{i=1}^n \text{GL}_{\alpha_i}(K).$$

Then G acts on X by conjugation:

For $g = (g_1, \dots, g_n) \in G$ and $x = (x_a)_a \in X$ let

$$gx := (g_{t(a)}^{-1} x_a g_{s(a)})_a \in X,$$

and let

$$Gx := \{gx \mid g \in G\}$$

be the **orbit** of x .

For $x, y \in X$ we have $x \cong y$ if and only if $Gx = Gy$.

For $s \geq 0$ let $X_s := \{x \in X \mid \dim Gx = s\}$.

This is locally closed in X .

Let $Y \subseteq X$ be constructible and G -stable. Let

$$\mu(Y) := \max\{\dim(Y \cap X_s) - s \mid s \geq 0\}$$

be the **number of parameters** of Y in X .

Let $\text{ind}(Q, \alpha)$ be the indecomposable representations in $X = \text{rep}(Q, \alpha)$, and let

$$\mu(\alpha) := \mu(\text{ind}(Q, \alpha)).$$

Theorem 3.14 (Kac [Ka80, Ka82]). *For $\alpha \in \mathbb{N}^n$ we have $\text{ind}(Q, \alpha) \neq \emptyset$ if and only if $\alpha \in \Phi_{\text{re}}^+ \cup \Phi_{\text{im}}^+$. In this case,*

$$\mu(\alpha) = 1 - q(\alpha).$$

For $\alpha \in \Phi_{\text{re}}^+$, $\text{ind}(Q, \alpha)$ consists of one orbit.

For arbitrary ground fields K , an analogue of Kac's Theorem is still missing.

One can associate a symmetric Kac-Moody Lie algebra \mathfrak{g} to Q . (This does not depend on the orientation of Q .) The set of positive roots of \mathfrak{g} is $\Phi_{\text{re}}^+ \cup \Phi_{\text{im}}^+$. For a Dynkin quiver Q , \mathfrak{g} is a simple finite-dimensional Lie algebra. For more details we refer to Kac's book [Ka85].

There are numerous deep results which relate the representation theory of Q with the representation theory of \mathfrak{g} .

To be continued...

3.2.7. Schur roots. [Sch92]

To be continued...

3.2.8. Tree modules. [P12, W10, W12]

To be continued...

3.2.9. Crawley-Boevey-Kerner bijections. [CBK94]

To be continued...

LITERATURE – HEREDITARY ALGEBRAS

- [BGP82] I.N. Bernstein, I.M. Gelfand, V.A. Ponomarev, *Coxeter functors, and Gabriel's theorem*. In: I.M. Gelfand (Hrsg.), *Representation theory : selected papers*, 157–172. Cambridge Univ. Press, 1982, London Mathematical Society lecture note series; 69
(Classifies the quivers of finite representation type with a different method than the one used by Gabriel. A milestone!)
- [CB] W. Crawley-Boevey, *Lectures on representations of quivers*. This is not published but can be found on Crawley-Boevey's webpage.
(A graduate course given in 1992 at Oxford University. This is an introduction to the representation theory of quivers, and in particular the representation theory of extended Dynkin quivers. Very well written (but you have to spend some time thinking about some steps in the proofs)).
- [CB92] W. Crawley-Boevey, *Exceptional sequences of representations of quivers*. Proceedings of the Sixth International Conference on Representations of Algebras (Ottawa, ON, 1992), 7 pp., Carleton-Ottawa Math. Lecture Note Ser., 14, Carleton Univ., Ottawa, ON, 1992.
- [CBK94] W. Crawley-Boevey, O. Kerner, *A functor between categories of regular modules for wild hereditary algebras*. Math. Ann. 298 (1994), no. 3, 481–487.
- [CBVdB04] W. Crawley-Boevey, M. Van den Bergh, *Absolutely indecomposable representations and Kac-Moody Lie algebras*. With an appendix by Hiraku Nakajima. Invent. Math. 155 (2004), no. 3, 537–559.
- [G72] P. Gabriel, *Unzerlegbare Darstellungen. I.* (German. English summary). Manuscripta Math. 6 (1972), 71–103; correction, *ibid.* 6 (1972), 309.
(Classifies the quivers of finite representation type. One of the starting points of representation theory of finite-dimensional algebras.)
- [H10] T. Hausel, *Kac's conjecture from Nakajima quiver varieties*. Invent. Math. 181 (2010), no. 1, 21–37.
- [HLRV13] T. Hausel, E. Letellier, F. Rodriguez-Villegas, *Positivity for Kac polynomials and DT-invariants of quivers*. Ann. of Math. (2) 177 (2013), no. 3, 1147–1168.
- [Ka80] V. Kac, *Infinite root systems, representations of graphs and invariant theory*. Invent. Math. 56 (1980), no. 1, 57–92.
- [Ka82] V. Kac, *Infinite root systems, representations of graphs and invariant theory. II.* J. Algebra 78 (1982), no. 1, 141–162.

- [Ka85] V. Kac, *Infinite-dimensional Lie algebras*. Second edition. Cambridge University Press, Cambridge, 1985. xviii+280 pp.
(The two papers above establish a bijection between the set of dimension vectors of the indecomposable representations of a quiver and the set of positive roots of the Kac-Moody Lie algebra associated to the quiver. Plus other results concerning how to parametrize indecomposable representations. A milestone!)
- [K96] O. Kerner, *Representations of wild quivers*. Representation theory of algebras and related topics (Mexico City, 1994), 65–107, CMS Conf. Proc., 19, Amer. Math. Soc., Providence, RI, 1996.
(A very good survey on the representation theory of wild quivers and path algebras.)
- [K98] O. Kerner, *Basic results on wild hereditary algebras*. Trends in the representation theory of finite-dimensional algebras (Seattle, WA, 1997), 215–225, Contemp. Math., 229, Amer. Math. Soc., Providence, RI, 1998.
- [P12] W. Peternell, *Über erreichbare und baumartige unzerlegbare Darstellungen von Köchern*. Diploma Thesis, Wuppertal 2012.
- [Re04] M. Reineke, *The use of geometric and quantum group techniques for wild quivers*. Representations of finite dimensional algebras and related topics in Lie theory and geometry, 365–390, Fields Inst. Commun. 40, Amer. Math. Soc., 2004.
- [R94] C.M. Ringel, *The braid group action on the set of exceptional sequences of a hereditary Artin algebra*. Abelian group theory and related topics (Oberwolfach, 1993), 339–352, Contemp. Math., 171, Amer. Math. Soc., Providence, RI, 1994.
- [R98] C.M. Ringel, *Exceptional modules are tree modules*. Proceedings of the Sixth Conference of the International Linear Algebra Society (Chemnitz, 1996), Linear Algebra Appl. 275/276 (1998), 471–493.
- [Sch92] A. Schofield, *General representations of quivers*. Proc. London Math. Soc. (3) 65 (1992), no. 1, 46–64.
(Gives an algorithm to compute the canonical decomposition of a dimension vector of a quiver. A milestone!)
- [W10] T. Weist, *Tree modules of the generalized Kronecker quiver*. J. Algebra 323 (2010), no. 4, 1107–1138.
- [W12] T. Weist, *Tree modules*. Bull. Lond. Math. Soc. 44 (2012), no. 5, 882–898.

3.3. Species. The representation theory of species and modulated graphs is based on an idea by Gabriel [G73] and has been developed by Dlab and Ringel [DR75, DR76, R76]. For an extension of this framework we refer to [GLS17, GLS20, K17].

A matrix $C = (c_{ij}) \in M_n(\mathbb{Z})$ is a **symmetrizable generalized Cartan matrix** provided the following hold:

- (C1) $c_{ii} = 2$ for all i ;
- (C2) $c_{ij} \leq 0$ for all $i \neq j$;
- (C3) $c_{ij} \neq 0$ if and only if $c_{ji} \neq 0$.
- (C4) There is some integer tuple $D = (c_1, \dots, c_n)$ with $c_i \geq 1$ and $c_i c_{ij} = c_j c_{ji}$ for all i, j .

The tuple D appearing in (C4) is called a **symmetrizer** of C . The symmetrizer D is **minimal** if $c_1 + \dots + c_n$ is minimal.

Let $C = (c_{ij}) \in M_n(\mathbb{Z})$ be a symmetrizable generalized Cartan matrix, and let $D = (c_1, \dots, c_n)$ be a symmetrizer of C . The **valued graph** $\Gamma(C)$ of C has vertices

$1, \dots, n$ and an (unoriented) edge between i and j if and only if $c_{ij} < 0$. An edge $i \text{ --- } j$ has **value** $(|c_{ji}|, |c_{ij}|)$. We display this valued edge as

$$i \xrightarrow{(|c_{ji}|, |c_{ij}|)} j$$

and we just write $i \text{ --- } j$ if $(|c_{ji}|, |c_{ij}|) = (1, 1)$.

A symmetrizable generalized Cartan matrix C is **connected** if $\Gamma(C)$ is a connected graph. If D is a minimal symmetrizer of C , then the other symmetrizers of C are given by mD with $m \geq 1$.

Given (C, D) as above, let $q_{C,D}: \mathbb{Z}^n \rightarrow \mathbb{Z}$ be the quadratic form defined by

$$q_{C,D} := \sum_{i=1}^n c_i X_i^2 - \sum_{i < j} c_i |c_{ij}| X_i X_j.$$

For $1 \leq i \leq n$ let H_i be a finite-dimensional K -skew field, and for each edge

$$i \xrightarrow{(|c_{ji}|, |c_{ij}|)} j$$

of $\Gamma(C)$ let ${}_i H_j$ be an H_i - H_j -bimodule and let ${}_j H_i$ be an H_j - H_i -bimodule such that K acts centrally and the following hold:

- (i) $\dim_K(H_i) = c_i$ for all i , and $\dim_K({}_i H_j) = \dim_K({}_j H_i) = c_i |c_{ij}|$.
- (ii) There are isomorphisms

$${}_j H_i \cong \text{Hom}_{H_i}({}_i H_j, H_i) \cong \text{Hom}_{H_j}({}_i H_j, H_j)$$

of H_j - H_i -bimodules.

The tuple $\mathcal{M}(C, D) := (H_i, {}_i H_j, {}_j H_i)$ is called a **modulation** or **species** for (C, D) .

In particular, we have

$${}_{H_i}({}_i H_j) \cong H_i^{|c_{ij}|} \cong ({}_j H_i)_{H_i} \quad \text{and} \quad {}_{H_j}({}_j H_i) \cong H_j^{|c_{ji}|} \cong ({}_i H_j)_{H_j}.$$

Let $C = (c_{ij}) \in M_n(\mathbb{Z})$ be a symmetrizable generalized Cartan matrix. An **orientation of C** is a subset $\Omega \subset \{1, 2, \dots, n\} \times \{1, 2, \dots, n\}$ such that the following hold:

- (i) $\{(i, j), (j, i)\} \cap \Omega \neq \emptyset$ if and only if $c_{ij} < 0$;
- (ii) For each sequence $((i_1, i_2), (i_2, i_3), \dots, (i_t, i_{t+1}))$ with $t \geq 1$ and $(i_s, i_{s+1}) \in \Omega$ for all $1 \leq s \leq t$ we have $i_1 \neq i_{t+1}$.

(We think of $(i, j) \in \Omega$ as an arrow $i \longleftarrow j$. Condition (ii) says that there are no oriented cycles.)

For an orientation Ω of C , a **representation** $M = (M_i, M_{ij})$ of $(\mathcal{M}(C, D), \Omega)$ is given by a finite-dimensional H_i -module M_i for each $1 \leq i \leq n$ and an H_i -linear map

$$M_{ij}: {}_iH_j \otimes_j M_j \rightarrow M_i$$

for each $(i, j) \in \Omega$.

A **morphism** $f: M \rightarrow N$ of representations $M = (M_i, M_{ij})$ and $N = (N_i, N_{ij})$ of $(\mathcal{M}(C, D), \Omega)$ is a tuple $f = (f_i)_i$ of H_i -linear maps $f_i: M_i \rightarrow N_i$ for $1 \leq i \leq n$ such that for each $(i, j) \in \Omega$ the diagram

$$\begin{array}{ccc} {}_iH_j \otimes_j M_j & \xrightarrow{1 \otimes_j f_j} & {}_iH_j \otimes_j N_j \\ \downarrow M_{ij} & & \downarrow N_{ij} \\ M_i & \xrightarrow{f_i} & N_i \end{array}$$

commutes.

The representations of $(\mathcal{M}(C, D), \Omega)$ form an abelian category which is denoted by $\text{rep}(C, D, \Omega)$.

To define $\text{rep}(C, D, \Omega)$, one only needs the bimodules ${}_iH_j$ for $(i, j) \in \Omega$. To define reflection functors which relate these categories for different orientations one also needs the bimodules ${}_jH_i$ and condition (ii) in the definition of a modulation.

Let S be a K -algebra, and let $B = {}_A B_A$ be an A - A -bimodule. The **tensor algebra** $T_S(B)$ is defined as

$$T_S(B) := \bigoplus_{m \geq 0} B^{\otimes m}$$

where $B^0 := S$, and $B^{\otimes m} := B \otimes_S \cdots \otimes_S B$ is the m -fold tensor product of B for $m \geq 1$.

Recall that the multiplication of $T_S(B)$ is defined as follows: For $r, s \geq 1$, $b_i, b'_i \in B$ and $a, a' \in S$ let

$$(b_1 \otimes \cdots \otimes b_r) \cdot (b'_1 \otimes \cdots \otimes b'_s) := (b_1 \otimes \cdots \otimes b_r \otimes b'_1 \otimes \cdots \otimes b'_s)$$

and

$$a(b_1 \otimes \cdots \otimes b_r)a' := (ab_1 \otimes \cdots \otimes b_r a').$$

Obviously, $T_S(B)$ is generated by S and B as a K -algebra.

Proposition 3.15. *The $T_S(B)$ -modules are given by the S -module homomorphisms $B \otimes_S X \rightarrow X$, where X is an S -module.*

For a modulation $(H_i, {}_iH_j, {}_jH_i)$ for (C, D) and an orientation Ω of C let

$$S := \prod_{i=1}^n H_i \quad \text{and} \quad B := \bigoplus_{(i,j) \in \Omega} {}_iH_j.$$

Then B is an S - S -bimodule in the obvious way. The tensor algebra $T_S(B)$ is sometimes called a **species** or **species algebra** of type C .

Theorem 3.16. *The following hold:*

- (i) $T_S(B)$ is a finite-dimensional hereditary K -algebra whose Tits form coincides with $q_{C,D}$.
- (ii) There is an equivalence

$$\begin{aligned} \text{rep}(\mathcal{M}(C, D), \Omega) &\rightarrow \text{mod}(T_S(B)) \\ (M_i, M_{ij}) &\mapsto M := \bigoplus_{i=1}^n M_i. \end{aligned}$$

Here $T_S(B)$ acts on M as follows: The action of S on M is clear. For $a_{ij} \in {}_iH_j$ and $m_j \in M_j$ let $a_{ij}m_j := M_{ij}({}_i a_j \otimes m_j)$.

Examples:

- (i) Let Q be an acyclic quiver with $Q_0 = \{1, \dots, n\}$, and let $A = KQ$ be its path algebra. Let $\Omega := \{(t(a), s(a)) \mid a \in Q_1\}$. For $i \in Q_0$ set $H_i := K$, and for $(i, j) \in \Omega$ let ${}_iH_j$ be the subspace of KQ spanned by the arrows $\{a \in Q_1 \mid s(a) = j \text{ and } t(a) = i\}$, and let ${}_jH_i := D({}_iH_j)$ be the K -dual of ${}_iH_j$. Then $(H_i, {}_iH_j, {}_jH_i)$ is a modulation for (C, D) where $C = (c_{ij})$ is defined by

$$c_{ij} := \begin{cases} 2 & \text{if } i = j, \\ -|\{a \in Q_1 \mid \{s(a), t(a)\} = \{i, j\}\}| & \text{otherwise,} \end{cases}$$

and $D := (1, \dots, 1)$. Let

$$S := \prod_{i \in Q_0} H_i \quad \text{and} \quad B := \bigoplus_{(i,j) \in \Omega} {}_iH_j.$$

There is a K -algebra isomorphism

$$KQ \rightarrow T_S(B)$$

which is defined in the obvious way. Thus all finite-dimensional path algebras are isomorphic to species.

- (ii) The complex numbers \mathbb{C} are an \mathbb{R} - \mathbb{C} -bimodule ${}_{\mathbb{R}}\mathbb{C}_{\mathbb{C}}$ in the obvious way. Let $S := \mathbb{R} \times \mathbb{C}$ and $B := {}_{\mathbb{R}}\mathbb{C}_{\mathbb{C}}$. Then there is a K -algebra isomorphism

$$T_S(B) \rightarrow \begin{pmatrix} \mathbb{R} & \mathbb{C} \\ 0 & \mathbb{C} \end{pmatrix}.$$

This is a representation-finite 5-dimensional \mathbb{R} -algebra of Dynkin type B_2 .

LITERATURE – SPECIES ALGEBRAS

- [BB76] S. Brenner, M. Butler, *The equivalence of certain functors occurring in the representation theory of Artin algebras and species*. J. London Math. Soc. (2) 14 (1976), no. 1, 183–187.
- [DR75] V. Dlab, C.M. Ringel, *On algebras of finite representation type*. J. Algebra 33 (1975), 306–394.
- [DR76] V. Dlab, C.M. Ringel, *Indecomposable representations of graphs and algebras*. Mem. Amer. Math. Soc. 6 (1976), no. 173, v+57 pp.
- [DR79] V. Dlab, C.M. Ringel, *A module theoretical interpretation of properties of the root system*. Ring theory (Proc. Antwerp Conf. (NATO Adv. Study Inst.), Univ. Antwerp, Antwerp, 1978), pp. 435–451, Lecture Notes in Pure and Appl. Math., 51, Dekker, New York, 1979.
- [DR80] V. Dlab, C.M. Ringel, *The preprojective algebra of a modulated graph*. Representation theory, II (Proc. Second Internat. Conf., Carleton Univ., Ottawa, Ont., 1979), pp. 216–231, Lecture Notes in Math., 832, Springer, Berlin-New York, 1980.
- [G73] P. Gabriel, *Indecomposable representations. II*. Symposia Mathematica, Vol. XI (Convegno di Algebra Commutativa, INDAM, Rome, 1971), pp. 81–104. Academic Press, London, 1973.
- [GLS17] C. Geiß, B. Leclerc, J. Schröer, *Quivers with relations for symmetrizable Cartan matrices I: Foundations*. Invent. Math. 209 (2017), no. 1, 61–158.
- [GLS20] C. Geiß, B. Leclerc, J. Schröer, *Rigid modules and Schur roots*. Math. Z. 295 (2020), no. 3–4, 1245–1277.
- [K17] J. Külshammer, *Pro-species of algebras I: Basic properties*. Algebr. Represent. Theory 20 (2017), no. 5, 1215–1238.
- [R76] C.M. Ringel, *Representations of K -species and bimodules*. J. Algebra 41 (1976), no. 2, 269–302.

[Back to Overview Hereditary 3.](#)

3.4. Preprojective algebras. Let $Q = (Q_0, Q_1, s, t)$ be an acyclic connected quiver. Let \overline{Q} be the **double quiver** obtained from Q by adding for each arrow $a: i \rightarrow j$ in Q a new arrow $a^*: j \rightarrow i$ pointing in the opposite direction.

The **preprojective algebra** associated with Q is

$$\Pi(Q) := K\overline{Q}/(c)$$

where (c) is the ideal generated by

$$c := \sum_{a \in Q_1} (aa^* - a^*a).$$

Example: Let Q be the quiver

$$1 \xleftarrow{a} 2 \xleftarrow{b} 3 \xrightarrow{c} 4$$

The AR quiver Γ_{KQ} looks as follows:

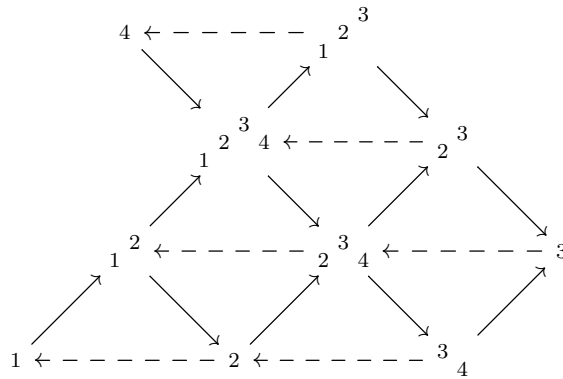

Then

$$\Pi(Q) = K\bar{Q}/I$$

where \bar{Q} is the quiver

$$1 \begin{matrix} \xleftarrow{a} \\ \xrightarrow{a^*} \end{matrix} 2 \begin{matrix} \xleftarrow{b} \\ \xrightarrow{b^*} \end{matrix} 3 \begin{matrix} \xleftarrow{c} \\ \xrightarrow{c^*} \end{matrix} 4$$

and I is generated by

$$\{aa^*, bb^* - a^*a, -c^*c - b^*b, cc^*\}$$

The indecomposable projective $\Pi(Q)$ -modules are

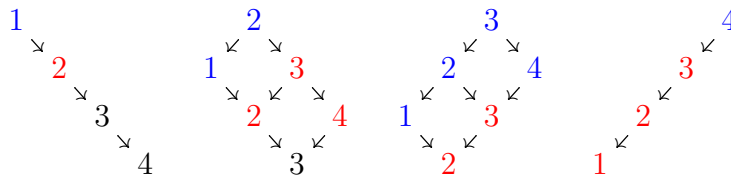

Observe how the colours are related to the τ -orbits in Γ_{KQ} .

Preprojective algebras appear in many different contexts and provide several beautiful bridges to other areas of mathematics (e.g. representation theory of Kac-Moody Lie algebras, cluster algebras and singularity theory).

For an algebra A and an A - A -bimodule B let

$$T_A(B) := \bigoplus_{m \geq 0} B^{\otimes m}$$

be the associated tensor algebra. Note that $\text{Ext}_{KQ}^1(D(KQ), KQ)$ is an KQ - KQ -bimodule in the obvious way.

Theorem 3.17. $\Pi(Q) \cong T_{KQ}(\text{Ext}_{KQ}^1(D(KQ), KQ))$.

Corollary 3.18. *We have*

$${}_{KQ}\Pi(Q) \cong \bigoplus_X X$$

where the direct sum runs over a complete set of representatives of isomorphism classes of indecomposable preprojective KQ -modules.

Corollary 3.18 justifies the name *preprojective algebra* for $\Pi(Q)$.

Theorem 3.19. *Let $\Pi = \Pi(Q)$. For $X, Y \in \text{mod}(\Pi)$ there is a functorial isomorphism*

$$\text{Ext}_{\Pi}^1(X, Y) \cong D \text{Ext}_{\Pi}^1(Y, X).$$

Theorem 3.20. *The following are equivalent:*

- (i) Q is a Dynkin quiver;
- (ii) $\Pi(Q)$ is finite-dimensional.

In this case, $\Pi(Q)$ is selfinjective. If Q is not a Dynkin quiver, then $\text{gl. dim}(\Pi(Q)) = 2$.

The preprojective algebra $\Pi(Q)$ is representation-finite if and only if Q is of type A_n with $n = 1, 2, 3, 4$, and $\Pi(Q)$ is tame if and only if Q is of type A_5 or D_4 .

3.4.1. *Nilpotent varieties. To be continued...*

3.4.2. *Semicanonical and dual semicanonical bases. To be continued...*

3.4.3. *Preprojective algebras and cluster algebras. To be continued...*

LITERATURE – PREPROJECTIVE ALGEBRAS

To be updated and expanded...

- [BGL87] D. Baer, W. Geigle, H. Lenzing, *The preprojective algebra of a tame hereditary Artin algebra*. *Comm. Algebra* 15 (1987), no. 1-2, 425–457.
- [BK12] P. Baumann, J. Kamnitzer, *Preprojective algebras and MV polytopes*. *Represent. Theory* 16 (2012), 152–188.
- [BKT14] P. Baumann, J. Kamnitzer, P. Tingley, *Affine Mirković-Vilonen polytopes*. *Publ. Math. Inst. Hautes Études Sci.* 120 (2014), 113–205.
- [CB01] W. Crawley-Boevey, *Geometry of the moment map for representations of quivers*. *Compositio Math.* 126 (2001), 257–293.
- [CBH98] W. Crawley-Boevey, M.P. Holland, *Noncommutative deformations of Kleinian singularities*. *Duke Math. J.* 92 (1998), 605–635.
- [DR80] V. Dlab, C.M. Ringel, *The preprojective algebra of a modulated graph*. *Representation theory, II (Proc. Second Internat. Conf., Carleton Univ., Ottawa, Ont., 1979)*, pp. 216–231, *Lecture Notes in Math.*, 832, Springer, Berlin-New York, 1980.

- [GLS05] C. Geiß, B. Leclerc, J. Schröer, *Semicanonical bases and preprojective algebras*. Ann. Sci. École Norm. Sup. (4) 38 (2005), no. 2, 193–253.
- [GLS06a] C. Geiß, B. Leclerc, J. Schröer, *Rigid modules over preprojective algebras*. Invent. Math. 165 (2006), no. 3, 589–632.
- [GLS06b] C. Geiss, B. Leclerc, J. Schröer, *Verma modules and preprojective algebras*. Nagoya Math. J. 182 (2006), 241–258.
- [Lu90] G. Lusztig, *Canonical bases arising from quantized enveloping algebras*. J. Amer. Math. Soc. 3 (1990), no. 2, 447–498.
- [Lu91] G. Lusztig, *Canonical bases arising from quantized enveloping algebras. II*. Common trends in mathematics and quantum field theories (Kyoto, 1990). Progr. Theoret. Phys. Suppl. No. 102 (1990), 175–201 (1991).
- [Lu92] G. Lusztig, *Affine quivers and canonical bases*. Inst. Hautes Études Sci. Publ. Math. No. 76 (1992), 111–163.
- [Lu00] G. Lusztig, *Semicanonical bases arising from enveloping algebras*. Adv. Math. 151 (2000), no. 2, 129–139.
- [N98] H. Nakajima, *Quiver varieties and Kac-Moody algebras*. Duke Math. J. 91 (1998), no. 3, 515–560.
- [R98] C.M. Ringel, *The preprojective algebra of a quiver*. Algebras and modules, II (Geiranger, 1996), 467–480, CMS Conf. Proc., 24, Amer. Math. Soc., Providence, RI, 1998.

Back to Overview Hereditary [3](#).

3.5. Quasi-hereditary algebras. Let A be a finite-dimensional K -algebra. Let $S(1), \dots, S(n)$ be the simple A -modules, and let $P(1), \dots, P(n)$ (resp. $I(1), \dots, I(n)$) be the indecomposable projective (resp. indecomposable injective) A -modules, up to isomorphism. We label these modules such that

$$\text{top}(P(i)) \cong S(i) \cong \text{soc}(I(i)).$$

3.5.1. Standard modules.

Let $\Delta(i)$ be the largest factor module of $P(i)$ such that $[\Delta(i) : S(j)] = 0$ for all $j > i$. The modules $\Delta(i)$ are called **standard modules** of A .

From this definition we immediately get the following:

- (i) $\text{top}(\Delta(i)) \cong S(i)$.
- (ii) $\Delta(i)$ is indecomposable.
- (iii) $\Delta(n) = P(n)$.

Let $\mathcal{F}(\Delta)$ be the full subcategory of all $X \in \text{mod}(A)$ having a filtration

$$0 = X_0 \subset X_1 \subset \cdots \subset X_t = X$$

such that for each $1 \leq i \leq t$ we have $X_i/X_{i-1} \cong \Delta(j)$ for some $1 \leq j \leq n$. Such a filtration is called a **Δ -filtration** of X . We additionally assume that $0 \in \mathcal{F}(\Delta)$.

Lemma 3.21. *For $1 \leq i \leq j \leq n$ we have $\text{Ext}_A^1(\Delta(j), \Delta(i)) = 0$.*

3.5.2. Quasi-hereditary algebras.

The algebra A is a **standardly stratified algebra** if for each $1 \leq i \leq n$ we have

$$P(i) \in \mathcal{F}(\Delta).$$

The algebra A is **quasi-hereditary** if for each $1 \leq i \leq n$ the following hold:

- (i) $P(i) \in \mathcal{F}(\Delta)$.
- (ii) $[\Delta(i) : S(i)] = 1$.

Proposition 3.22 ([ADL98]). *The following are equivalent:*

- (i) A is quasi-hereditary.
- (ii) A is standardly stratified and $\text{gl. dim}(A) < \infty$.

Note that the definition of $\Delta(i)$ depends on the labeling of the simple A -modules. Thus A might be quasi-hereditary for one labeling and not quasi-hereditary for another.

There is an equivalent definition of quasi-hereditary algebras using *hereditary chains*, see [CPS88, DR89].

One can use *adapted partial orders* on the simple A -modules instead of total orders to define quasi-hereditary algebras. For simplicity we restricted to the case of total orders.

Quasi-hereditary algebras were introduced by Cline, Parshall and Scott [CPS88]. They appear in different interesting contexts. Most notably, each block of the BGG category \mathcal{O} of a reductive Lie algebra over \mathbb{C} is Morita equivalent to $\text{mod}(A)$ for some quasi-hereditary \mathbb{C} -algebra A .

Examples: In the following examples we highlight the standard modules $\Delta(i)$ with different colours.

(i) Let Q be the quiver

$$1 \begin{array}{c} \xrightarrow{a} \\ \xleftarrow{b} \end{array} 2$$

and let $A = KQ/I$ with I generated by ab . The indecomposable projective A -modules are

$$P(1) = \begin{array}{c} 1 \\ 2 \\ 1 \end{array} \quad P(2) = \begin{array}{c} 2 \\ 1 \end{array}.$$

(Both $P(1)$ and $P(2)$ are uniserial modules. The numbers 1 and 2 stand for composition factors isomorphic to the simple A -modules $S(1)$ and $S(2)$, respectively.) The standard modules are

$$\Delta(1) \cong S(1) = \begin{array}{c} 1 \end{array} \quad \text{and} \quad \Delta(2) = P(2) = \begin{array}{c} 2 \\ 1 \end{array}.$$

Now it is obvious that A is quasi-hereditary.

(ii) Let Q be the quiver

$$1 \xrightarrow{a} 2 \xrightarrow{b} 3$$

and let $A = KQ/I$ with I generated by ba . The indecomposable projective A -modules are

$$P(1) = \begin{array}{c} 1 \\ 2 \end{array} \quad P(2) = \begin{array}{c} 2 \\ 3 \end{array} \quad P(3) = \begin{array}{c} 3 \end{array}.$$

Thus A is quasi-hereditary with standard modules $\Delta(i) \cong S(i)$ for $i = 1, 2, 3$. Using the labeling

$$3 \xrightarrow{a} 2 \xrightarrow{b} 1$$

A is quasi-hereditary with standard modules $\Delta(i) = P(i)$ for $i = 1, 2, 3$.

$$P(1) = \begin{array}{c} 1 \end{array} \quad P(2) = \begin{array}{c} 2 \\ 1 \end{array} \quad P(3) = \begin{array}{c} 3 \\ 2 \end{array}.$$

However, for the labeling

$$1 \xrightarrow{a} 3 \xrightarrow{b} 2$$

A is no longer quasi-hereditary, since $P(1)$ does not have a Δ -filtration.

$$P(1) = \begin{array}{c} 1 \\ 3 \end{array} \quad P(2) = \begin{array}{c} 2 \end{array} \quad P(3) = \begin{array}{c} 3 \\ 2 \end{array}.$$

- (iii) Let $A = KQ/I$ be a basic algebra such that Q has no oriented cycles. Then there exists a labeling of the simple A -modules such that A becomes quasi-hereditary with $\Delta(i) \cong S(i)$ (resp. $\Delta(i) = P(i)$) for all i .
- (iv) The following example is due to Dlab and Ringel [DR89]. Let Q be the quiver

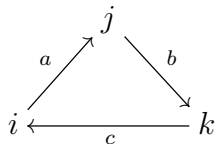

and let $A = KQ/I$ with I generated by $\{bac, acba\}$. We have $\text{gl. dim}(A) = 4$.

$$P(i) = \begin{array}{c} i \\ j \\ k \\ i \end{array} \quad P(j) = \begin{array}{c} j \\ k \\ i \\ j \end{array} \quad P(k) = \begin{array}{c} k \\ i \\ j \end{array}$$

There does not exist a labeling such that A becomes quasi-hereditary.

- (v) Let Q be the quiver



and let $A = KQ/I$ with I generated by a^2 . We have

$$P(1) = \Delta(1) = \begin{array}{c} 1 \\ 1 \end{array}$$

So $P(1) \in \mathcal{F}(\Delta)$. Thus A is standardly stratified. However A is not quasi-hereditary since $[\Delta(1) : S(1)] = 2 > 1$.

The following two theorems deal with the question of finding quasi-hereditary labelings. We omit the proofs.

Theorem 3.23 (Dlab, Ringel [DR89, Theorem 1]). *The following are equivalent:*

- (i) A is quasi-hereditary for each labeling of the simple A -modules.
- (ii) A is hereditary.

Theorem 3.24 (Dlab, Ringel [DR89, Theorem 2]). *If $\text{gl. dim}(A) \leq 2$, then there exists a labeling of the simple A -modules such that A becomes quasi-hereditary.*

Theorem 3.25 (Cline, Parshall, Scott [CPS88]). *Let A be quasi-hereditary. Then*

$$\text{gl. dim}(A) < \infty.$$

Dually, let $\nabla(i)$ be the largest submodule of $I(i)$ such that $[\nabla(i) : S(j)] = 0$ for all $j > i$. The modules ∇_i are called **costandard modules**.

Similarly as above, let $\mathcal{F}(\nabla)$ be the full subcategory of $\text{mod}(A)$ consisting of A -modules having a filtration by costandard modules.

Theorem 3.26 (Dlab, Ringel [DR92, Proposition 3.1]). *Let A be quasi-hereditary. There is a tilting module $T \in \text{mod}(A)$ such that*

$$\mathcal{F}(\Delta) \cap \mathcal{F}(\nabla) = \text{add}(T).$$

The module T appearing in the previous theorem is the **characteristic tilting module** of A . The algebra

$$B := \text{End}_A(T)^{\text{op}}$$

is called the **Ringel dual** of A .

Let T be the characteristic module of a quasi-hereditary algebra A . Then

$$\mathcal{F}(\Delta) = \{X \in \text{mod}(A) \mid \text{Ext}_A^i(X, T) = 0 \text{ for all } i \geq 1\}$$

and

$$\mathcal{F}(\nabla) = \{Y \in \text{mod}(A) \mid \text{Ext}_A^i(T, Y) = 0 \text{ for all } i \geq 1\}.$$

A quasi-hereditary algebra A is **strongly quasi-hereditary** if

$$\text{proj. dim}(\Delta(i)) \leq 1$$

for all $1 \leq i \leq n$.

Theorem 3.27 (Iyama [I03]). *Let $X \in \text{mod}(A)$. Then there exists some $Y \in \text{mod}(A)$ such that*

$$\text{End}_A(X \oplus Y)^{\text{op}}$$

is a strongly quasi-hereditary algebra.

Ringel [R10] wrote Iyama's proof of Theorem 3.27 in a more transparent way and also noted that the resulting algebras are strongly quasi-hereditary and not just quasi-hereditary.

Corollary 3.28 (Iyama [I03]). $\text{rep. dim}(A) < \infty$.

Proof. Let $X := {}_A A \oplus D(A_A)$ and then apply Theorem 3.27. □

Corollary 3.29. *Auslander algebras are strongly quasi-hereditary.*

Corollary 3.30. *Let A be a finite-dimensional K -algebra. Then there is a strongly quasi-hereditary K -algebra Γ and an idempotent $e \in \Gamma$ with*

$$e\Gamma e \cong A.$$

Following closely Ringel [R10], we outline a constructive proof of Theorem 3.27.

Let $X, Y \in \text{mod}(A)$, and let

$$X = \bigoplus_{i=1}^r X_i \quad \text{and} \quad Y = \bigoplus_{j=1}^s Y_j$$

be in $\text{mod}(A)$ with X_i and Y_j indecomposable for all i and j . Let $u_i: X_i \rightarrow X$ be the canonical inclusion, and let $p_j: Y \rightarrow Y_j$ the canonical projection. Let $\text{rad}_A(X, Y)$ be the set of all $f \in \text{Hom}_A(X, Y)$ such that

$$p_j f u_i: X_i \rightarrow Y_j$$

is non-invertible for all i and j .

Lemma 3.31. *The following hold:*

- (i) $\text{rad}_A(X, Y)$ is a subspace of $\text{Hom}_A(X, Y)$.
- (ii) $\text{rad}_A(X, Y)$ does not depend on the chosen direct sum decompositions of X and Y .

For $X \in \text{mod}(A)$, the subspace $\text{rad}_A(X, X)$ is just the radical of the K -algebra $\text{End}_A(X)$. Recall that we can see X as an $\text{End}_A(X)$ -module. Then

$$\gamma X := \text{rad}_A(X, X)X$$

is the radical of the $\text{End}_A(X)$ -module X . To make this explicit, we have

$$\gamma X = \sum_{f \in \text{rad}_A(X, X)} \text{Im}(f).$$

Obviously, γX is also an A -submodule of the A -module X .

Lemma 3.32. *For $X \in \text{mod}(A)$ the following hold:*

- (i) *If X is non-zero, then γX is a proper submodule of X .*

(ii) For each direct sum decomposition $X = X_1 \oplus \cdots \oplus X_m$ we have

$$\gamma X = \bigoplus_{i=1}^m (X_i \cap \gamma X)$$

and

$$X_i \cap \gamma X = \text{rad}_A(X, X_i)X := \sum_{f \in \text{rad}_A(X, X_i)} \text{Im}(f).$$

Now we come to the key construction. We consider a fixed $X \in \text{mod}(A)$. We define inductively

$$M_1 := X \quad \text{and} \quad M_{i+1} := \gamma M_i$$

for $i \geq 1$. By Lemma 3.32(i) there is some $n \geq 0$ such that $M_{n+1} = 0$. The smallest such n will be denoted by $d(X)$. We have $d(X) \leq \text{length}(X)$. Let

$$M := \bigoplus_{i=1}^{d(X)} M_i \quad \text{and} \quad M_{>i} := \bigoplus_{j=i+1}^{d(X)} M_j.$$

Given an indecomposable direct summand N of M , there is a unique index $i \geq 1$ such that N is isomorphic to a direct summand of M_i but not to a direct summand of $M_{>i}$. We call $\text{layer}(N) := i$ the **layer** of N .

The algebra

$$\Gamma := \text{End}_A(M)^{\text{op}} = \text{End}_A(X \oplus M_{>1})^{\text{op}}$$

is strongly quasi-hereditary.

The indecomposable projective Γ -modules are of the form

$$P(N) := \text{Hom}_A(M, N)$$

with N an indecomposable direct summand of M . By $S(N)$ we denote the (simple) top of the Γ -module $P(N)$. (All simple Γ -modules are of this form.)

Define

$$L(N) := \text{Hom}_A(M, N) / \langle M_{>i} \rangle.$$

where $\langle M_{>i} \rangle$ is the subspace of all homomorphisms $M \rightarrow N$ which factor through $\text{add}(M_{>i})$.

The following theorem almost immediately implies Theorem 3.27.

Theorem 3.33. *For each simple Γ -module $S(N)$ the following hold:*

- (i) $[L(N) : S(N')] = 0$ for all simples $S(N')$ with $\text{layer}(N') > \text{layer}(N)$.
- (ii) $[L(N) : S(N)] = 1$.

(iii) *The obvious projection*

$$\text{Hom}_A(M, N) \xrightarrow{f} L(N)$$

is a Γ -module epimorphism and $\text{layer}(S(N')) > \text{layer}(S(N))$ for all simples $S(N')$ with $[\text{top}(\text{Ker}(f)) : S(N')] \neq 0$.

(iv) $\text{Ker}(f)$ is projective.

Example: Let Q be the quiver

$$a \begin{array}{c} \curvearrowright \\ 1 \end{array} \xrightarrow{b} 2$$

and let $A = KQ/I$ where I is generated by a^2 . Let

$$X := {}_A A \oplus D(A_A) = P(1) \oplus P(2) \oplus I(1) \oplus I(2).$$

We can visualize X as follows:

$$\begin{array}{ccccccc} & & 1 & & & & 1 \\ & & \downarrow & & & & \downarrow \\ 1 & & 2 & \oplus & 2 & \oplus & 1 \\ & & \downarrow & & & & \downarrow \\ 2 & & & & & & 1 \\ & & & & & & \downarrow \\ & & & & & & 2 \end{array}$$

We have $d(X) = 4$, and the modules M_i and the layers look as follows:

$$\begin{array}{l} M_1 = \begin{array}{ccccccc} & & 1 & & & & 1 \\ & & \downarrow & & & & \downarrow \\ 1 & & 2 & \oplus & 2 & \oplus & 1 \\ & & \downarrow & & & & \downarrow \\ 2 & & & & & & 1 \end{array} \quad \text{Layer 1:} \quad N_1 = \begin{array}{cc} & 1 \\ 1 & 2 \end{array} \\ \\ M_2 = \begin{array}{ccccccc} & & & & & & 1 \\ & & & & & & \downarrow \\ 1 & & 2 & \oplus & 1 & \oplus & 1 \\ & & \downarrow & & & & \downarrow \\ 2 & & & & & & 1 \\ & & & & & & \downarrow \\ & & & & & & 2 \end{array} \quad \text{Layer 2:} \quad N_2 = \begin{array}{cc} & 1 \\ 1 & 2 \end{array} \\ \\ M_3 = \begin{array}{ccccccc} & & & & & & 1 \\ & & & & & & \downarrow \\ 2 & \oplus & 1 & \oplus & 1 & & \\ & & \downarrow & & & & \downarrow \\ & & 1 & \oplus & 2 & & \\ & & & & & & \downarrow \\ & & & & & & 1 \end{array} \quad \text{Layer 3:} \quad N_3 = \begin{array}{cc} 1 & \\ & 1 \end{array}, \quad N_4 = \begin{array}{cc} 1 & \\ & 2 \end{array} \\ \\ M_4 = \begin{array}{ccccccc} & & & & & & 1 \\ & & & & & & \downarrow \\ 1 & \oplus & 2 & & & & \\ & & \downarrow & & & & \downarrow \\ & & 2 & & & & \\ & & & & & & \downarrow \\ & & & & & & 2 \end{array} \quad \text{Layer 4:} \quad N_5 = \begin{array}{cc} 1 & \\ & 2 \end{array}, \quad N_6 = \begin{array}{cc} 1 & \\ & 2 \end{array} \end{array}$$

Let

$$\Gamma' := \text{End}_A(N_1 \oplus \dots \oplus N_6)^{\text{op}}.$$

Now Γ is Morita equivalent to Γ' , and Γ' is isomorphic to the path algebra of the quiver

$$\begin{array}{ccccc} 6 & \xleftarrow{a_1} & 1 & \xleftarrow{a_2} & 2 & \xleftarrow{a_3} & 3 \\ & & \uparrow & \downarrow & & \uparrow & \downarrow \\ & & a_5 & a_4 & & a_7 & a_6 \\ & & & & 4 & \xleftarrow{a_8} & 5 \end{array}$$

modulo the ideal generated by

$$\{a_4 a_5, a_1 a_2, a_5 a_4 a_2 a_3 a_7, a_1 a_5 a_8, a_6 a_7, a_2 a_3 a_7 - a_5 a_8, a_4 a_2 a_3 - a_8 a_6\}.$$

Theorem 3.34 ([G80]). *There is a K -algebra homomorphism*

$$\eta: \mathrm{GL}_n(K) \rightarrow S(n, r)$$

which induces an equivalence between $\mathrm{mod}(S(n, r))$ and the category of polynomial $\mathrm{GL}_n(K)$ -representation which are homogeneous of degree r .

The simple $S(n, r)$ -modules are indexed by integer tuples $\lambda = (\lambda_1, \dots, \lambda_n)$ with $\lambda_1 \geq \lambda_2 \geq \dots \geq \lambda_n \geq 0$ with $\lambda_1 + \dots + \lambda_n = r$.

Theorem 3.35 ([DN98]). *The following are equivalent:*

- (i) $S(n, r)$ is semisimple.
- (ii) One of the following holds:
 - $p = 0$ or $n = 1$;
 - $n \geq 2$ and $p > r$;
 - $p = 2$, $n = 2$, and $r = 3$.

Theorem 3.36 (Erdmann [E93]). *The following are equivalent:*

- (i) $S(n, r)$ is representation-finite.
- (ii) One of the following holds:
 - $p = 0$ or $n = 1$;
 - $n = 2$ and $r < p^2$;
 - $n \geq 3$ and $r < 2p$;
 - $p = 2$, $n = 2$ and $r = 5, 7$.

For representation-finite $S(n, r)$, Erdmann [E93] gives a description (up to Morita equivalence) of $S(n, r)$ in terms of quivers with relations.

Theorem 3.37 ([DEMN99]). *The following are equivalent:*

- (i) $S(n, r)$ is tame and not representation-finite.
- (ii) One of the following holds:
 - $p = 3$, $n = 3$ and $r = 7, 8$;
 - $p = 3$, $n = 2$ and $r = 9, 10, 11$;
 - $p = 2$, $n = 2$ and $r = 4, 9$.

Proposition 3.38 ([G80, Remark 6.5g]). *Let $n \geq r$. Then $S(n, r)$ is Morita equivalent to $S(r, r)$.*

Proposition 3.39 ([P89]). *$S(n, r)$ is quasi-hereditary.*

Example: This example is taken from [X92]. For $m \geq 1$ let $A_m := KQ/I$ where Q is the quiver

$$1 \begin{array}{c} \xleftarrow{a_1} \\ \xrightarrow{b_1} \end{array} 2 \begin{array}{c} \xleftarrow{a_2} \\ \xrightarrow{b_2} \end{array} \cdots \begin{array}{c} \xleftarrow{a_{m-1}} \\ \xrightarrow{b_{m-1}} \end{array} m$$

and I is generated by

$$\{a_1 b_1, a_i a_{i+1}, b_{i+1} b_i, b_j a_j - a_{j+1} b_{j+1} \mid 1 \leq i \leq m-2, 2 \leq j \leq m-1\}.$$

(For $m = 1$, we have $A_m = K$.) Let $n \geq r > 0$ and $p = r$. Then each block of $S(n, r)$ is Morita equivalent to some A_m , and there is exactly one block with $m \geq 2$.

LITERATURE – SCHUR ALGEBRAS

- [DEMN99] S. Doty, K. Erdmann, S. Martin, D. Nakano, *Representation type of Schur algebras*. Math. Z. 232 (1999), no. 1, 137–182.
- [DN98] S. Doty, D. Nakano, *Semisimplicity of Schur algebras*. Math. Camb. Phil. Soc. 124 (1998), 15–20.
- [E93] K. Erdmann, *Schur algebras of finite type*. Quart. J. Math. Oxford Ser. (2) 44 (1993), no. 173, 17–41.
- [E96] K. Erdmann, *Decomposition numbers for symmetric groups and composition factors of Weyl modules*. J. Algebra 180 (1996), no. 1, 316–320.
- [G80] J. Green, *Polynomial Representations of GL_n* . Lecture Notes in Mathematics, 830. Springer-Verlag, Berlin-New York, 1980. vi+118 pp.
- [M08] S. Martin, *Schur algebras and representation theory*. Reprint of the 1993 original. Cambridge Tracts in Mathematics, 112. Cambridge University Press, Cambridge, 2008. xvi+232 pp.
- [P89] B. Parshall, *Finite-dimensional algebras and algebraic groups*. Classical groups and related topics (Beijing, 1987), 97–114, Contemp. Math., 82, Amer. Math. Soc., Providence, RI, 1989.
- [X92] C. Xi, *The structure of Schur algebras $S_k(n, p)$ for $n \geq p$* . Canad. J. Math. 44 (1992), no. 3, 665–672.

Back to Overview Hereditary 3.

4. Tilted algebras

§4 Tilted algebras:

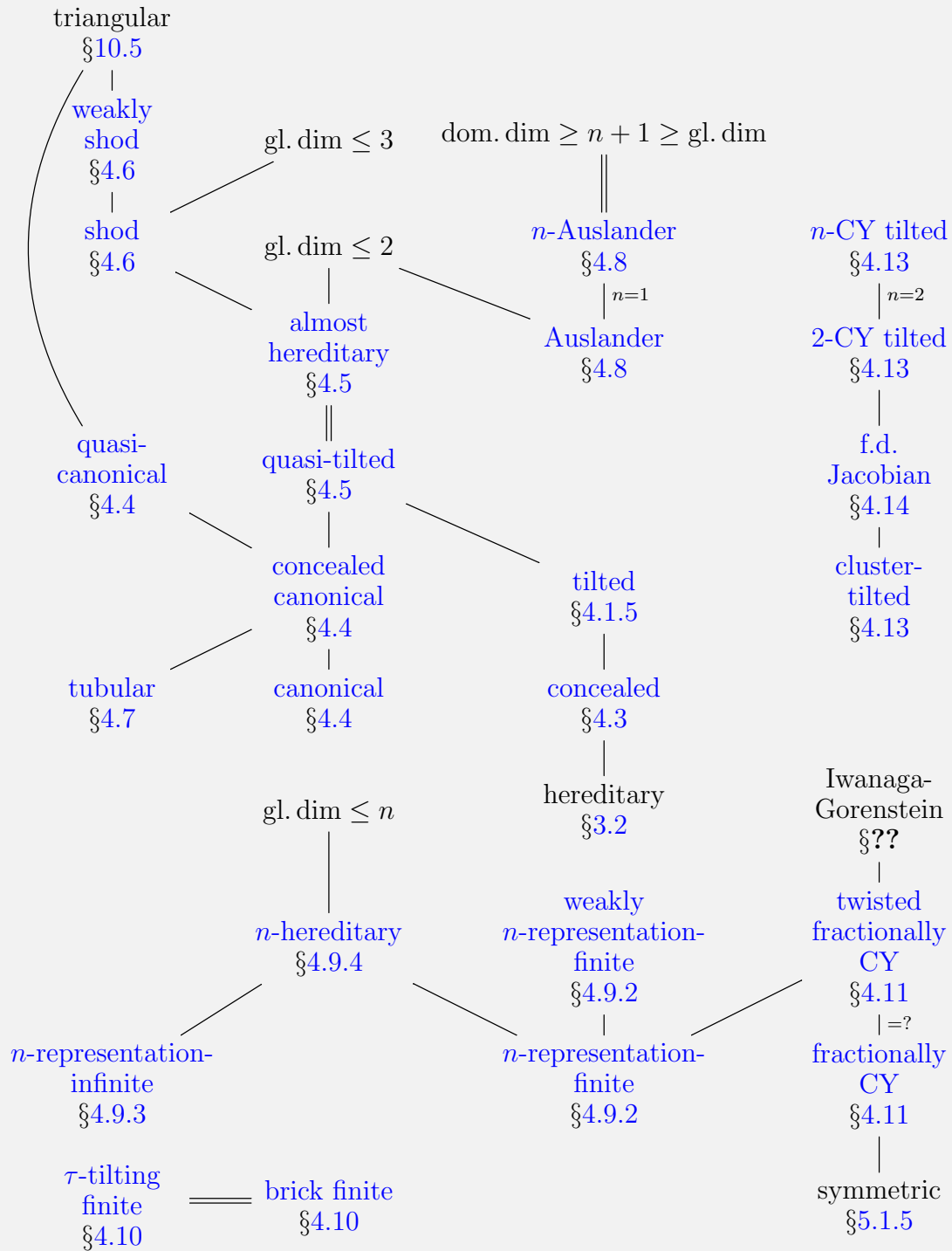

Back to Overview Metaclasses 1.

4.1. **Tilting theory.** Let A be a finite-dimensional K -algebra.

4.1.1. *Torsion pairs.*

Let \mathcal{F} and \mathcal{T} be full subcategories of $\text{mod}(A)$. Then $(\mathcal{T}, \mathcal{F})$ is called a **torsion pair** in $\text{mod}(A)$ provided the following hold:

- (i) For $Y \in \text{mod}(A)$ we have $\text{Hom}_A(\mathcal{T}, Y) = 0$ if and only if $Y \in \mathcal{F}$.
- (ii) For $X \in \text{mod}(A)$ we have $\text{Hom}_A(X, \mathcal{F}) = 0$ if and only if $X \in \mathcal{T}$.

In this case, \mathcal{T} is called the **torsion class** and \mathcal{F} is the **torsion-free class** of the torsion pair. If we deal with a fixed torsion pair $(\mathcal{T}, \mathcal{F})$, the modules in \mathcal{T} are **torsion modules** and the ones in \mathcal{F} are **torsion-free modules**.

4.1.2. *Tilting modules.*

$T \in \text{mod}(A)$ is a **tilting module** if the following hold:

- (i) $\text{Ext}_A^i(T, T) = 0$ for all $i \geq 1$.
- (ii) $\text{proj. dim}(T) = d < \infty$.
- (iii) There exists a short exact sequence

$$0 \rightarrow {}_A A \rightarrow T_0 \rightarrow T_1 \rightarrow \cdots \rightarrow T_d \rightarrow 0$$

where $T_i \in \text{add}(T)$ for all $0 \leq i \leq d$.

If $d \leq 1$, then such a module is also called a **classical tilting module**.

If A is hereditary, then each tilting module is automatically a classical tilting module.

There is also the dual concept of a **cotilting module**.

Warning: In the literature, classical tilting modules are often called *tilting modules*, and tilting modules are then called *generalized tilting modules*.

4.1.3. *Brenner-Butler Theorem.* Let $T \in \text{mod}(A)$ be a tilting module, and let $B := \text{End}_A(T)^{\text{op}}$. Then (A, T, B) is called a **tilting triple**.

Let (A, T, B) be a tilting triple with T a classical tilting module. Define

$$\begin{aligned} \mathcal{F}(T) &:= \{{}_A X \mid \text{Hom}_A(T, X) = 0\}, & \mathcal{X}(T) &:= \{{}_B Y \mid T \otimes_B Y = 0\}, \\ \mathcal{T}(T) &:= \{{}_A X \mid \text{Ext}_A^1(T, X) = 0\}, & \mathcal{Y}(T) &:= \{{}_B Y \mid \text{Tor}_1^B(T, Y) = 0\}. \end{aligned}$$

Then $(\mathcal{T}(T), \mathcal{F}(T))$ is a torsion pair in $\text{mod}(A)$, and $(\mathcal{X}(T), \mathcal{Y}(T))$ is a torsion pair in $\text{mod}(B)$.

Theorem 4.1 (Brenner, Butler [BB80, HR82]). *Let (A, T, B) be a tilting triple with T a classical tilting module. Then the functors*

$$\begin{aligned} \text{Hom}_A(T, -): \text{mod}(A) &\rightarrow \text{mod}(B), & \text{Ext}_A^1(T, -): \text{mod}(A) &\rightarrow \text{mod}(B), \\ T \otimes_B -: \text{mod}(B) &\rightarrow \text{mod}(A), & \text{Tor}_1^B(T, -): \text{mod}(B) &\rightarrow \text{mod}(A) \end{aligned}$$

restrict to equivalences

$$\begin{array}{ccc} \mathcal{T}(T) & \xrightarrow{\text{Hom}_A(T, -)} & \mathcal{Y}(T) \\ & \xleftarrow{T \otimes_B -} & \\ \mathcal{F}(T) & \xrightarrow{\text{Ext}_A^1(T, -)} & \mathcal{X}(T) \\ & \xleftarrow{\text{Tor}_1^B(T, -)} & \end{array}$$

which are quasi-inverses of each other.

Example: This example is due to Assem [A90]. Let Q be the quiver

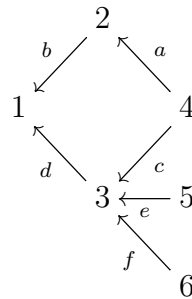

and let $A = KQ/I$ where the ideal I is generated by $\{ba - dc, de, df\}$. Here is the Auslander-Reiten Γ_A (we display the dimension vectors of the indecomposable modules):

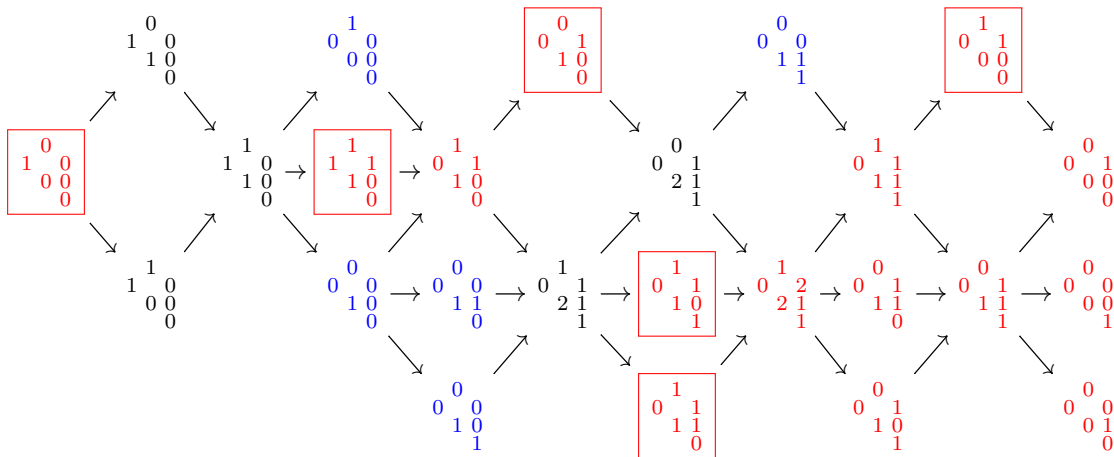

Let T be the direct sum of the six indecomposable A -modules which are framed in Γ_A . Thus

$$T := T(1) \oplus \cdots \oplus T(6) := \begin{matrix} 0 \\ 1 \\ 0 \\ 0 \end{matrix} \oplus \begin{matrix} 1 \\ 1 \\ 1 \\ 0 \end{matrix} \oplus \begin{matrix} 0 \\ 1 \\ 1 \\ 0 \end{matrix} \oplus \begin{matrix} 1 \\ 1 \\ 0 \\ 1 \end{matrix} \oplus \begin{matrix} 0 \\ 1 \\ 1 \\ 1 \end{matrix} \oplus \begin{matrix} 0 \\ 1 \\ 0 \\ 0 \end{matrix}.$$

quiver

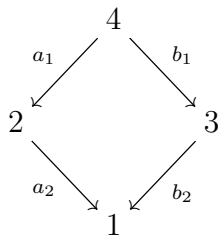

and I' is generated by $\{a_2a_1, b_2b_1\}$. The algebra B is representation-finite. (There are 10 indecomposable B -modules, up to isomorphism.)

4.1.4. *Reflection functors.* We now consider an important special case of the Brenner-Butler Theorem. (In fact, the Brenner-Butler Theorem (and tilting theory in general) were inspired by this special case.) Let Q be an acyclic quiver, and let $A = KQ$. Let $i \in Q_0$ be a sink, i.e. there is no arrow $a \in Q_1$ with $s(a) = i$. Let Q' be the quiver which is obtained from Q by reversing all arrows ending in i , and let $A' = KQ'$.



Then

$$T := \tau_A^{-1}(P(i)) \oplus {}_A A/P(i)$$

is a tilting module and

$$B := \text{End}_A(T)^{\text{op}} \cong A'.$$

(Note that $P(i) = S(i)$ is simple, since i is a sink.) We have

$$\mathcal{F}(T) = \text{add}(S(i)),$$

$$\mathcal{T}(T) = \{X \in \text{mod}(A) \mid X \text{ has no direct summand isomorphic to } S(i)\},$$

$$\mathcal{X}(T) = \text{add}(S(i)'),$$

$$\mathcal{Y}(T) = \{X \in \text{mod}(B) \mid X \text{ has no direct summand isomorphic to } S(i)'\}.$$

Here $S(i)'$ is the simple B -module which is isomorphic to the top of the indecomposable projective B -module $\text{Hom}_A(T, \tau_A^{-1}(P(i)))$. The functors

$$\text{Hom}_A(T, -): \text{mod}(A) \rightarrow \text{mod}(B) \quad \text{and} \quad \text{Ext}_A^1(T, -): \text{mod}(A) \rightarrow \text{mod}(B)$$

restrict to an equivalences

$$\text{Hom}_A(T, -): \mathcal{T}(T) \rightarrow \mathcal{Y}(T) \quad \text{and} \quad \text{Ext}_A^1(T, -): \mathcal{F}(T) \rightarrow \mathcal{X}(T).$$

The functor $\text{Hom}_A(T, -)$ is equivalent to the Bernstein-Gelfand-Ponomarev reflection functor

$$F_i^+ : \text{rep}(Q) \rightarrow \text{rep}(Q'),$$

i.e. there exists an equivalence $S: \text{rep}(Q') \rightarrow \text{mod}(B)$ such that the functors $S \circ F_i^+$ and $\text{Hom}_A(T, -)$ are isomorphic. (Here we identify $\text{mod}(A)$ and $\text{rep}(Q)$.) For more on this we refer to [APR79], [BB80], [BGP73].

4.1.5. *Tilted algebras.*

Let A be a finite-dimensional hereditary algebra, and let $T \in \text{mod}(A)$ be a tilting module. Then

$$B := \text{End}_A(T)^{\text{op}}$$

is called a **tilted algebra**.

The tilted algebra B is in general no longer hereditary, but we have $\text{gl. dim}(B) \leq 2$.

Theorem 4.2. *For a tilted algebra $B = \text{End}_A(T)^{\text{op}}$, each indecomposable B -module M is contained in $\mathcal{X}(T)$ or $\mathcal{Y}(T)$.*

A standard reference for tilted algebras is [HR82].

4.1.6. *Happel's and Rickard's theorem.*

Theorem 4.3 (Happel [H87a]). *Let (A, T, B) be a tilting triple. Then there exists a triangle equivalence*

$$\mathcal{D}^b(\text{mod}(A)) \rightarrow \mathcal{D}^b(\text{mod}(B)).$$

Happel stated his theorem for classical tilting modules, but his proof works for arbitrary tilting modules.

$T \in \mathcal{D}^b(\text{mod}(A))$ is a **tilting complex** if the following hold:

- (i) $\text{Hom}(T, T[i]) = 0$ for all $i \neq 0$.
- (ii) $\text{add}(T)$ generates $\mathcal{K}^b(\text{proj}(A))$ as a triangulated category.

Theorem 4.4 (Rickard [Ric89, Theorem 6.4]). *For finite-dimensional K -algebras A and B the following are equivalent:*

- (i) *There is a triangle equivalence*

$$\mathcal{D}^b(\text{mod}(A)) \rightarrow \mathcal{D}^b(\text{mod}(B)).$$

- (ii) *There is a triangle equivalence*

$$\mathcal{K}^b(\text{proj}(A)) \rightarrow \mathcal{K}^b(\text{proj}(B)).$$

- (iii) *There exists a tilting complex $T \in \mathcal{D}^b(\text{mod}(A))$ with*

$$B \cong \text{End}(T)^{\text{op}}.$$

LITERATURE – TILTING THEORY

- [A90] I. Assem, *Tilting theory – an introduction*. Topics in algebra, Part 1 (Warsaw, 1988), 127–180, Banach Center Publ., 26, Part 1, PWN, Warsaw, 1990.
- [APR79] M. Auslander, M. Platzeck, I. Reiten, *Coxeter functors without diagrams*. Trans. Amer. Math. Soc. 250 (1979), 1–46.
- [BGP73] I. Bernstein, I. Gelfand, V. Ponomarev, *Coxeter functors, and Gabriel’s theorem*. (Russian) Uspehi Mat. Nauk 28 (1973), no. 2(170), 19–33.
(Contains a conceptual proof of Gabriel’s Theorem. Invention of reflection functors and Coxeter functors for quivers.)
- [B81] K. Bongartz, *Tilted algebras*, Representations of algebras (Puebla, 1980), pp. 26–38, Lecture Notes in Math., 903, Springer, Berlin-New York, 1981.
- [BB80] S. Brenner, M. Butler, *Generalization of the Bernstein-Gelfand-Ponomarev reflection functors*. Representation theory, II (Proc. Second Internat. Conf., Carleton Univ., Ottawa, Ont., 1979), pp. 103–169, Lecture Notes in Math., 832, Springer, Berlin-New York, 1980.
(The birth of tilting theory.)
- [H87a] D. Happel, *Triangulated categories in the representation theory of finite-dimensional algebras*. London Mathematical Society Lecture Notes 119 (University Press, Cambridge, 1987)
- [H87b] D. Happel, *On the derived category of a finite-dimensional algebra*. Comment. Math. Helv. 62 (1987), no. 3, 339–389.
- [HR82] D. Happel, C.M. Ringel, *Tilted algebras*. Trans. Amer. Math. Soc. 274 (1982), 399–443.
(Standard reference for tilting theory and tilted algebras.)
- [M86] Y. Miyashita, *Tilting modules of finite projective dimension*. Math. Z. 193 (1986) 113–146.
- [Ric89] J. Rickard, *Morita theory for derived categories*. J. London Math. Soc. (2) 39 (1989), no. 3, 436–456.
- [R84] C.M. Ringel, *Tame algebras and integral quadratic forms*, Berlin [u.a.] : Springer, 1984, Lecture notes in mathematics; 1099

Back to Overview Tilted 4.

4.2. **τ -tilting theory.** Let A be a finite-dimensional algebra.

Tilting theory got revolutionized by cluster-tilting theory and τ -tilting theory, which were developed in the attempt to categorify Fomin-Zelevinsky cluster algebras.

$X \in \text{mod}(A)$ is **τ -rigid** if $\text{Hom}_A(X, \tau_A(X)) = 0$.

In this case, we have $\text{Ext}_A^1(X, X) = 0$.

Let $X \in \text{mod}(A)$ such that $\text{Ext}_A^1(X, X) = 0$ (i.e. X is **rigid**) and $\text{proj. dim}(X) \leq 1$. Then X is τ -rigid.

For $X \in \text{mod}(A)$ let $\text{sd}(X)$ be the number of isomorphism classes of indecomposable direct summands of X . Let $n(A) := \text{sd}({}_A A)$.

A τ -rigid module X is a **τ -tilting module** if $\text{sd}(X) = n(A)$.

Dually, one defines τ^- -rigid and τ^- -tilting modules.

For $X \in \text{mod}(A)$ let $\text{Ann}_A(X) := \{a \in A \mid aX = 0\}$.

Proposition 4.5 ([AIR14, Proposition 2.2]). *Let $X \in \text{mod}(A)$ be a τ -tilting module. Then X is a classical tilting module over $B := A/\text{Ann}_A(X)$.*

Theorem 4.6 ([AIR14, Theorem 0.2]). *Let $X \in \text{mod}(A)$ be τ -rigid. Then the following hold:*

- (i) $\text{sd}(X) \leq n(A)$.
- (ii) *There exists some $X' \in \text{mod}(A)$ such that $X \oplus X'$ is a τ -tilting module.*

Recall that $X \in \text{mod}(A)$ is **basic** if X is a direct sum of pairwise non-isomorphic indecomposable modules.

A pair (P, X) of A -modules is a **support τ -tilting pair** (resp. **almost complete support τ -tilting pair**) if the following hold:

- (i) X is τ -rigid;
- (ii) $P \in \text{proj}(A)$ and $\text{Hom}_A(P, X) = 0$;
- (iii) $\text{sd}(P) + \text{sd}(X) = n(A)$ (resp. $\text{sd}(P) + \text{sd}(X) = n(A) - 1$).

Such a pair is **basic** if P and X are basic.

We say that (P', X') is a **direct summand** of (P, X) if P' is a direct summand of P and X' is a direct summand of X .

Let $s\tau\text{-tilt}(A)$ be the set of isomorphism classes (in the obvious sense) of basic support τ -tilting pairs.

Dually, let $s\tau^-\text{-tilt}(A)$ be the set of isomorphism classes of basic support τ^- -tilting pairs.

Theorem 4.7 ([AIR14, Theorem 0.4]). *Any basic almost complete support τ -tilting pair of A -modules is a direct summand of exactly two basic support τ -tilting pairs.*

The **exchange graph** $E(s\tau\text{-tilt}(A))$ of basic support τ -tilting pairs has the elements from $s\tau\text{-tilt}(A)$ as vertices, and we draw an edge between two pairs if they share a basic almost complete support τ -tilting pair as a direct summand. Let $E(s\tau\text{-tilt}(A))^\circ$ be the connected component of $E(s\tau\text{-tilt}(A))$ which contains $(P(1) \oplus \cdots \oplus P(n), 0)$.

Examples:

(i) Let $A = KQ$ where Q is the quiver

$$1 \longleftarrow 2$$

The AR quivers Γ_A looks as follows:

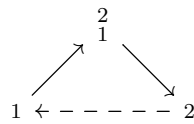

The indecomposable τ -rigids are

$$P(1) = 1, \quad P(2) = \begin{smallmatrix} 2 \\ 1 \end{smallmatrix}, \quad I(2) = 2.$$

Here is the exchange graph $E(s\tau\text{-tilt}(A))$ of basic support τ -tilting pairs:

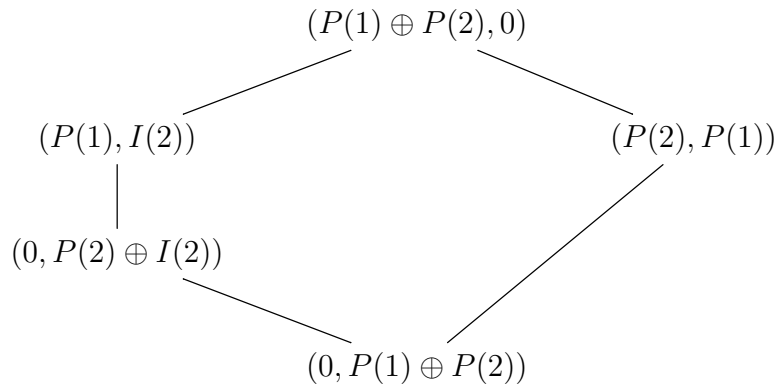

(ii) Let $A = KQ/I$ where Q is the quiver

$$a \begin{array}{c} \circlearrowleft \\ \longleftarrow \end{array} 1 \longleftarrow 2$$

and I is generated by a^2 . The AR quivers Γ_A looks as follows:

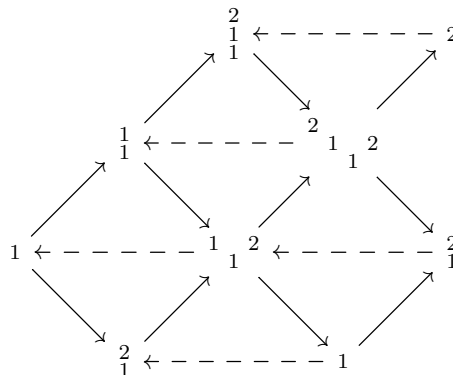

(One needs to identify the first module in the 3rd and 4th row with the last module in the 4th and 3rd row, respectively. So there are 7 indecomposables in total.) The indecomposable τ -rigids are

$$P(1) = \begin{smallmatrix} 1 \\ 1 \end{smallmatrix}, \quad P(2) = \begin{smallmatrix} 2 \\ 1 \end{smallmatrix}, \quad I(1) = \begin{smallmatrix} 2 & \\ & 1 \end{smallmatrix}, \quad I(2) = \begin{smallmatrix} 2 \end{smallmatrix}.$$

Here is the exchange graph $E(\text{s}\tau\text{-tilt}(A))$ of basic support τ -tilting pairs:

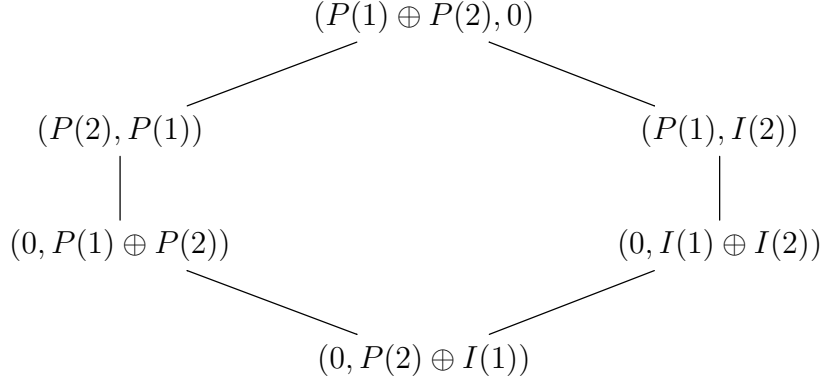

We work now over $K = \mathbb{C}$. Let Q be a 2-acyclic quiver, i.e. Q does not have loops or 2-cycles. Let $\mathcal{A}(Q)$ be the **Fomin-Zelevinsky cluster algebra** associated with Q . These are combinatorially defined (possibly infinitely generated) commutative \mathbb{C} -algebras.

Cluster algebras provide many bridges to other parts of mathematics. Survey articles on this are easy to find.

Theorem 4.8 (Derksen, Weyman, Zelevinsky [DWZ08, DWZ10]). *Let Q be a 2-acyclic quiver, and let S be a non-degenerate potential for Q . Assume that the Jacobian algebra $A = \mathcal{P}(Q, S)$ is finite-dimensional. Then there is an injective map*

$$\{\text{clusters in } \mathcal{A}(Q)\} \rightarrow \text{s}\tau\text{-tilt}(A)$$

which yields an isomorphism of exchange graphs

$$E(\mathcal{A}(Q)) \rightarrow E(\text{s}\tau\text{-tilt}(A))^\circ.$$

In the theorem above, the cluster variables which do not belong to the *initial cluster* $\{x_1, \dots, x_n\}$ in $\mathcal{A}(Q)$ correspond to the indecomposable τ -rigid A -modules.

The articles [DWZ08, DWZ10] contain a more general and differently worded version of the theorem above which does not need the finite-dimensionality assumption. There are also many analogous (and related) results which deal with cluster-tilting objects in 2-Calabi-Yau categories instead of support τ -tilting pairs for Jacobian algebras.

LITERATURE – τ -TILTING THEORY

- [AIR14] T. Adachi, O. Iyama, I. Reiten, τ -tilting theory. *Compos. Math.* 150 (2014), no. 3, 415–452.
- [DIJ19] L. Demonet, O. Iyama, G. Jasso, τ -tilting finite algebras, bricks, and g -vectors. *Int. Math. Res. Not. IMRN* 2019, no. 3, 852–892.
- [DWZ08] H. Derksen, J. Weyman, A. Zelevinsky, *Quivers with potentials and their representations. I. Mutations*. *Selecta Math. (N.S.)* 14 (2008), no. 1, 59–119.
- [DWZ10] H. Derksen, J. Weyman, A. Zelevinsky, *Quivers with potentials and their representations II: applications to cluster algebras*. *J. Amer. Math. Soc.* 23 (2010), no. 3, 749–790.
- [J15] G. Jasso, *Reduction of τ -tilting modules and torsion pairs*. *Int. Math. Res. Not. IMRN* 2015, no. 16, 7190–7237.

[Back to Overview Tilted 4.](#)

4.3. Concealed algebras. Let A be a finite-dimensional K -algebra.

A connected component \mathcal{C} of the Auslander-Reiten quiver Γ_A is a **preprojective component** if the following hold:

- (i) Each module in \mathcal{C} is isomorphic to $\tau_A^{-k}(P)$ for some indecomposable projective A -module P and some $k \geq 0$.
- (ii) \mathcal{C} does not have any oriented cycles.

The preprojective components of Γ_A can be computed via the knitting algorithm.

$T \in \text{mod}(A)$ is **preprojective** if each indecomposable direct summand of T lies in some preprojective component of Γ_A .

Indecomposable preprojective modules are directing modules. Thus, as a special case of [ARS97, Section IX, Theorem 1.2] they are determined by their dimension vectors:

Theorem 4.9. *Let $X, Y \in \text{mod}(A)$ be indecomposable with $\underline{\dim}(X) = \underline{\dim}(Y)$. If X is preprojective, then $X \cong Y$.*

Let A be hereditary, and let $T \in \text{mod}(A)$ be a preprojective tilting module. Then

$$B := \text{End}_A(T)^{\text{op}}$$

is a **concealed algebra**.

Concealed algebras form a special class of tilted algebras.

Example: Let $A = KQ$ where Q is the quiver

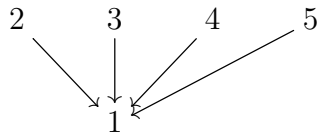

The preprojective component of Γ_A looks like this (we display the dimension vectors of the indecomposable modules):

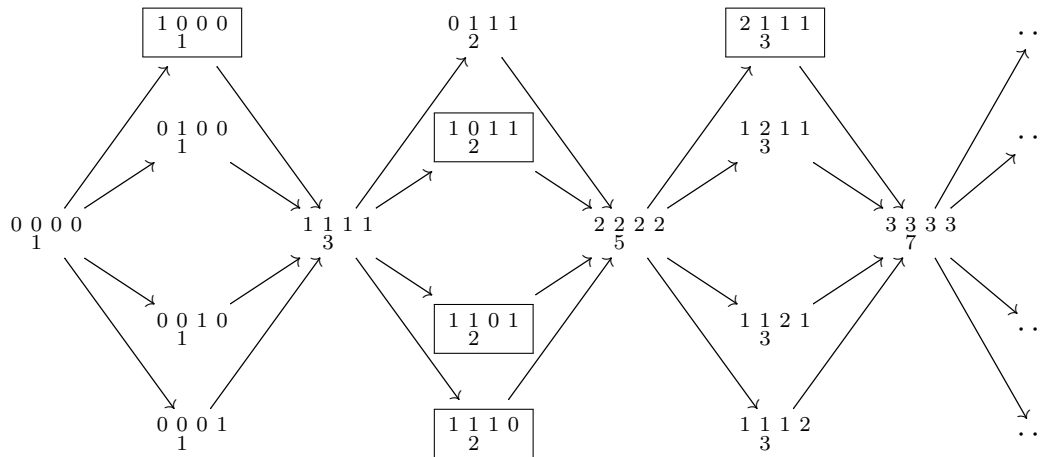

We framed the indecomposable direct summands of

$$T := T(1) \oplus \dots \oplus T(5) := \begin{pmatrix} 1 & 0 & 0 & 0 \\ 1 & & & \end{pmatrix} \oplus \begin{pmatrix} 1 & 0 & 1 & 1 \\ 2 & & & \end{pmatrix} \oplus \begin{pmatrix} 1 & 1 & 0 & 1 \\ 2 & & & \end{pmatrix} \oplus \begin{pmatrix} 1 & 1 & 1 & 0 \\ 2 & & & \end{pmatrix} \oplus \begin{pmatrix} 2 & 1 & 1 & 1 \\ 3 & & & \end{pmatrix}.$$

The module T is a tilting modules, and we have $B := \text{End}_A(T)^{\text{op}} \cong KQ'/I'$ where Q' is the quiver

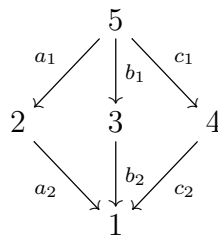

and I' is generated by $a_2a_1 + b_2b_1 + c_2c_1$.

The algebra A **minimal representation-infinite** if A is representation-infinite, and if for each non-zero idempotent $e \in A$ the factor algebra A/AeA is representation-finite.

Warning: There are different notions of minimal representation-infinite algebras.

Theorem 4.10 (Happel, Vossieck [HV83]). *Assume that K is algebraically closed. The following are equivalent:*

- (i) *A is minimal representation-infinite and has a preprojective component.*
- (ii) *A is the path algebra of some n -Kronecker quiver with $n \geq 2$ or B is a tame concealed algebra.*

The [Happel-Vossieck list](#) (which can be found in Ringel's book [R84]) contains the classification of all tame concealed algebras. This list also appears in the study of cluster algebras.

For further reading on concealed algebras we recommend [R84].

LITERATURE – CONCEALED ALGEBRAS

- [ARS97] M. Auslander, I. Reiten, S. Smalø, *Representation theory of Artin algebras*, Corrected reprint of the 1995 original. Cambridge Studies in Advanced Mathematics, 36. Cambridge University Press, Cambridge, 1997. xiv+425 pp.
- [HV83] D. Happel, D. Vossieck, *Minimal algebras of infinite representation type with preprojective component*, Manuscripta Math. 42 (1983), no. 2-3, 221–243.
- [R84] C.M. Ringel, *Tame algebras and integral quadratic forms*, Lecture Notes in Mathematics, 1099. Springer-Verlag, Berlin, 1984. xiii+376 pp.

[Back to Overview Tilted 4.](#)

4.4. Canonical algebras. Let K be algebraically closed, and let A be a finite-dimensional K -algebra.

For most results in this section, one can drop the assumption that K is algebraically closed. However some of the definitions (e.g. the definition of a *canonical algebra*) and also the proofs become much more involved in the general case.

By a *subcategory* we mean a full subcategory.

4.4.1. Separating families of components.

A component \mathcal{C} of Γ_A is **sincere** if for each simple A -module S there exists some $X \in \mathcal{C}$ with $[X : S] \neq 0$.

Recall that $X \in \text{ind}(A)$ is **sincere** if $[X : S] \neq 0$ for all simple A -modules S . Note that a sincere component \mathcal{C} of Γ_A does not necessarily contain a sincere module.

Let $\mathcal{T} = (\mathcal{T}_i)_{i \in I}$ be a family of components of Γ_A . Then \mathcal{T} is **sincere** if for each simple A -module S there exists some $i \in I$ and some $X \in \mathcal{T}_i$ with $[X : S] \neq 0$.

We define $\text{add}(\mathcal{T})$ in the obvious way.

The next definition is due to Malicki and Skowroński [MS19]. It is based on a more restricted definition by Ringel [R84]. Lenzing and de la Peña [LP99] introduced the similar concept of *separating exact subcategories*.

A family $\mathcal{T}_A = (\mathcal{T}_i)_{i \in I}$ of components of Γ_A is **separating** if the following hold:

- (i) Each \mathcal{T}_i is generalized standard, $\text{Hom}_A(\mathcal{T}_i, \mathcal{T}_j) = 0$ for all $i \neq j$, and \mathcal{T}_A is sincere.
- (ii) The set of components of Γ_A can be written as a disjoint union

$$\mathcal{P}_A \cup \mathcal{T}_A \cup \mathcal{I}_A$$

such that

$$\text{Hom}_A(\mathcal{I}_A, \mathcal{T}_A) = 0, \quad \text{Hom}_A(\mathcal{T}_A, \mathcal{P}_A) = 0, \quad \text{Hom}_A(\mathcal{I}_A, \mathcal{P}_A) = 0.$$

- (iii) Each homomorphism from \mathcal{P}_A to \mathcal{I}_A factors through $\text{add}(\mathcal{T}_A)$.

In this case, we say that \mathcal{T}_A **separates \mathcal{P}_A from \mathcal{I}_A** .

Note that \mathcal{P}_A and \mathcal{I}_A are uniquely determined by \mathcal{T}_A .

Here are some examples of algebras with a separating family of components (one can even use the more restricted definition by Ringel):

- (i) Tame representation-infinite hereditary algebras.
- (ii) Tame representation-infinite concealed algebras.
- (iii) Tubular algebras.

4.4.2. *Canonical algebras.* The following definition is due to Ringel [R84].

For $t \geq 2$ and $p = (p_1, \dots, p_t)$ with $p_i \geq 1$ for all i , let $Q = Q(p_1, \dots, p_t)$ be the quiver

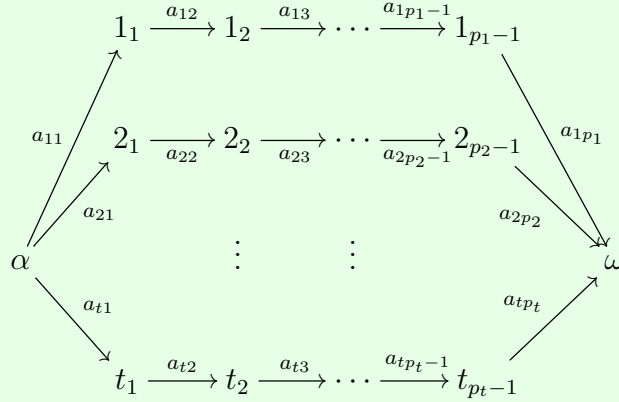

For $t = 2$, let $\lambda = 0$ and $C(p, \lambda) := KQ$. For $t \geq 3$, let $\lambda = (\lambda_3, \dots, \lambda_t) \in K^{t-2}$ where the λ_i are non-zero and pairwise different. Without loss of generality we assume that $\lambda_3 = 1$ and $p_i \geq 2$ for all i . Then let

$$C(p, \lambda) := KQ/I$$

where I is generated by the relations

$$\rho_i := a_{1p_1} \cdots a_{12}a_{11} + \lambda_i a_{2p_2} \cdots a_{22}a_{21} - a_{ip_i} \cdots a_{i2}a_{i1}$$

for $3 \leq i \leq t$. The algebra $C(p, \lambda)$ is a **canonical algebra** of type p .

The standard references for canonical algebras are [R84, R90].

Canonical algebras are representation-infinite.

With $p = (p_1, \dots, p_t)$ as above, let

$$\chi_p := 2 - \sum_{i=1}^t \left(1 - \frac{1}{p_i}\right).$$

Proposition 4.11. *The following hold:*

- (i) $C(p, \lambda)$ is tame domestic if and only if $\chi_p > 0$.
- (ii) $C(p, \lambda)$ is a tubular algebra if and only if $\chi_p = 0$.
- (iii) $C(p, \lambda)$ is wild if and only if $\chi_p < 0$.

One of the key characteristics of a canonical algebra $A = C(p, \lambda)$ is the existence of a sincere separating family of components of Γ_A :

Let $A := C(p, \lambda)$ be a canonical algebra. Let \mathcal{P} be the subcategory of all $X \in \text{mod}(A)$ such that $X_a: X_{s(a)} \rightarrow X_{t(a)}$ is a monomorphism for each $a \in Q_1$, but not all X_a are isomorphisms. Dually, \mathcal{I} is the subcategory of all $X \in \text{mod}(A)$ such that $X_a: X_{s(a)} \rightarrow X_{t(a)}$ is an epimorphism for each $a \in Q_1$, but not all X_a

are isomorphisms. Let \mathcal{T} be the subcategory of all $X \in \text{mod}(A)$ such that no indecomposable direct summand of X is in \mathcal{P} or \mathcal{I} .

For $X \in \text{mod}(A)$ define

$$\iota(X) := \dim(X_\alpha) - \dim(X_\omega).$$

Proposition 4.12. *Let $A = C(p, \lambda)$, and let \mathcal{P} , \mathcal{T} and \mathcal{I} be defined as above. A module $X \in \text{mod}(A)$ is in \mathcal{P} , \mathcal{T} or \mathcal{I} if and only if for each indecomposable direct summand Y of X we have $\iota(Y) < 0$, $\iota(Y) = 0$ or $\iota(Y) > 0$, respectively.*

Proposition 4.13. *Let $A = C(p, \lambda)$, and let \mathcal{P} , \mathcal{T} and \mathcal{I} be defined as above. Each component \mathcal{C} of Γ_A is a subcategory of one of the subcategories \mathcal{P} , \mathcal{T} or \mathcal{I} .*

Let \mathcal{P}_A , \mathcal{T}_A and \mathcal{I}_A be the components of Γ_A which are contained in \mathcal{P} , \mathcal{T} and \mathcal{I} , respectively.

Theorem 4.14 (Ringel [R84]). *Let $A = C(p, \lambda)$, and let \mathcal{P} , \mathcal{T} and \mathcal{I} be defined as above. Then the following hold:*

- (i) $\mathcal{T}_A = (\mathcal{T}_x)_{x \in \mathbb{P}^1(K)}$ is a separating family of components of Γ_A which separates \mathcal{P}_A from \mathcal{I}_A .
- (ii) Each \mathcal{T}_x is a standard stable tube. There are $x_1, \dots, x_t \in \mathbb{P}^1(K)$ such that the rank of \mathcal{T}_{x_i} is p_i for $1 \leq i \leq t$. All other tubes \mathcal{T}_x have rank 1.

The modules in \mathcal{T} can be described very explicitly.

4.4.3. *Weighted projective lines.* Let $t \geq 3$. A **weighted projective line** $\mathbb{X} := \mathbb{X}(p, \lambda)$ is given by a **weight sequence** $p = (p_1, \dots, p_t)$ of integers $p_i \geq 1$, and a **parameter sequence** $\lambda = (\lambda_3, \dots, \lambda_t) \in K^{t-3}$ where the λ_i are non-zero and pairwise different. Without loss of generality we assume that $\lambda_3 = 1$.

Let $\mathbb{L} = \mathbb{L}(p, \lambda)$ be the abelian group generated by elements x_1, \dots, x_t modulo the relations $p_i x_i = p_j x_j$ for all $1 \leq i, j \leq t$. We call $c := p_i x_i$ the **canonical element** of \mathbb{L} . Let $m := \text{l.c.m.}(p_1, \dots, p_t)$. Then

$$\begin{aligned} \delta: \mathbb{L} &\rightarrow \mathbb{Z} \\ x_i &\mapsto \frac{m}{p_i} \end{aligned}$$

is the **degree map**.

Let

$$S := S(p, \lambda) := K[X_1, \dots, X_t]/I$$

where I is the ideal generated by the relations

$$\rho_i := X_1^{p_1} + \lambda_i X_2^{p_2} - X_i^{p_i} = 0$$

for $3 \leq i \leq t$.

S is \mathbb{L} -graded with X_i of degree x_i .

Let $\text{mod}^{\mathbb{L}}(S)$ be the category of finitely generated \mathbb{L} -graded S -modules, and let $\text{mod}_0^{\mathbb{L}}(S)$ be the Serre subcategory of $\text{mod}^{\mathbb{L}}(S)$ consisting of the finite-dimensional S -modules in $\text{mod}^{\mathbb{L}}(S)$.

Let

$$\text{coh}(\mathbb{X}) := \text{mod}^{\mathbb{L}}(S)/\text{mod}_0^{\mathbb{L}}(S)$$

be the **category of coherent sheaves** on the weighted projective line \mathbb{X} .

The category $\text{coh}(\mathbb{X})$ was introduced and studied by Geigle and Lenzing [GL87].

$\text{coh}(\mathbb{X})$ is a connected noetherian abelian K -category.

Let $\text{coh}_0(\mathbb{X})$ be the subcategory of all $X \in \text{coh}(\mathbb{X})$ such that X has finite length, and let $\text{coh}_+(\mathbb{X})$ be the subcategory of all $X \in \text{coh}(\mathbb{X})$ such that $\text{Hom}_{\mathbb{X}}(\text{coh}_0(\mathbb{X}), X) = 0$. The objects in $\text{coh}_0(\mathbb{X})$ are **torsion objects** and the objects in $\text{coh}_+(\mathbb{X})$ are **vector bundles**.

For each $X \in \text{coh}(\mathbb{X})$ we have $X = X_0 \oplus X_+$ with $X_0 \in \text{coh}_0(\mathbb{X})$ and $X_+ \in \text{coh}_+(\mathbb{X})$. There is a family

$$(\mathcal{T}_x)_{x \in \mathbb{P}^1(K)}$$

of Hom orthogonal, uniserial abelian subcategories \mathcal{T}_x such that

$$\text{coh}_0(\mathbb{X}) = \text{add} \left(\bigcup_{x \in \mathbb{P}^1(K)} \mathcal{T}_x \right).$$

Let

$$\omega := (t-2)c - \sum_{i=1}^t x_i$$

be the **dualizing element** of \mathbb{L} .

The group \mathbb{L} acts on $\text{mod}^{\mathbb{L}}(S)$ by degree shift $M \mapsto M(x)$.

$\text{coh}(\mathbb{X})$ has **Serre duality** in the form of functorial isomorphisms

$$\text{Hom}_{\mathbb{X}}(X, Y(\omega)) \cong D \text{Ext}_{\mathbb{X}}^1(Y, X)$$

for all $X, Y \in \text{coh}(\mathbb{X})$.

Theorem 4.15 (Geigle, Lenzing [GL87, GL91]). *There is a triangle equivalence*

$$\mathcal{D}^b(\text{coh}(\mathbb{X})) \simeq \mathcal{D}^b(\text{mod}(C(p, \lambda))).$$

The isomorphism class of $C(p, \lambda)$ depends on the choice of (p, λ) . This is explained in [GL91, Proposition 9.1]. In particular, $\text{coh}(\mathbb{X}(p, \lambda)) \simeq \text{coh}(\mathbb{X}(p', \lambda'))$ if and only if $C(p, \lambda) \cong C(p', \lambda')$.

Standard references for weighted projective lines and their connection to canonical algebras are [GL87, GL91]. For a survey on weighted projective lines we refer to [CK09]. We also recommend [BKL13].

4.4.4. *Concealed canonical and quasi-canonical algebras.* Let $\mathbb{X} := \mathbb{X}(p, \lambda)$ be a weighted projective line.

$T \in \text{coh}(\mathbb{X})$ is a **tilting sheaf** if the following hold:

(i) $\text{Ext}_{\mathbb{X}}^1(T, T) = 0$.

(ii) If $X \in \text{coh}(\mathbb{X})$ with $\text{Hom}_{\mathbb{X}}(T, X) = 0$ and $\text{Ext}_{\mathbb{X}}^1(T, X) = 0$, then $X = 0$.

If such a T is a vector bundle, then T is a **tilting bundle**.

The following definition (in a slightly different but equivalent form) is due to Lenzing and Meltzer [LM96].

Let $T \in \text{coh}(\mathbb{X})$ be a tilting bundle. Then

$$B := \text{End}_{\mathbb{X}}(T)^{\text{op}}$$

is a **concealed canonical algebra**.

Concealed canonical algebras are quasi-tilted.

The next definition is taken from [LS96]:

A finite-dimensional K -algebra B is **quasi-canonical** if there is a triangle equivalence

$$\mathcal{D}^b(\text{mod}(B)) \rightarrow \mathcal{D}^b(\text{mod}(C(p, \lambda)))$$

for some (p, λ) .

Concealed canonical algebras are quasi-canonical.

Theorem 4.16 (Lenzing, de la Peña [LP99]). *Let $\mathcal{T}_A = (\mathcal{T}_i)_{i \in I}$ be a separating family of components of Γ_A . The following are equivalent:*

- (i) *Each \mathcal{T}_i is a stable tube.*
- (ii) *A is concealed canonical.*

Theorem 4.17 (Lenzing, Skowroński [LS96]). *Let $\mathcal{T}_A = (\mathcal{T}_i)_{i \in I}$ be a separating family of components of Γ_A . The following are equivalent:*

- (i) *Each \mathcal{T}_i is a semiregular tube.*
- (ii) *A is quasi-tilted and quasi-canonical.*

Further generalizations of these two theorems can be found in [MS19].

LITERATURE – CANONICAL ALGEBRAS

- [BKL13] M. Barot, D. Kussin, H. Lenzing, *Extremal properties for concealed-canonical algebras*. Colloq. Math. 130 (2013), no. 2, 183–219.
- [CK09] X. Chen, H. Krause, *Introduction to coherent sheaves on weighted projective lines*. Preprint (2009), 62 pp., arXiv:0911.4473
- [GL87] W. Geigle, H. Lenzing, *A class of weighted projective curves arising in representation theory of finite-dimensional algebras*. In: Singularities, representation of algebras, and vector bundles (Lambrecht, 1985), Lecture Notes in Math., vol. 1273, Springer, Berlin, 1987, pp. 265–297.
- [GL91] W. Geigle, H. Lenzing, *Perpendicular categories with applications to representations and sheaves*, J. Algebra 144 (1991), no. 2, 273–343.
- [H01] D. Happel, *A characterization of hereditary categories with tilting object*. Invent. Math. 144 (2001), 381–398.
- [LM96] H. Lenzing, H. Meltzer, *Tilting sheaves and concealed-canonical algebras*. Representation theory of algebras (Cocoyoc, 1994), 455–473, CMS Conf. Proc., 18, Amer. Math. Soc., Providence, RI, 1996.
- [LP99] H. Lenzing, J.A. de la Peña, *Concealed-canonical algebras and separating tubular families*. Proc. London Math. Soc. (3) 78 (1999), no. 3, 513–540.
- [LS96] H. Lenzing, A. Skowroński, *Quasi-tilted algebras of canonical type*. Colloq. Math. 71 (1996), no. 2, 161–181.
- [MS19] P. Malicki, A. Skowroński, *The structure and homological properties of generalized standard Auslander-Reiten components*. J. Algebra 518 (2019), 1–39.
- [R84] C.M. Ringel, *Tame algebras and integral quadratic forms*. Lecture Notes in Mathematics, 1099. Springer-Verlag, Berlin, 1984. xiii+376 pp.
- [R90] C.M. Ringel, *The canonical algebras*. With an appendix by William Crawley-Boevey. Banach Center Publ., 26, Part 1, Topics in algebra, Part 1 (Warsaw, 1988), 407–432, PWN, Warsaw, 1990.
- [RR06] I. Reiten, C.M. Ringel, *Infinite dimensional representations of canonical algebras*. Canad. J. Math. 58 (2006), no. 1, 180–224.

Back to Overview Tilted 4.

4.5. **Quasi-tilted algebras.** Let A be a finite-dimensional K -algebra.

4.5.1. *Almost hereditary algebras.*

A is **almost hereditary** if the following hold:

- (i) $\text{gl. dim}(A) \leq 2$.
- (ii) If $X \in \text{ind}(A)$, then $\text{proj. dim}(X) \leq 1$ or $\text{inj. dim}(X) \leq 1$.

Examples:

- (i) Tilted algebras are almost hereditary.
- (ii) Canonical algebras are almost hereditary.
- (iii) Let $A = KQ/I$ where Q is the quiver

$$1 \begin{array}{c} \xrightarrow{a} \\ \xleftarrow{b} \end{array} 2$$

and I is generated by ba . Then

$$\text{gl. dim}(A) = 2 \quad \text{and} \quad \text{proj. dim}(S(1)) = \text{inj. dim}(S(1)) = 2.$$

Thus A is not almost hereditary.

4.5.2. *Quasi-tilted algebras.*

An abelian category \mathcal{C} is **hereditary** if $\text{Ext}_{\mathcal{C}}^2(X, Y) = 0$ for all $X, Y \in \mathcal{C}$.

Let \mathcal{H} be a hereditary abelian K -category with finite-dimensional Hom- und Ext-spaces.

Examples:

- (i) Let Q be an acyclic quiver. Then $\mathcal{H} := \text{mod}(KQ)$ has the properties listed above.
- (ii) Let \mathbb{X} be a weighted projective line, and let $\text{coh}(\mathbb{X})$ be the category of coherent sheaves on \mathbb{X} . Then $\mathcal{H} := \text{coh}(\mathbb{X})$ has the properties listed above.

$T \in \mathcal{H}$ is a **tilting object** if the following hold:

- (i) $\text{Ext}_{\mathcal{H}}^1(T, T) = 0$.
- (ii) If $\text{Hom}_{\mathcal{H}}(T, X) = 0$ and $\text{Ext}_{\mathcal{H}}^1(T, X) = 0$ for some $X \in \mathcal{H}$, then $X = 0$.

Let $T \in \mathcal{H}$ be a tilting object. Then

$$B := \text{End}_{\mathcal{H}}(T)^{\text{op}}$$

is a **quasi-tilted algebra**.

In this case, we have

$$\mathcal{D}^b(\mathcal{H}) \simeq \mathcal{D}^b(\text{mod}(B)).$$

The following two theorems are quite amazing.

Theorem 4.18 (Happel, Reiten, Smalø [HRS96, Theorem II.2.3]). *The following are equivalent:*

- (i) A is quasi-tilted.
- (ii) A is almost hereditary.

Theorem 4.19 (Happel [H01, Theorem 3.1]). *Let K be algebraically closed, and let \mathcal{H} be a connected hereditary abelian K -category with finite-dimensional Hom- and Ext-spaces. Suppose that \mathcal{H} contains a tilting object. Then*

$$\mathcal{D}^b(\mathcal{H}) \simeq \mathcal{D}^b(\text{mod}(KQ)) \quad \text{or} \quad \mathcal{D}^b(\mathcal{H}) \simeq \mathcal{D}^b(\text{coh}(\mathbb{X}))$$

where Q is a connected acyclic quiver and \mathbb{X} is a weighted projective line.

In other words, if K is algebraically closed and A is quasi-tilted, then A is derived equivalent to a tilted algebra or to a concealed canonical algebra.

Theorem 4.20 ([HRS96, Corollary II.3.6]). *Let A be representation-finite. Then the following are equivalent:*

- (i) A is quasi-tilted.
- (ii) A is tilted.

There are many examples of quasi-tilted algebras which are not tilted, see [HRS96, Proposition III.3.11].

LITERATURE – QUASI-TILTED ALGEBRAS

- [HRS96] D. Happel, I. Reiten, S. Smalø, *Tilting in abelian categories and quasitilted algebras*. Mem. Amer. Math. Soc. 120 (1996), no. 575, viii+88 pp.
- [H01] D. Happel, *A characterization of hereditary categories with tilting object*. Invent. Math. 144 (2001), no. 2, 381–398.

Back to Overview Tilted 4.

4.6. **Shod algebras.** Let A be a finite-dimensional K -algebra.

The following definition is due to Coelho and Lanzilotta [CL99].

A is a **shod algebra** if for each $X \in \text{ind}(A)$ we have $\text{proj. dim}(X) \leq 1$ or $\text{inj. dim}(X) \leq 1$.

Here *shod* stands for *small homological dimension*.

Examples:

- (i) Almost hereditary algebras are shod algebras.
- (ii) Let $A = KQ/I$ where Q is the quiver

$$1 \xrightarrow{a} 2 \xrightarrow{b} 3 \xrightarrow{c} 4$$

and I is generated by $\{ba, cb\}$. Then A is a shod algebra and $\text{gl. dim}(A) = 3$. In particular, A is not almost hereditary.

Theorem 4.21 ([HRS96, Proposition II.1.1]). *If A is a shod algebra, then*

$$\text{gl. dim}(A) \leq 3.$$

A **path in $\text{mod}(A)$** is a diagram

$$X_1 \xrightarrow{f_1} X_2 \xrightarrow{f_2} \cdots \xrightarrow{f_{t-1}} X_t$$

with $X_i \in \text{ind}(A)$ and $f_i \neq 0$ for all i . In this case, we write $X_1 \rightsquigarrow X_t$.

The **length** of such a path is $|\{1 \leq i \leq t-1 \mid f_i \text{ is not an isomorphism}\}|$.

Let

$$\begin{aligned} \mathcal{L}(A) &:= \{X \in \text{ind}(A) \mid \text{if } Y \rightsquigarrow X, \text{ then } \text{proj. dim}(Y) \leq 1\}, \\ \mathcal{R}(A) &:= \{X \in \text{ind}(A) \mid \text{if } X \rightsquigarrow Y, \text{ then } \text{inj. dim}(Y) \leq 1\}. \end{aligned}$$

Theorem 4.22 (Coelho, Lanzilotta [CL99]). *The following are equivalent:*

- (i) A is a shod algebra.
- (ii) $\text{ind}(A) = \mathcal{L}(A) \cup \mathcal{R}(A)$.

The following definition is again due to Coelho and Lanzilotta [CL03].

A is a **weakly shod algebra** if there exists some $m \geq 1$ such that the length of each path of the form

$$I = X_1 \xrightarrow{f_1} X_2 \xrightarrow{f_2} \cdots \xrightarrow{f_{t-1}} X_t = P$$

where I is indecomposable injective and P is indecomposable projective is bounded by m .

Each shod algebra is a weakly shod algebra.

Theorem 4.23 (Coelho, Lanzilotta [CL03, Section 2.5]). *The following are equivalent:*

- (i) A is a weakly shod algebra.
- (ii) (a) $\mathcal{L}(A) \cup \mathcal{R}(A)$ is cofinite in $\text{ind}(A)$.
 (b) None of the components of Γ_A which are not semiregular, contain oriented cycles.

(Condition (ii)(a) means that there are only finitely many $X \in \text{ind}(A)$ with $X \notin \mathcal{L}(A) \cup \mathcal{R}(A)$, up to isomorphism.)

Theorem 4.24 ([CL03, Section 6.1]). *Weakly shod algebras are triangular.*

LITERATURE – SHOD ALGEBRAS

- [BT05] J. Bélanger, C. Tosar, *Shod string algebras*. *Comm. Algebra* 33 (2005), no. 8, 2465–2487.
- [CL99] F. Coelho, M. Lanzilotta, *Algebras with small homological dimensions*. *Manuscripta Math.* 100 (1999), no. 1, 1–11.
- [CL03] F. Coelho, M. Lanzilotta, *Weakly shod algebras*. *J. Algebra* 265 (2003), no. 1, 379–403.
- [HRS96] D. Happel, I. Reiten, S. Smalø, *Tilting in abelian categories and quasitilted algebras*. *Mem. Amer. Math. Soc.* 120 (1996), no. 575, viii+88 pp.

[Back to Overview Tilted 4.](#)

4.7. Tubular algebras. In this subsection, let K be algebraically closed, and let A be a finite-dimensional K -algebra.

The standard reference for tubular algebras is Ringel’s book [R84].

Tubular algebras form a small but interesting class of tame algebras. The definition of a tubular algebra is technical and requires knowledge on the representation theory of tame hereditary algebras (and more generally of tame concealed algebras) and on the technique of one-point extensions (and more generally of branch extensions). But having swallowed the definition, one gets rewarded by some nice theory.

We need three ingredients for the definition of a tubular algebra:

- (i) Let A be a tame concealed algebra. Then the projective line $I := \mathbb{P}^1(K)$ indexes the tubes in Γ_A . For $i \in I$ let \mathcal{T}_i be the associated tube. There are at most three elements $i \in I$ with $\text{rk}(\mathcal{T}_i) \geq 2$.
- (ii) Let E_1, \dots, E_r be a collection of pairwise non-isomorphic quasi-simple regular A -modules, and let B_1, \dots, B_r be branches. Let

$$B := A[E_1, B_1][E_2, B_2] \cdots [E_r, B_r]$$

be the associated iterated branch extension. (For details on branch extensions we refer to Section 10.3 on one-point extension algebras.)

- (iii) Define a map

$$t: I \rightarrow \mathbb{N}$$

$$i \mapsto \text{rk}(\mathcal{T}_i) + \sum_{\substack{1 \leq k \leq r \\ E_k \in \mathcal{T}_i}} |B_k|.$$

Let i_1, \dots, i_s be the elements in I with $n_i := t(i) \geq 2$. Without loss of generality we assume that $n_1 \geq \dots \geq n_s$. Then (n_1, \dots, n_s) is the **tubular type of B** .

The algebra B is a **tubular algebra** provided (n_1, \dots, n_s) belongs to the following list of tubular types:

$$(2, 2, 2, 2), (3, 3, 3), (4, 4, 2), (6, 3, 2).$$

The number of simple modules of a tubular algebra is 6, 8, 9 or 10.

There is also the notion of a **cotubular algebra** which is defined by iterated branch coextensions.

Theorem 4.25 ([R84]). *Tubular algebras are also cotubular and vice versa.*

This leads to some intriguing symmetry results.

One can also define tubular algebras over fields K which are not algebraically closed. For this more general definition we refer to [K09].

The category $\text{mod}(A)$ of a tubular algebra A has a beautiful description due to Ringel [R84]. His classification result turns out to have a lot in common with Atiyah's [A57] classification of vector bundles on elliptic curves.

Theorem 4.26 ([R84]). *The AR quiver Γ_A of a tubular algebra A looks as follows: There is a preprojective component \mathcal{P}_A , a preinjective component \mathcal{I}_A and for each $\gamma \in \mathbb{Q}_{\geq 0} \cup \{\infty\}$ there is a $\mathbb{P}^1(K)$ -family \mathcal{T}_γ of tubes such that $\text{Hom}_A(\mathcal{T}_\gamma, \mathcal{T}_\delta) = 0$ for all $\gamma > \delta$. (The family \mathcal{T}_0 might contain projective modules, and \mathcal{T}_∞ might contain injective modules.) Each component of Γ_A is a standard component.*

For a tubular algebra A and $X \in \text{mod}(A)$ let

$$q_A(X) := \sum_{i=0}^2 \dim \text{End}_A(X) - \dim \text{Ext}_A^1(X, X) + \dim \text{Ext}_A^2(X, X).$$

This value only depends on the dimension vector $\underline{\dim}(X)$. This yields an integral quadratic form $q_A: \mathbb{Z}^n \rightarrow \mathbb{Z}$. (Here $n = n(A)$ is the number of simple A -modules.) The form q_A is positive semidefinite.

Let

$$\Delta_A^+ := \{x \in \mathbb{N}^n \mid q_A(x) = 0, 1\} \setminus \{0\}$$

be the set of positive roots of q_A .

Theorem 4.27 ([R84]). *For a tubular algebra A we have*

$$\{\underline{\dim}(X) \mid X \in \text{ind}(A)\} = \Delta_A^+.$$

Theorem 4.28 ([HR86]). *Each tubular algebra is derived equivalent to a tubular canonical algebra.*

Theorem 4.29 ([R84]). *Tubular algebras are tame (non-domestic of linear growth).*

Theorem 4.30 ([HR86]). *Tubular algebras are derived tame.*

The derived category $\mathcal{D}^b(\text{mod}(A))$ of a tubular algebra A is described in [HR86].

Proposition 4.31 ([R84]). *Tubular algebras are quasi-tilted.*

Proposition 4.32 ([R84]). *Let A be a tubular algebra, and let $T \in \text{mod}(A)$ be a preprojective tilting module. Then $B := \text{End}_A(T)^{\text{op}}$ is again a tubular algebra.*

There is a beautiful link between Geigle and Lenzing’s theory of sheaves on weighted projective lines and the representation theory of canonical algebras. The tubular cases are particularly well understood and interesting. We refer to [LM93] for more details.

Examples: The following algebras are tubular. The red (resp. blue) vertex shows how it is obtained as a one-point extension (resp. one-point coextension) from a tame concealed algebra.

- (i) For $\lambda \in K \setminus \{0, 1\}$ let $A_\lambda = KQ/I$ where Q is the quiver

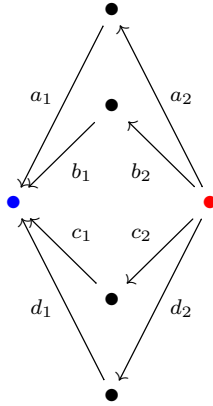

and I is generated by

$$\{a_1a_2 + b_1b_2 + c_1c_2, a_1a_2 + \lambda b_1b_2 + d_1d_2\}.$$

Then A_λ is a tubular algebra of type $(2, 2, 2, 2)$. Furthermore, we have $A_\lambda \cong A_\mu$ if and only if $\mu \in \{\lambda, 1 - \lambda, \lambda^{-1}, (1 - \lambda)^{-1}, \lambda(\lambda - 1)^{-1}, (\lambda - 1)\lambda^{-1}\}$.

- (ii) Let $A = KQ/I$ where Q is the quiver

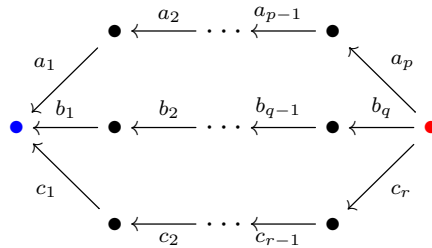

and I is generated by $a_1 \cdots a_p + b_1 \cdots b_q + c_1 \cdots c_r$. Then A is a tubular algebra if and only if $(p, q, r) \in \{(3, 3, 3), (4, 4, 2), (6, 3, 2)\}$.

- (iii) Let $A = KQ/I$ where Q is the quiver

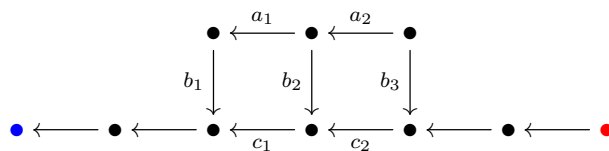

and I is generated by $\{b_1a_1 - c_1b_2, b_2a_2 - c_2b_3\}$.

The algebras in (i) and (ii) are exactly the tubular canonical algebras.

LITERATURE – TUBULAR ALGEBRAS

- [A57] M. Atiyah, *Vector bundles over an elliptic curve*. Proc. London Math. Soc. (3) 7 (1957), 414–452.
- [DK20] P. Dowbor, Y. Kim, *Computational classification of tubular algebras*. Fund. Inform. 177 (2020), no. 1, 39–67.
- [HR86] D. Happel, C.M. Ringel, *The derived category of a tubular algebra*. Representation theory, I (Ottawa, Ont., 1984), 156–180, Lecture Notes in Math., 1177, Springer, Berlin, 1986.
- [K09] D. Kussin, *Noncommutative curves of genus zero: related to finite dimensional algebras*. Mem. Amer. Math. Soc. 201 (2009), no. 942, x+128 pp.
- [LM93] H. Lenzing, H. Meltzer, *Sheaves on a weighted projective line of genus one, and representations of a tubular algebra*. Representations of algebras (Ottawa, ON, 1992), 313–337, CMS Conf. Proc., 14, Amer. Math. Soc., Providence, RI, 1993.
- [LP05] Y. Lin, L. Peng, *Elliptic Lie algebras and tubular algebras*. Adv. Math. 196 (2005), no. 2, 487–530.
- [R84] C.M. Ringel, *Tame algebras and integral quadratic forms*. Lecture Notes in Mathematics, 1099. Springer-Verlag, Berlin, 1984. xiii+376 pp.

[Back to Overview Tilted 4.](#)

4.8. Auslander algebras. Let A be a finite-dimensional K -algebra.

$M \in \text{mod}(A)$ is an **additive generator** of $\text{mod}(A)$ if

$$\text{add}(M) = \text{mod}(A).$$

Obviously, A is representation-finite if and only if there exists such an additive generator.

Theorem 4.33 (Auslander Correspondence [ARS97]). *There are mutually inverse bijections F and G between the sets*

$$\{A \mid A \text{ representation-finite fin.-dim. } K\text{-algebra}\} / \sim$$

and

$$\{B \mid B \text{ fin.-dim. } K\text{-algebra with } \text{dom. dim}(B) \geq 2 \geq \text{gl. dim}(B)\} / \sim$$

defined by $F: A \mapsto B := \text{End}_A(M)^{\text{op}}$ with M a additive generator of $\text{mod}(A)$, and $G: B \mapsto A := \text{End}_B(Q)^{\text{op}}$ with Q an additive generator of $\text{proj-inj}(B)$.

By \sim we mean “up to Morita equivalence”.

For an additive generator M of $\text{mod}(A)$ the algebra

$$B := \text{End}_A(M)^{\text{op}}$$

is the **Auslander algebra** of A .

Example: Let $A = KQ/I$ where Q is the quiver

$$1 \begin{array}{c} \xrightarrow{a} \\ \xleftarrow{b} \end{array} 2$$

and I is generated by $\{ab, ba\}$. Here is the Auslander-Reiten quiver of A (one needs to identify the leftmost and the rightmost vertex):

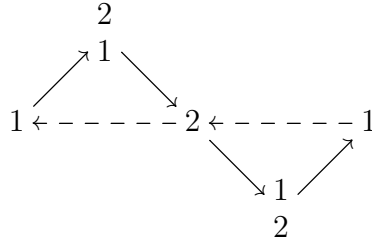

Let $B = KQ'/I'$ where Q' is the quiver

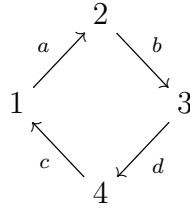

and I' is generated by $\{ba, cd\}$. The indecomposable projective B -modules $P(i)$ and the indecomposable injective B -modules $I(i)$ look as follows:

$$\begin{array}{cccc}
 P(1) = \begin{array}{c} 1 \\ 2 \end{array} & P(2) = \begin{array}{c} 2 \\ 3 \\ 4 \end{array} & P(3) = \begin{array}{c} 3 \\ 4 \end{array} & P(4) = \begin{array}{c} 4 \\ 1 \\ 2 \end{array} \\
 I(1) = \begin{array}{c} 4 \\ 1 \end{array} & I(2) = \begin{array}{c} 4 \\ 1 \\ 2 \end{array} & I(3) = \begin{array}{c} 2 \\ 3 \end{array} & I(4) = \begin{array}{c} 2 \\ 3 \\ 4 \end{array}
 \end{array}$$

Then B is the Auslander algebra of A . For $Q := P(2) \oplus P(4)$ we have $A \cong \text{End}_B(Q)^{\text{op}}$.

For $n \geq 1$, $M \in \text{mod}(A)$ is an **n -cluster-tilting module** if

$$\begin{aligned}
 \text{add}(M) &= \{X \in \text{mod}(A) \mid \text{Ext}_A^i(M, X) = 0 \text{ for } 1 \leq i \leq n-1\} \\
 &= \{X \in \text{mod}(A) \mid \text{Ext}_A^i(X, M) = 0 \text{ for } 1 \leq i \leq n-1\}.
 \end{aligned}$$

For $n = 1$, the above conditions on the vanishing of Ext groups are empty. Therefore $M \in \text{mod}(A)$ is 1-cluster-tilting if and only if $\text{add}(M) = \text{mod}(A)$. In this case, $\text{End}_A(M)^{\text{op}}$ is Morita equivalent to an Auslander algebra. In particular, A is representation-finite.

There are numerous examples of 2-cluster-tilting modules. The study of n -cluster-tilting modules for $n \geq 3$ is less developed.

The following groundbreaking result due to Iyama generalizes Theorem 4.33.

Theorem 4.34 (Higher Auslander correspondence [I07a, I07b]). *There are mutually inverse bijections between the sets*

$$\{(A, M) \mid A \text{ fin.-dim. } K\text{-algebra, } M \text{ } n\text{-cluster-tilting in } \text{mod}(A)\} / \sim$$

and

$$\{B \mid B \text{ fin.-dim. } K\text{-algebra with } \text{dom. dim}(B) \geq n + 1 \geq \text{gl. dim}(B)\} / \sim$$

In the theorem above we have $(A, M) \sim (A', M')$ if there is an equivalence $\text{mod}(A) \rightarrow \text{mod}(A')$ which restricts to an equivalence $\text{add}(M) \rightarrow \text{add}(M')$, and $B \sim B'$ if there is an equivalence $\text{mod}(B) \rightarrow \text{mod}(B')$.

For $n \geq 1$, a finite-dimensional K -algebra B is an **n -Auslander algebra** if $\text{dom. dim}(B) \geq n + 1 \geq \text{gl. dim}(B)$.

In this case, if one of these dimensions is equal to $n + 1$, then the other dimension is also $n + 1$.

Example: For $n \geq 1$, let $B = KQ/I$ where Q is the quiver

$$1 \xrightarrow{a_1} 2 \xrightarrow{a_2} \dots \xrightarrow{a_{n+1}} n + 2$$

and I is generated by $\{a_{i+1}a_i \mid 1 \leq i \leq n\}$. Then B is an n -Auslander algebra.

LITERATURE – AUSLANDER ALGEBRAS

[ARS97] M. Auslander, I. Reiten, S. Smalø, *Representation theory of Artin algebras*, Corrected reprint of the 1995 original. Cambridge Studies in Advanced Mathematics, 36. Cambridge University Press, Cambridge, 1997. xiv+425 pp.

[I07a] O. Iyama, *Higher-dimensional Auslander-Reiten theory on maximal orthogonal subcategories*, Adv. Math. 210 (2007), no. 1, 22–50.

[I07b] O. Iyama, *Auslander correspondence*, Adv. Math. 210 (2007), no. 1, 51–82.

[Back to Overview Tilted 4.](#)

4.9. n -representation-(in)finite and n -hereditary algebras. Let A be a finite-dimensional K -algebra. In this subsection, we follow [HIO14]. For further reading we recommend [HI11a, HI11b, I11, IO11, IO13].

4.9.1. *Higher Nakayama functors.*

Let

$$\nu := D \operatorname{Hom}_A(-, {}_A A) : \operatorname{mod}(A) \rightarrow \operatorname{mod}(A)$$

and

$$\nu^- := \operatorname{Hom}_A(D(A_A), -) : \operatorname{mod}(A) \rightarrow \operatorname{mod}(A)$$

be the **Nakayama functors**.

They restrict to equivalences

$$\operatorname{proj}(A) \begin{array}{c} \xleftarrow{\nu} \\ \xrightarrow{\nu^-} \end{array} \operatorname{inj}(A)$$

which are quasi-inverses of each other.

These equivalences yield equivalences of homotopy categories

$$\mathcal{K}^b(\operatorname{proj}(A)) \begin{array}{c} \xleftarrow{\nu} \\ \xrightarrow{\nu^-} \end{array} \mathcal{K}^b(\operatorname{inj}(A))$$

which are quasi-inverses of each other.

If $\operatorname{gl. dim}(A) < \infty$, then the inclusions

$$\mathcal{K}^b(\operatorname{proj}(A)) \rightarrow \mathcal{D}^b(\operatorname{mod}(A)) \quad \text{and} \quad \mathcal{K}^b(\operatorname{inj}(A)) \rightarrow \mathcal{D}^b(\operatorname{mod}(A))$$

are triangle equivalences. Thus we obtain two triangle equivalences

$$\mathcal{D}^b(\operatorname{mod}(A)) \begin{array}{c} \xleftarrow{\nu} \\ \xrightarrow{\nu^-} \end{array} \mathcal{D}^b(\operatorname{mod}(A))$$

which are again quasi-inverses of each other.

Let

$$[-] : \mathcal{D}^b(\operatorname{mod}(A)) \rightarrow \mathcal{D}^b(\operatorname{mod}(A))$$

be the shift automorphism. For $n \in \mathbb{Z}$ set $[n] := [-]^n$.

Define

$$\nu_n := \nu \circ [-n] : \mathcal{D}^b(\operatorname{mod}(A)) \rightarrow \mathcal{D}^b(\operatorname{mod}(A))$$

and

$$\nu_n^- := \nu^- \circ [n] : \mathcal{D}^b(\operatorname{mod}(A)) \rightarrow \mathcal{D}^b(\operatorname{mod}(A)).$$

Let

$$\tau_n := D \operatorname{Ext}_A^n(-, {}_A A) : \operatorname{mod}(A) \rightarrow \operatorname{mod}(A)$$

and

$$\tau_n^- := \operatorname{Ext}_A^n(D(A_A), -) : \operatorname{mod}(A) \rightarrow \operatorname{mod}(A).$$

We have

$$\tau_n \cong H^0(\nu_n(-)): \text{mod}(A) \rightarrow \text{mod}(A)$$

and

$$\tau_n^- \cong H^0(\nu_n^(-)): \text{mod}(A) \rightarrow \text{mod}(A).$$

4.9.2. n -representation-finite algebras.

Let $n \geq 1$. Recall that $T \in \text{mod}(A)$ is an **n -cluster-tilting module** if

$$\begin{aligned} \text{add}(T) &= \{M \in \text{mod}(A) \mid \text{Ext}_A^i(T, M) = 0 \text{ for all } 1 \leq i \leq n-1\} \\ &= \{M \in \text{mod}(A) \mid \text{Ext}_A^i(M, T) = 0 \text{ for all } 1 \leq i \leq n-1\}. \end{aligned}$$

For $n \geq 1$, A is **n -representation-finite** if $\text{gl. dim}(A) \leq n$ and if there exists an n -cluster-tilting module $T \in \text{mod}(A)$.

Proposition 4.35. *The following are equivalent:*

- (i) A is 1-representation-finite.
- (ii) A is representation-finite and $\text{gl. dim}(A) \leq 1$.

Proposition 4.36. *Assume that $\text{gl. dim}(A) \leq n$. Then the following are equivalent:*

- (i) A is n -representation-finite.
- (ii) For each indecomposable projective A -module P there exists some $i \geq 0$ such that $\nu_n^{-i}(P)$ is an indecomposable injective A -module.

In this case,

$$T := \bigoplus_{i \geq 0} \tau_n^{-i}({}_A A)$$

is an n -cluster-tilting module in $\text{mod}(A)$.

For $n \geq 1$, A is **weakly n -representation-finite** if there exists an n -cluster-tilting module $T \in \text{mod}(A)$.

4.9.3. n -representation-infinite algebras.

For $n \geq 1$, A is **n -representation-infinite** if $\text{gl. dim}(A) \leq n$ and if each $M \in \text{mod}(A)$ satisfies

$$\nu_n^{-i}(M) \in \text{mod}(A)$$

for all $i \geq 0$.

In this case, $\text{gl. dim}(A) = n$, since $\text{Ext}_A^n(D(A_A), {}_A A) = \nu_n^{-1}({}_A A) \neq 0$.

Proposition 4.37. *The following are equivalent:*

- (i) A is 1-representation-infinite.
- (ii) A is representation-infinite and $\text{gl. dim}(A) \leq 1$.

Example: For $n \geq 1$ let $A_n = KQ_n/I_n$ be the **Beilinson algebra** where Q_n is the quiver

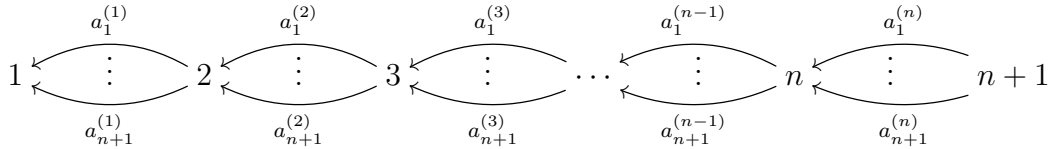

and I_n is generated by the relations

$$\{a_i^{(k)} a_j^{(k+1)} - a_j^{(k)} a_i^{(k+1)} \mid 1 \leq i, j \leq n+1, 1 \leq k \leq n-1\}.$$

(Note that A_1 is just the path algebra of the Kronecker quiver.) The algebra A_n is n -representation-infinite, see [HIO14, Example 2.15].

4.9.4. *n -hereditary algebras.* Assume that A is hereditary, i.e. $\text{gl. dim}(A) \leq 1$. Then we have

$$\text{ind}(\mathcal{D}^b(\text{mod}(A))) = \bigcup_{t \in \mathbb{Z}} (\text{ind}(A))[t].$$

For $n \geq 1$, let

$$\mathcal{D}^{n\mathbb{Z}}(\text{mod}(A)) := \{X \in \mathcal{D}^b(\text{mod}(A)) \mid H^i(X) = 0 \text{ for all } i \in \mathbb{Z} \setminus n\mathbb{Z}\}.$$

(For $n = 1$ we have $\mathcal{D}^{n\mathbb{Z}}(\text{mod}(A)) = \mathcal{D}^b(\text{mod}(A))$.)

For $\text{gl. dim}(A) \leq n$ we have

$$\text{ind}(\mathcal{D}^{n\mathbb{Z}}(\text{mod}(A))) = \bigcup_{t \in \mathbb{Z}} (\text{ind}(A))[tn].$$

A is **n -hereditary** if $\text{gl. dim}(A) \leq n$ and if

$$\nu_n^i({}_A A) \in \mathcal{D}^{n\mathbb{Z}}(\text{mod}(A))$$

for all $i \in \mathbb{Z}$.

Theorem 4.38 ([HIO14, Theorem 3.4]). *Assume that A is connected. Then the following are equivalent:*

- (i) A is n -hereditary.
- (ii) A is n -representation-finite or n -representation-infinite.

LITERATURE – n -REPRESENTATION-FINITE ALGEBRAS

- [HIO14] M. Herschend, O. Iyama, S. Oppermann, *n -representation infinite algebras*. Adv. Math. 252 (2014), 292–342.
- [HI11a] M. Herschend, O. Iyama, *Selfinjective quivers with potential and 2-representation-finite algebras*. Compos. Math. 147 (2011), no. 6, 1885–1920.
- [HI11b] M. Herschend, O. Iyama, *n -representation-finite algebras and twisted fractionally Calabi-Yau algebras*. Bull. Lond. Math. Soc. 43 (3) (2011), 449–466.
- [I11] O. Iyama, *Cluster tilting for higher Auslander algebras*. Adv. Math. 226 (1) (2011) 1–61.
- [IO11] O. Iyama, S. Oppermann, *n -representation-finite algebras and n -APR tilting*. Trans. Amer. Math. Soc. 363 (12) (2011), 6575–6614.
- [IO13] O. Iyama, S. Oppermann, *Stable categories of higher preprojective algebras*. Adv. Math. 244 (2013), 23–68.

[Back to Overview Tilted 4.](#)

4.10. **τ -tilting finite algebras.** Let A be a finite-dimensional algebra.

$X \in \text{mod}(A)$ is **τ -rigid** if $\text{Hom}_A(X, \tau_A(X)) = 0$.

A is **τ -tilting finite** if there are only finitely many indecomposable τ -rigid A -modules, up to isomorphism.

Theorem 4.39 ([DIJ19]). *The following are equivalent:*

- (i) A is τ -tilting finite.
- (ii) $\text{tors}(A) = \text{ff-tors}(A)$.
- (iii) $\text{torsfr}(A) = \text{ff-torsfr}(A)$.
- (iv) $\text{wide}(A) = \text{lf-wide}(A) = \text{rf-wide}(A)$.
- (v) $\text{brick}(A) = \text{lf-brick}(A) = \text{rf-brick}(A)$.
- (vi) $\text{tors}(A)$ is finite.
- (vii) $\text{torsfr}(A)$ is finite.
- (viii) $\text{wide}(A)$ is finite.
- (ix) $\text{brick}(A)$ is finite.

For the missing definitions and some more details we refer to Section 16.10.

$X \in \text{mod}(A)$ is a **brick** if $\text{End}_A(X)$ is a K -skew field.

A is **brick finite** if $\text{brick}(A)$ is finite.

Corollary 4.40. *The following are equivalent:*

- (i) A is τ -tilting finite;
- (ii) A is brick finite.

Examples:

- (i) Representation-finite algebras are τ -tilting finite.
- (ii) Let $A = \Pi(Q)$ be a preprojective algebra where Q is a Dynkin quiver. Then A is τ -tilting finite.

LITERATURE – τ -TILTING FINITE ALGEBRAS

[DIJ19] L. Demonet, O. Iyama, Osamu, G. Jasso, *τ -tilting finite algebras, bricks, and g -vectors*. Int. Math. Res. Not. IMRN 2019, no. 3, 852–892.

[Back to Overview Tilted 4.](#)

4.11. Fractionally Calabi-Yau algebras. Let A be a finite-dimensional K -algebra.

There is an embedding

$$\mathcal{K}^b(\text{proj}(A)) \rightarrow \mathcal{D}^b(\text{mod}(A))$$

of triangulated categories. This embedding is a triangle equivalence if and only if $\text{gl. dim}(A) < \infty$. The same holds for $\mathcal{K}^b(\text{inj}(A))$.

Recall that A is **Iwanaga-Gorenstein** if

$$\text{proj. dim}(D(A_A)) < \infty \quad \text{and} \quad \text{inj. dim}({}_A A) < \infty.$$

Considering $\mathcal{K}^b(\text{proj}(A))$ and $\mathcal{K}^b(\text{inj}(A))$ as subcategories of $\mathcal{D}^b(\text{mod}(A))$, Happel [H91] showed that for A Iwanaga-Gorenstein, we have

$$\mathcal{K}^b(\text{proj}(A)) = \mathcal{K}^b(\text{inj}(A)).$$

If A is Iwanaga-Gorenstein, then

$$\nu_A := D \circ \mathbf{R}\mathrm{Hom}_A(-, {}_A A) : \mathcal{K}^b(\mathrm{proj}(A)) \rightarrow \mathcal{K}^b(\mathrm{proj}(A))$$

is a Serre functor.

A is a **fractionally Calabi-Yau algebra** if the following hold:

- (i) A is Iwanaga-Gorenstein.
- (ii) There is a natural isomorphism

$$\nu_A^l \cong [m]$$

of endofunctors $\mathcal{K}^b(\mathrm{proj}(A)) \rightarrow \mathcal{K}^b(\mathrm{proj}(A))$ where m and l are integers with $l \neq 0$, $[-]$ is the shift functor and $[m] := [-]^m$.

In this case, A is an **(m, l) -Calabi-Yau algebra**. (The rational number m/l is uniquely determined by A .) One writes

$$\mathrm{CY}\text{-dim}(A) := (m, l)$$

if $l > 0$ is the smallest integer such that A is (m, l) -Calabi-Yau.

Note that an (m, l) -Calabi-Yau algebra is (km, kl) -Calabi-Yau for all $k \geq 1$. The converse is in general wrong.

Suppose that $\mathrm{gl.\dim}(A) < \infty$, and let Φ_A be the Coxeter matrix of A . If A is (m, l) -Calabi-Yau, then Φ_A^{2l} is the identity matrix, see [P14, Lemma 2.9].

A is a **twisted fractionally Calabi-Yau algebra** if the following hold:

- (i) A is Iwanaga-Gorenstein.
- (ii) There is a natural isomorphism

$$\nu_A^l \cong [m] \circ \sigma^*$$

of endofunctors $\mathcal{K}^b(\mathrm{proj}(A)) \rightarrow \mathcal{K}^b(\mathrm{proj}(A))$ where m and l are integers with $l \neq 0$ and $\sigma : A \rightarrow A$ is a K -algebra automorphism.

In this case, A is a **twisted (m, l) -Calabi-Yau algebra**.

Here σ^* denotes the endofunctor

$$\sigma^* := {}_{\sigma}A_1 \overset{\mathbf{L}}{\otimes}_A - : \mathcal{K}^b(\mathrm{proj}(A)) \rightarrow \mathcal{K}^b(\mathrm{proj}(A))$$

where ${}_{\sigma}A_1$ is the A - A -bimodule defined by $axb := \sigma(a)xb$ for $a, b, x \in A$.

Obviously, fractionally Calabi-Yau algebras are twisted fractionally Calabi-Yau.

Examples:

- (i) A is $(0, 1)$ -Calabi-Yau if and only if A is symmetric.
- (ii) If A is selfinjective, then A is twisted $(0, 1)$ -Calabi-Yau.

- (iii) Let Q be an acyclic quiver, and let $A = KQ$. Then Q is fractionally Calabi-Yau if and only if Q is a Dynkin quiver. In this case, let h be the Coxeter number of Q . We have

$$\text{CY-dim}(A) = \begin{cases} \left(\frac{h}{2} - 1, \frac{h}{2}\right) & \text{if } Q \text{ is of type } A_1, D_{2n}, E_7 \text{ or } E_8, \\ (h - 2, h) & \text{otherwise,} \end{cases}$$

see [HI11, Section 3.1]. Here are the Coxeter numbers of the Dynkin quivers:

Q	A_n	D_n	E_6	E_7	E_8
h	$n + 1$	$2(n - 1)$	12	18	30

Theorem 4.41 (Chan, Darpö, Iyama, Marczinzik [CDIM20, Theorem 1.2]). *Assume that $A/J(A)$ is a separable K -algebra. The following are equivalent:*

- (i) $T(A)$ is periodic.
- (ii) $\text{gl. dim}(A) < \infty$ and A is fractionally Calabi-Yau.

Theorem 4.42 ([CDIM20, Theorem 1.3]). *Assume that $A/J(A)$ is a separable K -algebra. The following are equivalent:*

- (i) $T(A)$ is twisted periodic.
- (ii) $\text{gl. dim}(A) < \infty$ and A is twisted fractionally Calabi-Yau.

Conjecture 4.43 (Periodicity Conjecture [CDIM20, Question 1.4]). *Assume that $\text{gl. dim}(A) < \infty$. If A is twisted fractionally Calabi-Yau, then A is fractionally Calabi-Yau.*

There are examples of twisted fractionally Calabi-Yau algebras with infinite global dimension which are not fractionally Calabi-Yau.

Theorem 4.44 (Herschend, Iyama [HI11, Theorem 1.1]). *If A is connected and n -representation-finite, then A is twisted fractionally Calabi-Yau.*

Theorem 4.45 ([HI11, Remark 1.6]). *The class of fractionally Calabi-Yau K -algebras is closed under derived equivalence.*

Example: Let $A = KQ/I$ where Q is the quiver

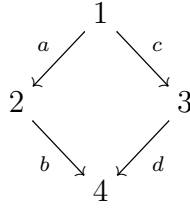

and I is generated by $ba - dc$. Then A is fractionally Calabi-Yau, but there is no n such that A is n -representation-finite. The algebra A is derived equivalent to the path algebra of the quiver

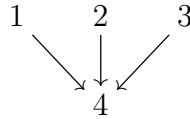

which is 1-representation-finite. Thus being n -representation-finite for some $n \geq 1$ is not preserved under derived equivalence. This example is taken from [HI11, Remark 1.6(a)].

Theorem 4.46 ([CDIM20, Corollary 1.8]). *Let K be a perfect field. Then the class of twisted fractionally Calabi-Yau K -algebras of finite global dimension is closed under derived equivalence.*

The class of twisted fractionally Calabi-Yau K -algebras of infinite global dimension not closed under derived equivalence.

LITERATURE – FRACTIONALLY CALABI-YAU ALGEBRAS

- [CDIM20] A. Chan, E. Darpö, O. Iyama, R. Marczinzik, *Periodic trivial extension algebras and fractionally Calabi-Yau algebras*. Preprint (2020), 33pp., arXiv:2012.11927
- [H91] D. Happel, *On Gorenstein algebras*. Representation theory of finite groups and finite-dimensional algebras (Bielefeld, 1991), 389–404, Progr. Math., 95, Birkhuser, Basel, 1991.
- [HI11] M. Herschend, O. Iyama, *n -representation-finite algebras and twisted fractionally Calabi-Yau algebras*. Bull. Lond. Math. Soc. 43 (2011), no. 3, 449–466.
- [MY01] J. Miyachi, A. Yekutieli, *Derived Picard groups of finite-dimensional hereditary algebras*. Compositio Math. 129 (2001), no. 3, 341–368.
- [P14] J.A. de la Peña, *Algebras whose Coxeter polynomials are products of cyclotomic polynomials*. Algebr. Represent. Theory 17 (2014), no. 3, 905–930.
- [vR12] A.-C. van Roosmalen, *Abelian hereditary fractionally Calabi-Yau categories*. Int. Math. Res. Not. IMRN 2012, no. 12, 2708–2750.

[Back to Overview Tilted 4.](#)

4.12. Calabi-Yau categories. Let \mathcal{C} be a Hom-finite K -linear category. As usual let $D := \text{Hom}_K(-, K)$.

A **Serre functor** for \mathcal{C} is an equivalence

$$S: \mathcal{C} \rightarrow \mathcal{C}$$

such that there are functorial isomorphisms

$$\mathrm{Hom}_{\mathcal{C}}(X, S(Y)) \cong D \mathrm{Hom}_{\mathcal{C}}(Y, X)$$

for all $X, Y \in \mathcal{C}$.

Suppose that \mathcal{C} is a Hom-finite K -linear triangulated category. If there is a Serre functor S for \mathcal{C} , then S is a triangle equivalence and it is unique up to unique isomorphism.

Let \mathcal{C} be an idempotent complete Hom-finite K -linear triangulated category, and let $n \geq 1$. Then \mathcal{C} is an **n -Calabi-Yau category** if there are functorial isomorphisms

$$\mathrm{Hom}_{\mathcal{C}}(X, Y[n]) \cong D \mathrm{Hom}_{\mathcal{C}}(Y, X)$$

for all $X, Y \in \mathcal{C}$. In other words, $[n]$ is a Serre functor for \mathcal{C} .

Note that the conditions idempotent complete and Hom-finite ensure that \mathcal{C} is a Krull-Remak-Schmidt category, i.e. each object is a finite direct sum of objects with local endomorphism rings and therefore the Krull-Remak-Schmidt Theorem holds in \mathcal{C} .

The definition above is commonly used amongst mathematicians working on the representation theory of finite-dimensional algebras. However this is not standard. Keller [K08] uses the term *weakly n -Calabi-Yau* instead of *n -Calabi-Yau* and he is not insisting on idempotent completeness. The standard definition of an *n -Calabi-Yau category* is more involved, see e.g. [K08].

For $i \geq 0$ one often writes $\mathrm{Ext}_{\mathcal{C}}^i(X, Y)$ instead of $\mathrm{Hom}_{\mathcal{C}}(X, Y[i])$.

Lemma 4.47. *For an n -Calabi-Yau category \mathcal{C} there are functorial isomorphisms*

$$\mathrm{Ext}_{\mathcal{C}}^{n-i}(X, Y) \cong D \mathrm{Ext}_{\mathcal{C}}^i(Y, X)$$

for all $X, Y \in \mathcal{C}$ and $0 \leq k \leq n$.

In particular, for a 2-Calabi-Yau category \mathcal{C} we have functorial isomorphisms

$$\mathrm{Ext}_{\mathcal{C}}^1(X, Y) \cong D \mathrm{Ext}_{\mathcal{C}}^1(Y, X)$$

for all $X, Y \in \mathcal{C}$.

4.13. Calabi-Yau tilted algebras.

Let \mathcal{C} be an n -Calabi-Yau category. An object $T \in \mathcal{C}$ is an **n -cluster-tilting object** if

$$\begin{aligned} \text{add}(T) &= \{X \in \mathcal{C} \mid \text{Ext}_{\mathcal{C}}^i(T, X) = 0 \text{ for } 1 \leq i \leq n-1\} \\ &= \{X \in \mathcal{C} \mid \text{Ext}_{\mathcal{C}}^i(X, T) = 0 \text{ for } 1 \leq i \leq n-1\}. \end{aligned}$$

By Lemma 4.47 the second equality in the definition above is redundant.

Let T be an n -cluster-tilting object in an n -Calabi-Yau category \mathcal{C} . Then

$$B := \text{End}_{\mathcal{C}}(T)^{\text{op}}$$

is an **n -Calabi-Yau tilted algebra**.

Recall that for a finite-dimensional algebra A , $\text{cogen}({}_A A)$ is the subcategory of all $M \in \text{mod}(A)$ such that M is isomorphic to a submodule of ${}_A A^m$ for some m . If A is 1-Iwanaga-Gorenstein, then $\text{cogen}({}_A A) = \text{gp}(A)$ is the Frobenius category of Gorenstein-projective A -modules. In particular, its stable category is a triangulated category.

Theorem 4.48 (Keller, Reiten [KR07]). *For a 2-Calabi-Yau tilted algebra A the following hold:*

- (i) A is a 1-Iwanaga-Gorenstein algebra.
- (ii) $\text{gl. dim}(A) \leq 1$ or $\text{gl. dim}(A) = \infty$.
- (iii) $\text{gp}(A)$ is a 3-Calabi-Yau category.

Theorem 4.49 (Keller, Reiten [KR07]). *Let \mathcal{C} be 2-Calabi-Yau category, and let T be a 2-cluster-tilting object in \mathcal{C} . Then*

$$\text{Hom}_{\mathcal{C}}(T, -): \mathcal{C} / \text{add}(T[1]) \rightarrow \text{mod}(\text{End}_{\mathcal{C}}(T)^{\text{op}})$$

is an equivalence of categories.

It is not known in general if the 2-Calabi-Yau tilted algebra $\text{End}_{\mathcal{C}}(T)^{\text{op}}$ determines \mathcal{C} , see [KR08] for some partial results.

Let \mathcal{C} be 2-Calabi-Yau category, and let T be a 2-cluster-tilting object in \mathcal{C} . We assume that $T = T_1 \oplus \cdots \oplus T_n$ with T_i indecomposable and $T_i \not\cong T_j$ for all $i \neq j$. Set $B := \text{End}_{\mathcal{C}}(T)^{\text{op}}$. Assume also that the quiver of B has no loops.

Using the same arguments as in [BMRRT06] one gets that for each $1 \leq k \leq n$ there exists a unique indecomposable object $T'_k \in \mathcal{C}$ such that $T'_k \not\cong T_k$ and

$$\mu_k(T) := T' := T'_k \oplus T/T_k$$

is a 2-cluster tilting object. Define $B' := \text{End}_{\mathcal{C}}(T')^{\text{op}}$. Let S_k be the simple top of the indecomposable projective B -module $\text{Hom}_{\mathcal{C}}(T, T_k)$, and let S'_k be the simple top of the indecomposable projective B' -module $\text{Hom}_{\mathcal{C}}(T', T'_k)$.

The following result can be interpreted as a spectacular generalization of the results in [APR79].

Theorem 4.50 ([BMR07, KR07]). *There is an equivalence of K -linear categories*

$$\text{mod}(B)/\text{add}(S_k) \rightarrow \text{mod}(B')/\text{add}(S'_k).$$

For further reading on 2-Calabi-Yau tilted algebras we refer to [K08] and [R10].

We focus now on a special class of 2-Calabi-Yau tilted algebras.

Let Q be an acyclic quiver, and let

$$\mathcal{C}_Q := \mathcal{D}^b(\text{mod}(KQ))/\tau^{-1}[1]$$

be the **cluster category** associated with Q .

Cluster categories were defined in [BMRRT06].

Keller [K05] proved that \mathcal{C}_Q is a triangulated category with all morphism spaces finite-dimensional. Based on this, it is straightforward to check that \mathcal{C}_Q is a 2-Calabi-Yau category.

A finite-dimensional K -algebra A is a **cluster-tilted algebra** if

$$A \cong \text{End}_{\mathcal{C}_Q}(T)^{\text{op}}$$

for some cluster-tilting object $T \in \mathcal{C}_Q$.

Obviously, cluster-tilted algebras are 2-Calabi-Yau tilted algebras.

Cluster tilted algebras have been introduced and studied in [BMR07].

Recall that a Hom-finite K -linear triangulated category \mathcal{C} is **algebraic** if there exists a Frobenius category \mathcal{F} and a triangle equivalence

$$\mathcal{C} \rightarrow \underline{\mathcal{F}}.$$

(Here $\underline{\mathcal{F}}$ denote the stable category of \mathcal{F} .)

Theorem 4.51 (Keller, Reiten [KR08]). *Let K be algebraically closed. Let \mathcal{C} be an algebraic 2-Calabi-Yau category. Assume that there exists a 2-cluster-tilting object $T \in \mathcal{C}$ such that the quiver Q of $B := \text{End}_{\mathcal{C}}(T)^{\text{op}}$ is acyclic. Then there is a triangle equivalence*

$$\mathcal{C} \rightarrow \mathcal{C}_Q.$$

Example: Let $A = KQ$ where Q is the quiver

$$1 \longleftarrow 2 \longleftarrow 3$$

The Auslander-Reiten quiver Γ_A is

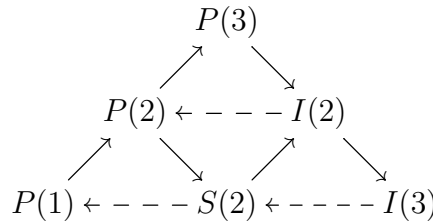

The Auslander-Reiten quiver of the derived category $\mathcal{D}^b(\text{mod}(A))$ is

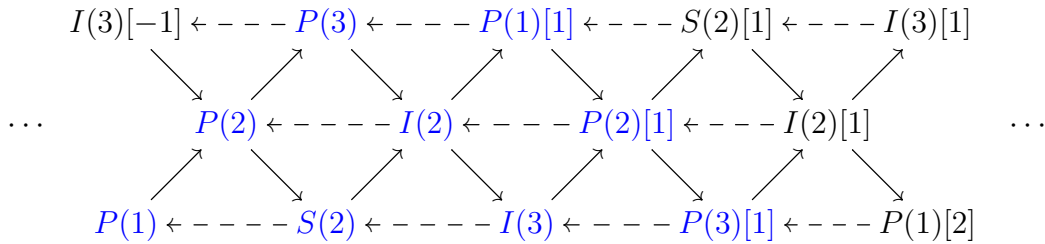

We have $\mathcal{C}_Q = \mathcal{D}^b(\text{mod}(A))/\tau^{-1}[1]$. The objects marked in blue yield a complete set of representatives of isomorphism classes of indecomposable objects in \mathcal{C}_Q . The object

$$T := P(1) \oplus P(3) \oplus I(3)$$

is a 2-cluster-tilting object in \mathcal{C}_Q . The endomorphism algebra $B = \text{End}_{\mathcal{C}_Q}(T)^{\text{op}}$ is isomorphic to KQ/I where Q is the quiver

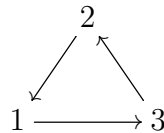

and I is generated by all paths of length 2.

LITERATURE – CALABI-YAU TILTED ALGEBRAS

[APR79] M. Auslander, M. Platzeck, I. Reiten, *Coxeter functors without diagrams*. Trans. Amer. Math. Soc. 250 (1979), 1–46.
 [BMRRT06] A. Buan, R. Marsh, M. Reineke, I. Reiten, G. Todorov, *Tilting theory and cluster combinatorics*, Adv. Math. 204 (2006), no. 2, 572–618.
 [BMR07] A. Buan, R. Marsh, I. Reiten, *Cluster-tilted algebras*, Trans. Amer. Math. Soc. 359 (2007), no. 1, 323–332.

- [KR07] B. Keller, I. Reiten, *Cluster-tilted algebras are Gorenstein and stably Calabi-Yau*, Adv. Math. 211 (2007), 123–151.
- [KR08] B. Keller, I. Reiten, *Acyclic Calabi-Yau categories*. With an appendix by Michel Van den Bergh. Compos. Math. 144 (2008), no. 5, 1332–1348.
- [K08] B. Keller, *Calabi-Yau triangulated categories*. Trends in representation theory of algebras and related topics, 467–489, EMS Ser. Congr. Rep., Eur. Math. Soc., Zürich, 2008.
- [K05] B. Keller, *On triangulated orbit categories*. Doc. Math. 10 (2005), 551–581.
- [R10] I. Reiten, *2-Calabi-Yau tilted algebras*, São Paulo J. Math. Sci. 4 (2010), no. 3, 529–545.

Back to Overview Tilted 4.

4.14. Jacobian algebras.

4.14.1. *Completed path algebras*. Let Q be a quiver. The path algebra of Q is denoted by KQ . Let $K\langle\langle Q \rangle\rangle$ be the **completed path algebra** of Q . As a \mathbb{C} -vector space we have

$$K\langle\langle Q \rangle\rangle = \prod_{m \geq 0} KQ_m$$

where KQ_m is a K -vector space with a basis labeled by the paths of length m in Q . The multiplication of KQ and $K\langle\langle Q \rangle\rangle$ is induced by the concatenation of paths. Both algebras are naturally graded by the length of paths.

Let

$$\mathfrak{m} := \prod_{m \geq 1} KQ_m$$

be the **arrow ideal** of $K\langle\langle Q \rangle\rangle$. For any subset $U \subseteq K\langle\langle Q \rangle\rangle$ let

$$\bar{U} := \bigcap_{p \geq 0} (U + \mathfrak{m}^p)$$

be the **\mathfrak{m} -adic closure** of U .

Let $A = K\langle\langle Q \rangle\rangle/I$ where I is an ideal in $K\langle\langle Q \rangle\rangle$. Let

$$\bar{A} := K\langle\langle Q \rangle\rangle/\bar{I}$$

and for $p \geq 2$ let

$$A_p := K\langle\langle Q \rangle\rangle/(I + \mathfrak{m}^p)$$

be the **p -truncation** of A . The algebras A_p are finite-dimensional K -algebras, and we get a chain

$$\cdots \rightarrow A_p \rightarrow \cdots \rightarrow A_3 \rightarrow A_2$$

of surjective K -algebra homomorphisms. This yields a chain

$$\text{mod}(A_2) \rightarrow \text{mod}(A_3) \rightarrow \cdots \rightarrow \text{mod}(A_p) \rightarrow \cdots$$

of embeddings.

Proposition 4.52. *We have*

$$\text{mod}(A) = \text{mod}(\bar{A}) = \bigcup_{p \geq 2} \text{mod}(A_p).$$

Note that

$$\bar{A} = \varprojlim(A_p),$$

i.e. \bar{A} is the inverse limit of the algebras A_p .

If we assume additionally that $I \subseteq \mathfrak{m}^2$, then A_p is a basic K -algebra for all p .

4.14.2. *Jacobian algebras.* Let Q be a quiver. A path $a_1 \cdots a_m$ of length $m \geq 1$ in Q is a **cycle** or more precisely an **m -cycle** if $s(a_m) = t(a_1)$. Quivers without cycles are called **acyclic**. A quiver is **2-acyclic** if it does not contain any 2-cycles.

An element $S \in K\langle\langle Q \rangle\rangle$ is a **potential** for Q if S is a (possibly infinite) linear combination of cycles in Q . The pair (Q, S) is called a **quiver with potential**. It is **2-acyclic** if Q is 2-acyclic.

We recall Derksen, Weyman and Zelevinsky's [DWZ08] definition of the *Jacobian algebra* $\mathcal{P}(Q, S)$. For a cycle $a_1 \cdots a_m$ in Q and an arrow $a \in Q_1$ define

$$\partial_a(a_1 \cdots a_m) := \sum_{\substack{1 \leq p \leq m \\ a_p = a}} a_{p+1} \cdots a_m a_1 \cdots a_{p-1}.$$

We extend this linearly and obtain the **cyclic derivative** $\partial_a(S)$ of a potential S for Q . Let

$$\partial(S) := \{\partial_a(S) \mid a \in Q_1\}.$$

Let $I(S)$ be the ideal in $K\langle\langle Q \rangle\rangle$ generated by $\partial(S)$.

Let

$$\mathcal{P}(Q, S) := K\langle\langle Q \rangle\rangle / \overline{I(S)}$$

be the **Jacobian algebra** associated with (Q, S) .

Jacobian algebras play a central role in the categorification of Fomin-Zelevinsky cluster algebras. For the definition of cluster algebras we refer to [FZ02]. Jacobian algebras also appear in mathematical physics, see for example [C13].

One often focusses on Jacobian algebras $\mathcal{P}(Q, S)$ where Q is a 2-acyclic quiver and S is a non-degenerate potential.

Examples:

(i) Let Q be the quiver

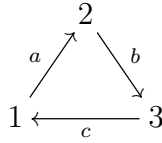

and let $S = cba$. It follows that $\mathcal{P}(Q, S) = KQ/I$ where I is generated by all paths of length 2.

(ii) Let Q be an acyclic quiver. Then $S = 0$ is the only potential for Q , and we have $\mathcal{P}(Q, S) = KQ$.

Theorem 4.53 (Amiot [A09]). *Suppose that $\mathcal{P}(Q, S)$ is finite-dimensional. Then $\mathcal{P}(Q, S)$ is a 2-Calabi-Yau tilted algebra.*

There are many examples of 2-Calabi-Yau categories \mathcal{C} such that all 2-Calabi-Yau tilted algebras arising from \mathcal{C} are Jacobian algebras.

4.14.3. *Mutations of quivers.* The following combinatorial definition is due to Fomin and Zelevinsky [FZ02]. It is a crucial ingredient for their definition of cluster algebras.

Let Q be a 2-acyclic quiver, and let $k \in Q_0$. The **mutation of Q at k** is a quiver $\mu_k(Q)$ which is obtained from Q in three steps:

(i) For each path ba of length 2 in Q with $s(b) = t(a) = k$, add a new arrow $[ba]$ with $s([ba]) = t(b)$ and $t([ba]) := s(a)$.

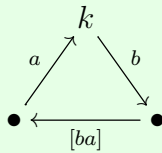

(ii) Reverse each arrow incident to k .

(iii) Choose a 2-cycle cd and then remove the arrows c and d . Repeat this until there are no 2-cycles left.

Note that $\mu_k(\mu_k(Q)) = Q$ for all k .

The mutation operation yields an equivalence relations on the set of all 2-acyclic quivers.

A 2-acyclic quiver Q is of **finite mutation type** if there are only finitely many quivers mutation equivalent to Q . Otherwise, Q is of **infinite mutation type**.

Example:

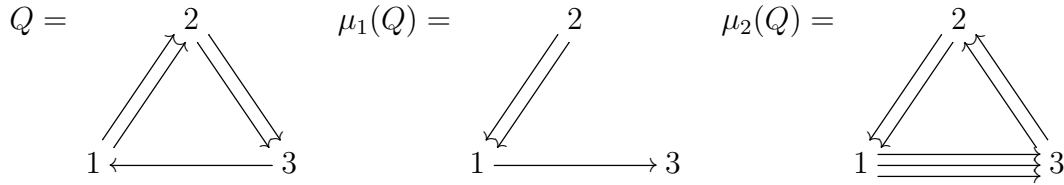

The quiver Q is of infinite mutation type.

There is a beautiful combinatorial classification of quivers of finite mutations type by Felikson, Shapiro and Tumarkin [FST12]. Their classification is inspired by some groundbreaking work by Fomin, Shapiro and Thurston [FST08].

4.14.4. *Non-degenerate potentials.* Let $K = \mathbb{C}$. Let Q be 2-acyclic, and let S be a potential for Q . For $k \in Q_0$, Derksen, Weyman and Zelevinsky [DWZ08, DWZ10] defined a Jacobian algebra $\mathcal{P}(\mu_k(Q, S))$ where $(Q', S') := \mu_k(Q, S)$ is again a quiver with potential. We do not repeat here the rather technical definition of $\mu_k(Q, S)$. It can happen that Q' contains 2-cycles.

The potential S is **non-degenerate** provided for all sequences (k_1, \dots, k_t) of vertices and

$$(Q', S') := \mu_{k_t} \cdots \mu_{k_1}(Q, S),$$

the quiver Q' is 2-acyclic. In this case, we have

$$Q' = \mu_{k_t} \cdots \mu_{k_1}(Q).$$

Theorem 4.54 (Derksen, Weyman and Zelevinsky [DWZ08]). *For each 2-acyclic quiver there exists a non-degenerate potential.*

The proof of this theorem is not constructive, i.e. for a given 2-acyclic quiver Q it can be difficult to write down explicitly a non-degenerate potential for Q . By work of Labardini-Fragoso [LF09, LF10] this problem has been solved for most quivers Q of finite mutation type.

Question 4.55. *Let Q be a 2-acyclic quiver. Is there always a non-degenerate potential S for Q such that*

$$\dim \mathcal{P}(Q, S) < \infty?$$

Theorem 4.56 (Derksen, Weyman, Zelevinsky [DWZ08, DWZ10]). *Let Q be a 2-acyclic quiver, and let S be a non-degenerate potential for Q . Then the Fomin-Zelevinsky cluster algebra $\mathcal{A}(Q)$ can be categorified via $\mathcal{P}(Q, S)$.*

4.14.5. *Nearly Morita equivalence.* Also in this section, let $K = \mathbb{C}$.

For a K -algebra A and $M \in \text{mod}(A)$ the M -stable category

$$\text{mod}(A)/\text{add}(M)$$

has by definition the same objects as $\text{mod}(A)$, and the morphism spaces are the morphism spaces from $\text{mod}(A)$ modulo the subspaces of morphism factoring through some object in $\text{add}(M)$.

Theorem 4.57 (Buan, Iyama, Reiten, Smith [BIRS11]). *Let S be a potential for a 2-acyclic quiver Q , and let $(Q', S') := \mu_k(Q, S)$. There is an equivalence of additive categories*

$$\text{mod}(\mathcal{P}(Q, S))/\text{add}(S(k)) \rightarrow \text{mod}(\mathcal{P}(Q', S'))/\text{add}(S(k)).$$

The following statement may not come as a surprise, but the proof is not so straightforward.

Theorem 4.58 ([GLS16]). *Let S be a potential for a 2-acyclic quiver Q , and let $(Q', S') := \mu_k(Q, S)$. Then $\mathcal{P}(Q, S)$ and $\mathcal{P}(Q', S')$ have the same representation type.*

Krause [K97] proved that stable equivalences of dualizing algebras preserve the representation type. At least for finite-dimensional Jacobian algebras, this leads to another proof of the theorem above.

4.14.6. *Tame-wild classification of Jacobian algebras.* Also in this section, let $K = \mathbb{C}$.

A 2-acyclic quiver Q is of **finite cluster type** if the Fomin-Zelevinsky cluster algebra $\mathcal{A}(Q)$ has only finitely many cluster variables.

The following spectacular result yields new symmetries on the root systems of finite-dimensional complex Lie algebras over \mathbb{C} .

Theorem 4.59 (Fomin and Zelevinsky [FZ03]). *Q is of finite cluster type if and only if Q is mutation equivalent to a Dynkin quiver.*

Combining this with Derksen, Weyman and Zelevinsky's results one gets the following:

Theorem 4.60. For a 2-acyclic quiver Q and a non-degenerate potential S for Q the following are equivalent:

- (i) Q is of finite cluster type.
- (ii) Q is mutation equivalent to a Dynkin quiver.
- (iii) $\mathcal{P}(Q, S)$ is representation-finite.

We call a 2-acyclic quiver Q **Jacobi-tame** (resp. **Jacobi-wild**) if for all non-degenerate potentials S the Jacobian algebra $\mathcal{P}(Q, S)$ is tame (resp. wild). Otherwise, we call Q **Jacobi-irregular**.

We need the following list of exceptional 2-acyclic quivers of finite mutation type:

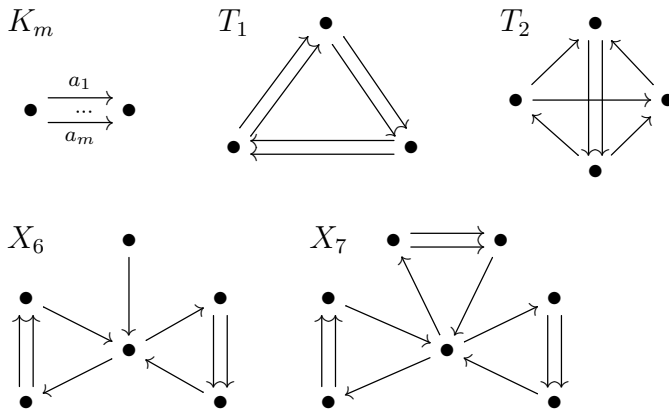

Theorem 4.61 ([GLS16]). Let Q be a 2-acyclic quiver. If Q is not mutation equivalent to one of the quivers T_1, T_2, X_6, X_7 or K_m with $m \geq 3$, then the following hold:

- (i) Q is Jacobi-tame if and only if Q is of finite mutation type.
- (ii) Q is Jacobi-wild if and only if Q is of infinite mutation type.

For the exceptional cases the following hold:

- (iii) If Q is mutation equivalent to one of the quivers X_6, X_7 or K_m with $m \geq 3$, then Q is Jacobi-wild.
- (iv) If Q is mutation equivalent to one of the quivers T_1 or T_2 , then Q is Jacobi-irregular.

For most quivers of finite mutation type there exists exactly one non-degenerate potential up to weak right equivalence, compare [GLS16].

Example: We discuss one of the exceptional cases. Let $Q := T_1$ be the quiver

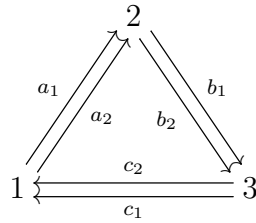

We consider the potentials

$$\begin{aligned} S_1 &:= c_1 b_1 a_1 + c_2 b_2 a_2, \\ S_2 &:= c_1 b_1 a_1 + c_2 b_2 a_2 + a_1 b_2 c_1 a_2 b_1 c_2, \\ S_3 &:= c_2 b_2 a_1 + c_2 b_1 a_2 + c_1 b_2 a_2. \end{aligned}$$

All three potentials are non-degenerate.

- (1) The ideal $I(S_1)$ is generated by

$$\{b_1 a_1, c_1 b_1, a_1 c_1, b_2 a_2, c_2 b_2, a_2 c_2\}.$$

We get $\overline{I(S_1)} = I(S_1)$. Thus $\mathcal{P}(Q, S_1)$ is an infinite-dimensional gentle algebra. In particular, $\mathcal{P}(Q, S_1)$ is tame.

- (2) The ideal $I(S_2)$ is generated by

$$\{b_1 a_1 + a_2 b_1 c_2 a_1 b_2, c_1 b_1 + b_2 c_1 a_2 b_1 c_2, a_1 c_1 + c_2 a_1 b_2 c_1 a_2, \\ b_2 a_2 + a_1 b_2 c_1 a_2 b_1, c_2 b_2 + b_1 c_2 a_1 b_2 c_1, a_2 c_2 + c_1 a_2 b_1 c_2 a_1\}.$$

The algebra $K\langle\langle Q \rangle\rangle/I(S_2)$ is infinite-dimensional, whereas the Jacobian algebra $\mathcal{P}(Q, S_2) = K\langle\langle Q \rangle\rangle/\overline{I(S_2)}$ is finite-dimensional. The algebra $\mathcal{P}(Q, S_2)$ is also tame.

- (3) The ideal $I(S_3)$ is generated by

$$\{c_1 b_2, a_2 c_2, b_2 a_2, c_2 b_1 + c_1 b_2, a_1 c_2 + a_2 c_1, b_2 a_1 + b_1 a_2\}.$$

The algebra $\mathcal{P}(Q, S_3)$ is wild.

LITERATURE – JACOBIAN ALGEBRAS

- [A09] C. Amiot, *Cluster categories for algebras of global dimension 2 and quivers with potential*. Ann. Inst. Fourier (Grenoble) 59 (2009), no. 6, 2525–2590.
- [BIRS11] A. Buan, O. Iyama, I. Reiten, D. Smith, *Mutation of cluster-tilting objects and potentials*. Amer. J. Math. 133 (2011), no. 4, 835–887.
- [C13] S. Cecotti, *Categorical tinkertoys for $N = 2$ gauge theories*. Internat. J. Modern Phys. A 28 (2013), no. 5–6, 1330006, 124 pp.
- [DWZ08] H. Derksen, J. Weyman and A. Zelevinsky, *Quivers with potentials and their representations I: Mutations*. Selecta Math. (N.S.) 14 (2008), no. 1, 59–119.
- [DWZ10] H. Derksen, J. Weyman and A. Zelevinsky, *Quivers with potentials and their representations II: applications to cluster algebras*. J. Amer. Math. Soc. 23 (2010), no. 3, 749–790.
- [FST12] A. Felikson, M. Shapiro, P. Tumarkin, *Skew-symmetric cluster algebras of finite mutation type*. J. Eur. Math. Soc. (JEMS) 14 (2012), no. 4, 1135–1180.
- [FST08] S. Fomin, M. Shapiro, D. Thurston, *Cluster algebras and triangulated surfaces. I. Cluster complexes*. Acta Math. 201 (2008), no. 1, 83–146.

- [FZ02] S. Fomin, A. Zelevinsky, *Cluster algebras. I. Foundations*. J. Amer. Math. Soc. 15 (2002), no. 2, 497–529.
- [FZ03] S. Fomin, A. Zelevinsky, *Cluster algebras. II. Finite type classification*. Invent. Math. 154 (2003), no. 1, 63–121.
- [GLS16] C. Geiß, D. Labardini-Fragoso, J. Schröer. *The representation type of Jacobian algebras*. Adv. Math. 290 (2016), 364–452.
- [KR07] B. Keller, I. Reiten, *Cluster-tilted algebras are Gorenstein and stably Calabi-Yau*. Adv. Math. 211 (2007), no. 1, 123–151.
- [KR08] B. Keller, I. Reiten, *Acyclic Calabi-Yau categories*. With an appendix by Michel Van den Bergh. Compos. Math. 144 (2008), no. 5, 1332–1348.
- [K08] B. Keller, *Calabi-Yau triangulated categories*. Trends in representation theory of algebras and related topics, 467–489, EMS Ser. Congr. Rep., Eur. Math. Soc., Zürich, 2008.
- [K97] H. Krause, *Stable equivalence preserves representation type*. Comment. Math. Helv. 72 (1997), no. 2, 266–284.
- [LF09] D. Labardini-Fragoso, *Quivers with potentials associated to triangulated surfaces*. Proc. Lond. Math. Soc. (3) 98 (2009) 797–839.
- [LF10] D. Labardini-Fragoso, *Quivers with potentials associated with triangulations of Riemann surfaces*. Ph.D. thesis, Northeastern University, 2010.

[Back to Overview Tilted 4.](#)

5. Selfinjective algebras

§5 Selfinjective algebras:

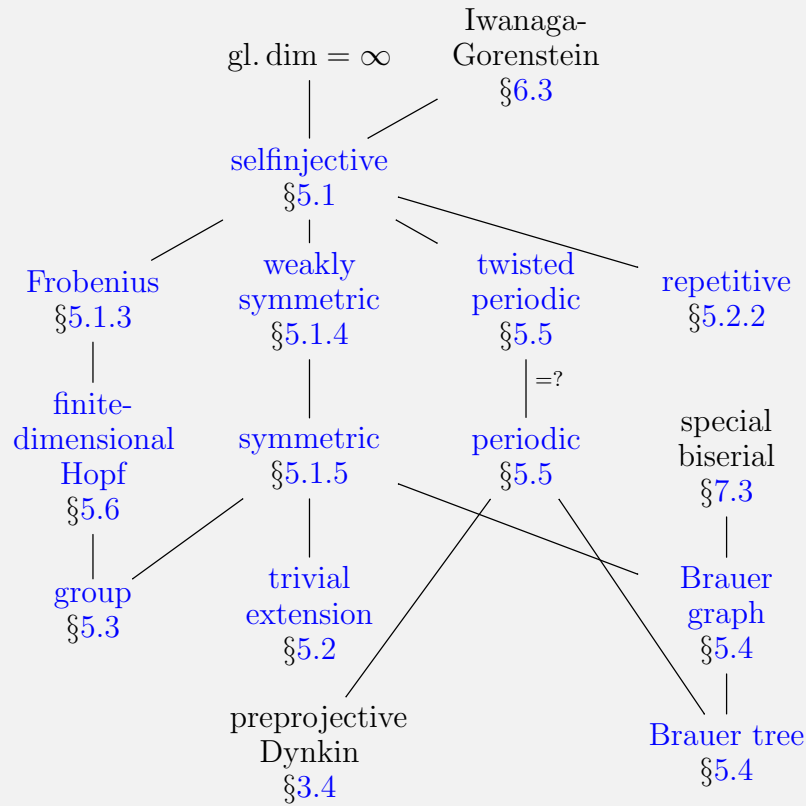

[Back to Overview Metaclasses 1.](#)

5.1. Selfinjective algebras.

5.1.1. *Two important bimodules.* Let A be a K -algebra. Then A is an A - A -bimodule in the obvious way. The K -dual

$$D(A) := \text{Hom}_K(A, K)$$

is also an A - A -bimodule via

$$\begin{aligned} A \times D(A) &\rightarrow D(A) & D(A) \times A &\rightarrow D(A) \\ (a, f) &\mapsto [af : b \mapsto f(ba)] & (f, a) &\mapsto [fa : b \mapsto f(ab)]. \end{aligned}$$

5.1.2. *Selfinjective algebras.*

A K -algebra A is **selfinjective** if ${}_A A$ is injective.

Proposition 5.1. *For a finite-dimensional K -algebra A the following are equivalent:*

- (i) A is selfinjective;
- (ii) A_A is injective;
- (iii) $\text{proj}(A) = \text{inj}(A)$;
- (iv) $\text{Proj}(A) = \text{Inj}(A)$.

Examples:

- Semisimple algebras are selfinjective.
- The truncated polynomial ring $A = K[T]/(T^n)$ is selfinjective for all $n \geq 1$.
- Let $A = KQ/I$ where Q is the quiver

$$1 \begin{array}{c} \xrightarrow{a} \\ \xleftarrow{b} \end{array} 2$$

and I is generated by $\{ab, ba\}$. We have

$$P(1) = I(2) = \begin{pmatrix} 1 \\ 2 \end{pmatrix} \quad \text{and} \quad P(2) = I(1) = \begin{pmatrix} 2 \\ 1 \end{pmatrix}.$$

Thus A is selfinjective.

Proposition 5.2. *Let A be a finite-dimensional selfinjective K -algebra. Then for $M \in \text{Mod}(A)$ the following are equivalent:*

- (i) $\text{proj. dim}(M) = \infty$;
- (ii) M is non-projective.

Corollary 5.3. *For a finite-dimensional selfinjective K -algebra A we have*

$$\text{gl. dim}(A) = \begin{cases} 0 & \text{if } A \text{ is semisimple,} \\ \infty & \text{otherwise.} \end{cases}$$

Selfinjective algebras appear in numerous different contexts and disguises. Some of these are mentioned below.

5.1.3. *Frobenius algebras.*

A finite-dimensional K -algebra A is a **Frobenius algebra** if there exists a non-degenerate K -bilinear form

$$(-, ?): A \times A \rightarrow K$$

such that $(ab, c) = (a, bc)$ for all $a, b, c \in A$.

Theorem 5.4 (Brauer, Nesbitt, Nakayama (1937-1939)). *For a finite-dimensional K -algebra the following are equivalent:*

(i) A is a Frobenius algebra.

(ii) There exists an isomorphism

$${}_A A \rightarrow {}_A D(A)$$

of left A -modules.

(iii) There exists an isomorphism

$$A_A \rightarrow D(A)_A$$

of left A -modules.

Corollary 5.5. *Frobenius algebras are selfinjective.*

Corollary 5.6. *Basic selfinjective algebras are Frobenius algebras.*

There are examples of finite-dimensional selfinjective algebras which are not Frobenius algebras.

For more details on Frobenius algebras we recommend [SY11, Section IV].

5.1.4. Weakly symmetric algebras.

A finite-dimensional algebra A is **weakly symmetric** if for each simple A -module S , the projective cover $P(S)$ of S is isomorphic to the injective hull $I(S)$ of S .

Weakly symmetric algebras are selfinjective. The converse is in general wrong.

5.1.5. Symmetric algebras.

A finite-dimensional K -algebra A is a **symmetric algebra** if there exists a non-degenerate symmetric K -bilinear form

$$(-, ?): A \times A \rightarrow K$$

such that $(ab, c) = (a, bc)$ for all $a, b, c \in A$.

Symmetric algebras are weakly symmetric. The converse is in general wrong.

Theorem 5.7 (Brauer, Nesbitt, Nakayama (1937-1941)). *For a finite-dimensional K -algebra the following are equivalent:*

- (i) A is symmetric.
- (ii) There exists an isomorphism

$${}_A A_A \rightarrow {}_A D(A_A)_A$$

of A - A -bimodules.

Here are some classes of symmetric algebras:

- group algebras KG for G a finite group;
- blocks of group algebras KG for G a finite group;
- trivial extension algebras $T(A)$ for A a finite-dimensional algebra.

Symmetric algebras are weakly symmetric.

Example: Let $q \in K^*$, and let $A_q = KQ/I_q$ where Q is the quiver

$$a \begin{array}{c} \curvearrowright \\ \curvearrowleft \end{array} 1 \begin{array}{c} \curvearrowright \\ \curvearrowleft \end{array} b$$

and I_q is generated by $\{a^2, b^2, ab - qba\}$. Then A_q is weakly symmetric for all q , and A_q is symmetric if and only if $q = 1$.

For more details on symmetric algebras we recommend [SY11, Section IV].

LITERATURE – SELF-INJECTIVE ALGEBRAS

[SY11] A. Skowroński, K. Yamagata, *Frobenius algebras. I. Basic representation theory*. EMS Textbooks in Mathematics. European Mathematical Society (EMS), Zrich, 2011. xii+650 pp.

Back to Overview §5 Selfinjective.

5.2. Trivial extension and repetitive algebras. Let A be a finite-dimensional K -algebra. Recall that $D(A) := \text{Hom}_K(A, K)$ is an A - A -bimodule via

$$\begin{aligned} A \times D(A) &\rightarrow D(A) & D(A) \times A &\rightarrow D(A) \\ (a, f) &\mapsto [af: b \mapsto f(ba)] & (f, a) &\mapsto [fa: b \mapsto f(ab)]. \end{aligned}$$

5.2.1. *Trivial extension algebras.*

The **trivial extension algebra**

$$T(A) := A \ltimes D(A)$$

of A has $A \oplus D(A)$ as an underlying K -vector space, and its multiplication is defined by

$$(a, f) \cdot (b, g) := (ab, ag + fb)$$

for $a, b \in A$ and $f, g \in D(A)$.

Lemma 5.8. *Trivial extension algebras are symmetric.*

Proof. The map

$$\begin{aligned} (-, ?): T(A) \times T(A) &\rightarrow K \\ ((a, f), (b, g)) &\mapsto f(b) + g(a) \end{aligned}$$

is a non-degenerate symmetric K -bilinear form with $(xy, z) = (x, yz)$ for all $x, y, z \in T(A)$. In other words, $T(A)$ is symmetric. \square

The subspace $D(A)$ of $T(A)$ is a two-sided ideal of $T(A)$. This yields a K -algebra isomorphism $A \cong T(A)/D(A)$. Thus each finite-dimensional K -algebra is a factor algebra of a symmetric algebra.

Suppose that $A = KQ/I$ is a basic algebra such that I is generated by zero relations and commutativity relations. Then there is a combinatorial rule how to write $T(A)$ as a path algebra modulo an admissible ideal, see [FP02] and also [Sch99].

Using this, one can for example show the following:

Proposition 5.9. *The following are equivalent:*

- (i) A is a gentle algebra.
- (ii) $T(A)$ is a special biserial algebra.

The repetitive algebra \widehat{A} is infinite-dimensional provided $A \neq 0$. It has no identity element. But it has enough idempotents which serve as “local identities” and make it “locally finite-dimensional”.

Suppose that $A = KQ/I$ is a basic algebra such that I is generated by zero relations and commutativity relations. Then there is a combinatorial rule how to write \widehat{A} as a path algebra (of an infinite quiver) modulo an admissible ideal, see [Sch99].

Example: Let $A = KQ/I$ where Q is the quiver

$$a \circlearrowleft 1 \xleftarrow{b} 2 \circlearrowright c$$

and I is generated by $\{a^2, c^3, ab\}$. Then $\widehat{A} \cong K\widehat{Q}/\widehat{I}$ where \widehat{Q} is the quiver

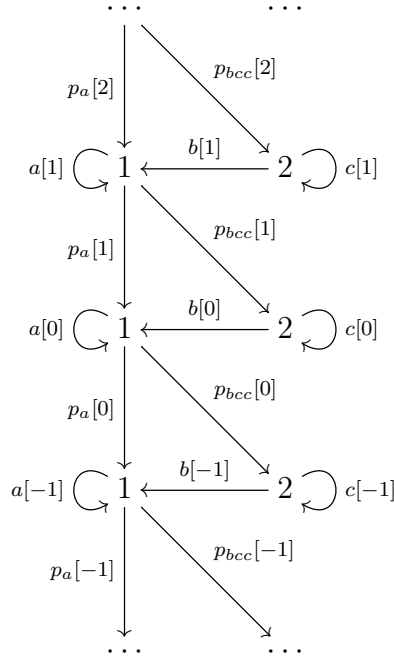

and \widehat{I} is generated by the relations

- $a[i]^2, c[i]^3, a[i]b[i]$,
- $p_a[i]a[i] - a[i-1]p_a[i]$,
- $p_{bcc}[i]b[i]c[i] - c[i-1]p_{bcc}[i]b[i]$,
- $p_a[i]a[i] - b[i-1]c[i-1]^2p_{bcc}[i]$,
- all paths which are not subpaths of $p_a[i]a[i]$, $a[i-1]p_a[i]$, $p_{bcc}[i]b[i]c[i]^2$, $c[i-1]p_{bcc}[i]b[i]c[i]$, $c[i-1]^2p_{bcc}[i]b[i]$ or $b[i-1]c[i-1]^2p_{bcc}[i]$

where i runs through \mathbb{Z} .

Proposition 5.10 ([H88]). *The following hold:*

- (i) \widehat{A} is selfinjective.
- (ii) The indecomposable projective-injective \widehat{A} -modules are finite-dimensional.
- (iii) The stable category $\underline{\text{mod}}(\widehat{A})$ is a triangulated category.

Happel [H88, Section II.4] constructed a functor

$$F: D^b(\text{mod}(A)) \rightarrow \underline{\text{mod}}(\widehat{A})$$

of triangulated categories.

We also refer to [BM06] for a detailed explanation of the construction of F .

Theorem 5.11 (Happel [H88, Section II.4]). *The Happel functor F is full and faithful. It is an equivalence if and only if $\text{gl. dim}(A) < \infty$.*

The categories $\text{mod}(\widehat{A})$ and $\text{mod}^{\mathbb{Z}}(T(A))$ are equivalent, see [H88, Section II.2.4].

LITERATURE – TRIVIAL EXTENSION AND REPETITIVE ALGEBRAS

- [BM06] M. Barot, O. Mendoza, *An explicit construction for the Happel functor*, Colloq. Math. 104 (2006), no. 1, 141–149.
- [C09] X.-W. Chen, *Graded self-injective algebras “are” trivial extensions*. J. Algebra 322 (2009), no. 7, 2601–2606.
- [FP02] E. Fernández, M. Platzeck, *Presentations of trivial extensions of finite dimensional algebras and a theorem of Sheila Brenner*. J. Algebra 249 (2002), no. 2, 326–344.
- [FP06] E. Fernández, M. Platzeck, *Isomorphic trivial extensions of finite dimensional algebras*. J. Pure Appl. Algebra 204 (2006), no. 1, 9–20.
- [H87] D. Happel, *On the derived category of a finite-dimensional algebra*. Comment. Math. Helv. 62 (1987), no. 3, 339–389.
- [H88] D. Happel, *Triangulated categories in the representation theory of finite-dimensional algebras*, London Mathematical Society Lecture Note Series, 119. Cambridge University Press, Cambridge, 1988. x+208pp.
- [MY20] H. Minamoto, K. Yamaura, *Homological dimension formulas for trivial extension algebras*. J. Pure Appl. Algebra 224 (2020), no. 8, 106344, 30 pp.
- [MY21] H. Minamoto, K. Yamaura, *The Happel functor and homologically well-graded Iwanaga-Gorenstein algebras*. J. Algebra 565 (2021), 441–488.
- [Sch99] J. Schröer, *On the quiver with relations of a repetitive algebra*, Arch. Math. (Basel) 72 (1999), no. 6, 426–432.
- [S15] S. Schroll, *Trivial extensions of gentle algebras and Brauer graph algebras*. J. Algebra 444 (2015), 183–200.

Back to Overview §5 Selfinjective.

5.3. Group algebras.

Let G be a group, and let KG be a K -vector space with a basis $\{b_g \mid g \in G\}$ indexed by the elements in G . Define

$$b_g b_h := b_{gh}.$$

Extending this linearly turns the vector space KG into a K -algebra. One calls KG the **group algebra** of G over K .

Clearly, KG is finite-dimensional if and only if G is a finite group.

A **representation** of G over K is a group homomorphism

$$\rho: G \rightarrow \mathrm{GL}(V)$$

where V is a K -vector space.

In the obvious way one can define homomorphisms of representations.

The category of representations of G over K is isomorphic to the category $\mathrm{Mod}(KG)$.

The representation theory of KG depends very much on the field K . In particular, the characteristic $\mathrm{char}(K)$ plays an important role.

Theorem 5.12 (Maschke). *Let G be a finite group, and let K be a field such that $\mathrm{char}(K)$ does not divide $|G|$. Then KG is semisimple.*

Even for semisimple group algebras there are many intriguing problems and conjectures. For example, one can try to construct the simple representations, determine their characters and describe tensor products of simples, etc. This would rather run under the label *Representation theory of finite groups* and not under *Representation theory of finite-dimensional algebras*. Of course one should not think of a rigid border between these research areas.

Let G be a finite group. Suppose that $\mathrm{char}(K)$ divides $|G|$. Then KG is not semisimple. The representation theory of KG runs then under the label *modular representation theory of finite groups*.

There are many beautiful long standing conjectures on the (modular and non-modular) representation theory of finite groups.

Proposition 5.13. *Group algebras are symmetric.*

Proof. The map

$$\begin{aligned} (-, ?): KG \times KG &\rightarrow K \\ \left(\sum_{g \in G} \lambda_g e_g, \sum_{g \in G} \mu_g e_g \right) &\mapsto \sum_{g \in G} \lambda_g \mu_{g^{-1}} \end{aligned}$$

is a non-degenerate symmetric K -bilinear form with $(xy, z) = (x, yz)$ for all $x, y, z \in KG$. In other words, KG is symmetric. \square

One can also show that blocks of group algebras are always symmetric. (For the definition of a *block* we refer to Section 11.7.) Note however that blocks of group algebras are in general not isomorphic to group algebras.

There is a rather well developed representation theory of finite-dimensional symmetric K -algebras.

Assume from now on that K is algebraically closed with $p = \text{char}(K) > 0$.

Theorem 5.14 (Higman [H54]). *Let G be a finite group with $p \mid |G|$. Then the following are equivalent:*

- (i) KG is representation-finite.
- (ii) The p -Sylow subgroups of G are cyclic.

To determine the representation type of blocks of group algebras, we need the notion of a *defect group*.

Let H be a subgroup of a finite group G . We can see KH as a subalgebra of KG . For $U \in \text{mod}(KH)$ let

$$U^G := KG \otimes_{KH} U \in \text{mod}(KG)$$

be the *induced KG -module*. Then $M \in \text{mod}(KG)$ is **H -projective** if there exists some $U \in \text{mod}(KH)$ such that M is isomorphic to a direct summand of U^G .

Let B be a block of KG . A **defect group** of B is a minimal subgroup D of G such that all $M \in \text{mod}(B)$ are D -projective.

Note that there are several equivalent definitions of a defect group.

The defect groups of B form a G -conjugacy class of p -subgroups of G .

So one often speaks of *the* defect group of B .

The **principal block** of KG is the unique block B_0 which contains the trivial KG -module K . Its defect group is a p -Sylow subgroup of G .

Theorem 5.15 (Dade, Janusz, Kupisch (1966-1969)). *Let G be a finite group, and let B be a block of KG with defect group D . Then the following are equivalent:*

- (i) B is representation-finite.
- (ii) D is cyclic.
- (iii) B is Morita equivalent to a Brauer tree algebra.

For more details and also references for the next theorem we refer to [E90].

Theorem 5.16. *Let G be a finite group, and let B be a block of KG with defect group D . Then the following are equivalent:*

- (i) B is representation-infinite and tame.
- (ii) $\text{char}(K) = 2$ and D is dihedral, semidihedral or generalized quaternion.

If $\text{char}(K) = 2$ and D is dihedral, then B is Morita equivalent to a Brauer graph algebra.

Conjecture 5.17 (Donovan Conjecture). *Let D be a p -group. Then there are only finitely many Morita equivalence classes of blocks of group algebras with defect group D .*

Question 5.18. *Let B_1 and B_2 be blocks of some group algebras KG_1 and KG_2 , respectively. When are B_1 and B_2 derived equivalent?*

For blocks of symmetric groups, there is a spectacular answer to this question:

Theorem 5.19 (Chuang, Rouquier [CR08]). *Let G_1 and G_2 be symmetric groups, and let B_1 and B_2 be blocks of KG_1 and KG_2 , respectively. The following are equivalent:*

(i) *There is a triangle equivalence*

$$D^b(\text{mod}(B_1)) \rightarrow D^b(\text{mod}(B_2)).$$

(ii) *B_1 and B_2 have isomorphic defect groups.*

Apart from a few exceptions in case $p = 2$, (i) and (ii) are also equivalent to

(iii) *B_1 and B_2 have the same number of simple modules, up to isomorphism.*

LITERATURE – GROUP ALGEBRAS

- [CR08] J. Chuang, R. Rouquier, *Derived equivalences for symmetric groups and \mathfrak{sl}_2 -categorification*. Ann. of Math. (2) 167 (2008), no. 1, 245–298.
- [C19] D. Craven, *Representation theory of finite groups: a guidebook*. Universitext. Springer, Cham, 2019. viii+294 pp.
- [E90] K. Erdmann, *Blocks of tame representation type and related algebras*. Lecture Notes in Mathematics, 1428. Springer-Verlag, Berlin, 1990. xvi+312 pp.
- [H54] D Higman, *Indecomposable representations at characteristic p* . Duke Math. J. 21 (1954), 377–381.
- [S13] P. Schneider, *Modular representation theory of finite groups*. Springer, Dordrecht, 2013. viii+178 pp.
- [W16] P. Webb, *A course in finite group representation theory*. Cambridge Studies in Advanced Mathematics, 161. Cambridge University Press, Cambridge, 2016. xi+325 pp.

[Back to Overview §5 Selfinjective.](#)

5.4. Brauer tree and Brauer graph algebras. Brauer tree algebras were defined by Janusz [J69] and then generalized under the name Brauer graph algebras by Donovan and Freislich [DF78]. These algebras appear in the representation theory of blocks of group algebras KG of certain finite groups G .

A **Brauer graph** is a tuple $G = (G_0, Q_1, m, o)$ where

- (G_0, G_1) is a finite unoriented connected graph (loops and multiple edges are allowed) with vertex set G_0 and edge set G_1 with $G_1 \neq \emptyset$,
- $m: G_0 \rightarrow \mathbb{N}_1$ is a map which assigns a *multiplicity* to each vertex,
- o gives for each vertex $v \in G_0$ a circular order $i_1 < i_2 < \dots < i_t < i_1$ of the (half-)edges incident to v . A loop contributes two (half-)edges.

For a vertex $v \in G_0$ let $\text{val}(v)$ be its *valency*, i.e. the number of edges incident to v where loops are counted twice.

Let $v \in G_0$ with $\text{val}(v) = 1$, and let $i \in G_1$ be incident to v . If $m(v) \geq 2$, then the circular order associated with v is by convention $i < i$. (For $\text{val}(v)m(v) = 1$, we do not need any circular order.)

Given a Bauer graph G , one defines a quiver Q_G as follows: The vertices of Q_G are the edges of G . For each vertex $v \in G_0$ with $\text{val}(v)m(v) \geq 2$ let $i_1 < i_2 < \dots < i_t < i_1$ be the circular order associated with v . Then we have arrows $a_k: i_k \rightarrow i_{k+1}$ for $1 \leq k \leq t-1$ and $a_t: i_t \rightarrow i_1$ in Q_G .

By definition, for each $v \in G_0$ with $\text{val}(v)m(v) \geq 2$ there is an oriented cycle $a_t \cdots a_1$ in Q_G associated with v . (In this case, $a_i \cdots a_1 a_t \cdots a_{i+1}$ is of course also an oriented cycle for each $1 \leq i \leq t-1$.) Each of these cycles is called a v -cycle.

There are three types of relations defining an admissible ideal I_G in KQ_G :

- (1) Let i be an edge in G connecting vertices v_1 and v_2 such that $\text{val}(v_k)m(v_k) \geq 2$ for $k = 1, 2$. Let C_{v_1} be a v_1 -cycle, and let C_{v_2} be a v_2 -cycle such that $s(C_{v_1}) = s(C_{v_2})$. Then let

$$C_{v_1}^{m(v_1)} - C_{v_2}^{m(v_2)} \in I_G.$$

- (2) Let $v \in G_0$ with $m(v)\text{val}(v) \geq 2$. For each v -cycle $C_v = a_t \cdots a_1$ let

$$a_1 C_v^{m(v)} \in I_G.$$

- (3) Let a and b be arrows in Q_G with $s(a) = t(b)$. If ab is not a subpath of any v -cycle $C_v = a_t \cdots a_1$, then

$$ab \in I_G.$$

There is one exception to this rule: If $a = b$ and $C_v = a$ is a v -cycle, then $ab \notin I_G$.

Note that the relations of type (2) are often redundant.

The algebra

$$A_G := KQ_G/I_G$$

is called a **Brauer graph algebra**.

Let $G = (G_0, G_1, m, o)$ be

$$v_1 \xrightarrow{1} v_2$$

with $m(v_1) = m(v_2) = 1$. Then Q_G has one vertex 1 and no arrows. So by the definition above, we have $A_G = K$. However, there is a convention which makes an exception here and defines $A_G := K[T]/(T^2)$. Furthermore, $A = K$ is also considered a Brauer graph algebra (with no Brauer graph associated with it).

Examples:

(i) Let G be

$$1 \circlearrowleft v_1$$

with $m(v_1) = m \geq 1$. The circular order for v_1 is $1 < 1 < 1$. Then Q_G is

$$a_1 \circlearrowleft 1 \circlearrowright a_2$$

and the generators of I_G are

- (1) $(a_2 a_1)^m - (a_1 a_2)^m$
- (2) $a_1 (a_2 a_1)^m, a_2 (a_1 a_2)^m$
- (3) a_1^2, a_2^2

(ii) Let G be

$$1 \circlearrowleft v_1 \circlearrowright 2$$

with $m(v_1) = 2$. Let $1 < 1 < 2 < 2 < 1$ be the circular order for v_1 . Then Q_G is

$$a_1 \circlearrowleft 1 \begin{array}{c} \xrightarrow{a_2} \\ \xleftarrow{a_4} \end{array} 2 \circlearrowright a_3$$

and the generators of I_G are

- (1) $(a_4 a_3 a_2 a_1)^2 - (a_1 a_4 a_3 a_2)^2, (a_2 a_1 a_4 a_3)^2 - (a_3 a_2 a_1 a_4)^2$
- (2) $a_1 (a_4 a_3 a_2 a_1)^2, a_2 (a_1 a_4 a_3 a_2)^2, a_3 (a_2 a_1 a_4 a_3)^2, a_4 (a_3 a_2 a_1 a_4)^2$
- (3) $a_1^2, a_3^2, a_2 a_4, a_4 a_2$

If we choose the circular order $1 < 2 < 1 < 2 < 1$ for v_1 , the quiver Q_G is

$$\begin{array}{ccc} & a_3 & \\ & \curvearrowright & \\ 1 & \xrightarrow{a_1} & 2 \\ & \curvearrowleft & \\ & a_4 & \end{array}$$

We omit to display the relations for this case.

(iii) Let G be

$$v_1 \xrightarrow{1} v_2$$

with $m(v_1) = 1$ and $m(v_2) \geq 2$. Then Q_G is

$$1 \circlearrowright a_1$$

and the generators of I_G are

- (1) –
- (2) $a_1^{m(v_2)+1}$
- (3) –

(iv) This example is taken from [Sch18]. Let G be

$$1 \circlearrowleft v_1 \begin{array}{c} \xrightarrow{2} \\ \xrightarrow{3} \end{array} v_2 \xrightarrow{4} v_3$$

with $m(v_1) = m(v_2) = m(v_3) = 1$. The circular order for v_1 is $1 < 1 < 2 < 3 < 1$, and the order for v_2 is $2 < 4 < 3 < 2$. Then Q_G is

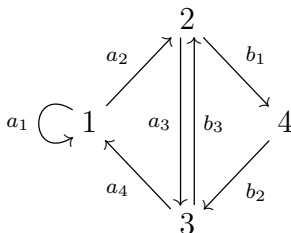

and the generators of I_G are

- (1) $a_4 a_3 a_2 a_1 - a_1 a_4 a_3 a_2$, $a_2 a_1 a_4 a_3 - b_3 b_2 b_1$, $a_3 a_2 a_1 a_4 - b_2 b_1 b_3$
- (2) $a_1(a_4 a_3 a_2 a_1)$, $a_2(a_1 a_4 a_3 a_2)$, $a_3(a_2 a_1 a_4 a_3)$, $a_4(a_3 a_2 a_1 a_4)$,
 $b_1(b_3 b_2 b_1)$, $b_2(b_1 b_3 b_2)$, $b_3(b_2 b_1 b_3)$
- (3) a_1^2 , $a_2 a_4$, $b_1 a_2$, $a_4 b_2$, $b_3 a_3$, $a_3 b_3$

The next theorem is essentially due to Roggenkamp [Ro98], see also [Sch15].

Theorem 5.20. *For a finite-dimensional connected basic K -algebra $A = KQ/I$ the following are equivalent:*

- (i) *A is a symmetric special biserial algebra.*
- (ii) *A is a Brauer graph algebra.*

A Brauer graph $G = (G_0, G_1, m, o)$ is a **Brauer tree** if (G_0, G_1) is a tree (no loops, no multiple edges) and $m(v) = 1$ for all but at most one $v \in G_0$. In this case, A_G is a **Brauer tree algebra**.

Proposition 5.21. *For a Brauer graph algebra A the following are equivalent:*

- (i) *A is representation-finite.*
- (ii) *A is a Brauer tree algebra.*

Theorem 5.22 (Gabriel, Riedtmann [GR79], Rickard [R89]). *For a finite-dimensional connected selfinjective K -algebra A , the following equivalent:*

- (i) *A is Morita equivalent to a Brauer tree algebra.*
- (ii) *A is stably equivalent to a symmetric Nakayama algebra.*
- (iii) *A is derived equivalent to a symmetric Nakayama algebra.*

LITERATURE – BRAUER TREE AND BRAUER GRAPH ALGEBRAS

- [DF78] P. Donovan, M.-R. Freislich, *The indecomposable modular representations of certain groups with dihedral Sylow subgroup*. Math. Ann. 238 (1978), no. 3, 207–216.

- [GR79] P. Gabriel, C. Riedtmann, *Group representations without groups*. Comment. Math. Helv. 54 (1979), no. 2, 240–287.
- [J69] G. Janusz, *Indecomposable modules for finite groups*. Ann. of Math. (2) 89 (1969), 209–241.
- [R89] J. Rickard, *Derived categories and stable equivalence*. J. Pure Appl. Algebra 61 (1989), no. 3, 303–317.
- [Ro98] K. Roggenkamp, *Biserial algebras and graphs*. Algebras and modules, II (Geiranger, 1996), 481–496, CMS Conf. Proc., 24, Amer. Math. Soc., Providence, RI, 1998.
- [Sch15] S. Schroll, *Trivial extensions of gentle algebras and Brauer graph algebras*. J. Algebra 444 (2015), 183–200.
- [Sch18] S. Schroll, *Brauer graph algebras: a survey on Brauer graph algebras, associated gentle algebras and their connections to cluster theory*. Homological methods, representation theory, and cluster algebras, 177–223, CRM Short Courses, Springer, Cham, 2018.

Back to Overview §5 Selfinjective.

5.5. Periodic algebras. Let A be a finite-dimensional K -algebra.

$M \in \text{mod}(A)$ is **Ω -periodic** if

$$\Omega_A^m(M) \cong M$$

for some $m \geq 1$. (Here $\Omega_A(M)$ is by definition the kernel of the projective cover $P \rightarrow M$.)

$M \in \text{mod}(A)$ is **τ -periodic** if

$$\tau_A^m(M) \cong M$$

for some $m \geq 1$. (Here τ_A is the Auslander-Reiten translation.)

Proposition 5.23. *If all non-projective $M \in \text{ind}(A)$ are Ω -periodic (resp. τ -periodic), then A is selfinjective.*

Proposition 5.24 ([SY11, Section 10]). *Let A be selfinjective and representation-finite. Then all non-projective $M \in \text{ind}(A)$ are Ω -periodic and τ -periodic.*

Let $A^e := A \otimes_K A^{\text{op}}$ denote the **enveloping algebra** of A . Recall that A^e acts on A by

$$(x \otimes y)a := xay.$$

A is a **periodic algebra** if A is Ω -periodic as an A^e -module.

Proposition 5.25 ([SY11, Theorem 11.19(i)]). *If A is periodic, then all non-projective $M \in \text{ind}(A)$ are Ω -periodic.*

Examples:

- (i) Let K be algebraically closed, and let A be connected, not semisimple, selfinjective and representation-finite. Then A is periodic, see [D10] and references therein.
- (ii) Brauer tree algebras which are not semisimple are periodic. This is a special case of (i).
- (iii) Let Q be an acyclic quiver, and let $A = T(KQ)$ be the trivial extension algebra of the path algebra KQ . Then A is periodic if and only if Q is a Dynkin quiver, see [BBK02, Theorems 2.1 and 2.2].
- (iv) Let Q be a Dynkin quiver, and let $A = \Pi(Q)$ be the associated preprojective algebra. If Q is not of type A_1 , then A is periodic, see [ES98, Theorem 7.3] and references therein.

Algebras A such that the trivial extension algebra $T(A)$ is periodic are studied in [CDIM20].

Theorem 5.26 ([ES08, Theorem 2.9]). *Let A and B be connected finite-dimensional K -algebras. If there is a triangle equivalence*

$$D^b(\text{mod}(A)) \simeq D^b(\text{mod}(B)),$$

then A is periodic if and only if B is periodic.

For a K -algebra automorphism $\sigma: A \rightarrow A$ let ${}_{\sigma}A_1$ be the A^e -module defined by

$$(x \otimes y)a := \sigma(x)ay.$$

A is a **twisted periodic algebra** if there exists some $n \geq 1$ and a K -algebra automorphism $\sigma: A \rightarrow A$ such that

$$\Omega_{A^e}^n(A) \cong {}_{\sigma}A_1$$

in $\text{mod}(A^e)$.

Obviously, each periodic algebra is twisted periodic.

Proposition 5.27 (Green, Snashall, Solberg [GSS03, Lemma 1.5], [SY11, Proposition 11.18]). *Twisted periodic algebras are selfinjective.*

Recall that A is **separable** if A is projective as an A^e -module.

Theorem 5.28 (Green, Snashall, Solberg [GSS03, Theorem 1.4]). *Assume that A is connected and not semisimple, and that $A/J(A)$ is a separable K -algebra. For $n \geq 1$ the following are equivalent:*

(i) $\Omega^n(A/J(A)) \cong A/J(A)$.

(ii) *There exists a K -algebra automorphism $\sigma: A \rightarrow A$ such that*

$$\Omega_{A^e}^n(A) \cong {}_{\sigma}A_1$$

in $\text{mod}(A^e)$.

(iii) *There exists a natural isomorphism*

$$\sigma^* \cong \Omega^n$$

of endofunctors $\underline{\text{mod}}(A) \rightarrow \underline{\text{mod}}(A)$ for some K -algebra automorphism $\sigma: A \rightarrow A$.

Note that (i) is equivalent to the condition that all simple A -modules are Ω -periodic, and (ii) says that A is twisted periodic. In (iii), σ^* denotes the obvious endofunctor induced by σ .

For more details on the previous theorem we also refer to [SY11, Theorem 12.2], [CDIM20, Proposition 3.3] and [H20, Corollary 2.2].

Conjecture 5.29 (Periodicity Conjecture [ES08]). *Every twisted periodic algebra is periodic.*

LITERATURE – PERIODIC ALGEBRAS

- [BBK02] S. Brenner, M. Butler, A. King, *Periodic algebras which are almost Koszul*. *Algebr. Represent. Theory* 5 (2002), no. 4, 331–367.
- [CDIM20] A. Chan, E. Darpö, O. Iyama, R. Marczinzik, *Periodic trivial extension algebras and fractionally Calabi-Yau algebras*. Preprint (2020), 33pp., arXiv:2012.11927
- [D10] A. Dugas, *Periodic resolutions and self-injective algebras of finite type*. *J. Pure Appl. Algebra* 214 (2010), no. 6, 990–1000.
- [ES08] K. Erdmann, A. Skowroński, *Periodic algebras*. Trends in representation theory of algebras and related topics, 201–251, EMS Ser. Congr. Rep., Eur. Math. Soc., Zürich, 2008.
blue (A well written survey article on selfinjective algebras in general and periodic algebras in particular.)
- [ES98] K. Erdmann, N. Snashall, *Preprojective algebras of Dynkin type, periodicity and the second Hochschild cohomology*. *Algebras and modules, II* (Geiranger, 1996), 183–193, CMS Conf. Proc., 24, Amer. Math. Soc., Providence, RI, 1998.
- [GSS03] E. Green, N. Snashall, O. Solberg, *The Hochschild cohomology ring of a selfinjective algebra of finite type*. *Proc. Amer. Math. Soc.* 131 (2003), 3387–3393.
- [H20] N. Hanihara, *Auslander correspondence for triangulated categories*. *Algebra Number Theory* 14 (2020), no. 8, 2037–2058.
- [SY11] A. Skowroński, K. Yamagata, *Frobenius algebras. I. Basic representation theory*. EMS Textbooks in Mathematics. European Mathematical Society (EMS), Zrich, 2011. xii+650 pp.

Back to Overview §5 Selfinjective.

5.6. **Hopf algebras.** In the following all tensor products are taken over K .

A K -**algebra** $A = (A, \mu, \eta)$ is a K -vector space A together with two K -linear maps

$$\mu: A \otimes A \rightarrow A \quad \text{and} \quad \eta: K \rightarrow A$$

such that the diagrams

$$\begin{array}{ccc} A \otimes A \otimes A & \xrightarrow{1 \otimes \mu} & A \otimes A \\ \mu \otimes 1 \downarrow & & \downarrow \mu \\ A \otimes A & \xrightarrow{\mu} & A \end{array} \quad \text{and} \quad \begin{array}{ccccc} K \otimes A & \xrightarrow{\eta \otimes 1} & A \otimes A & \xleftarrow{1 \otimes \eta} & A \otimes K \\ & \searrow \cong & \downarrow \mu & \swarrow \cong & \\ & & A & & \end{array}$$

commute. The map μ is the **multiplication** and η is the **unit** of A .

A K -**coalgebra** $C = (C, \Delta, \varepsilon)$ is a K -vector space C together with two K -linear maps

$$\Delta: C \rightarrow C \otimes C \quad \text{and} \quad \varepsilon: C \rightarrow K$$

such that the diagrams

$$\begin{array}{ccc} C & \xrightarrow{\Delta} & C \otimes C \\ \Delta \downarrow & & \downarrow 1 \otimes \Delta \\ C \otimes C & \xrightarrow{\Delta \otimes 1} & C \otimes C \otimes C \end{array} \quad \text{and} \quad \begin{array}{ccccc} K \otimes C & \xleftarrow{\varepsilon \otimes 1} & C \otimes C & \xrightarrow{1 \otimes \varepsilon} & C \otimes K \\ & \swarrow \cong & \uparrow \Delta & \searrow \cong & \\ & & C & & \end{array}$$

commute. The map Δ is the **comultiplication** and ε is the **counit** of C .

A K -**bialgebra** $H = (H, \mu, \eta, \Delta, \varepsilon)$ is given by a K -algebra (H, μ, η) and a K -coalgebra (H, Δ, ε) such that Δ and ε are K -algebra homomorphisms.

For such a K -bialgebra H and $X, Y \in \text{Mod}(H)$ the comultiplication $\Delta: H \rightarrow H \otimes H$ yields an H -module structure on $X \otimes Y$.

For a K -bialgebra $H = (H, \mu, \eta, \Delta, \varepsilon)$ the **convolution product** is defined as

$$\begin{aligned} *: \text{Hom}_K(H, H) \times \text{Hom}_K(H, H) &\rightarrow \text{Hom}_K(H, H) \\ (f, g) &\mapsto f * g \end{aligned}$$

where $f * g$ is the composition

$$H \xrightarrow{\Delta} H \otimes H \xrightarrow{f \otimes g} H \otimes H \xrightarrow{\mu} H.$$

A K -bialgebra $H = (H, \mu, \eta, \Delta, \varepsilon)$ is a **Hopf algebra** if there exists a K -linear map

$$s: H \rightarrow H$$

such that

$$s * 1_H = \eta\varepsilon = 1_H * s.$$

The map s is the **antipode** of H .

For such a Hopf algebra H and $X \in \text{Mod}(H)$ the antipode $s: H \rightarrow H$ yields an H -module structure on the K -dual $D(X)$.

Example: Let G be a finite group, and let $A = KG$ be its group algebra. Then A is a finite-dimensional Hopf algebra where

$$\begin{array}{lll} \Delta: A \rightarrow A \otimes A & \varepsilon: A \rightarrow K & s: A \rightarrow A \\ g \mapsto g \otimes g & g \mapsto 1 & g \mapsto g^{-1} \end{array}$$

are the comultiplication, counit and antipode, respectively.

The following result is a consequence of the Larson-Sweedler Theorem, see e.g. [SY11, Section VI.3].

Proposition 5.30. *Finite-dimensional Hopf algebras are Frobenius algebras.*

LITERATURE – HOPF ALGEBRAS

- [A80] E. Abe, *Hopf algebras*. Translated from the Japanese by Hisae Kinoshita and Hiroko Tanaka. Cambridge Tracts in Mathematics, 74. Cambridge University Press, Cambridge-New York, 1980. xii+284 pp.
- [SY11] A. Skowroński, K. Yamagata, *Frobenius algebras. I. Basic representation theory*. EMS Textbooks in Mathematics. European Mathematical Society (EMS), Zrich, 2011. xii+650 pp.

Back to Overview §5 Selfinjective.

6. Gorenstein algebras

§6 Gorenstein algebras:

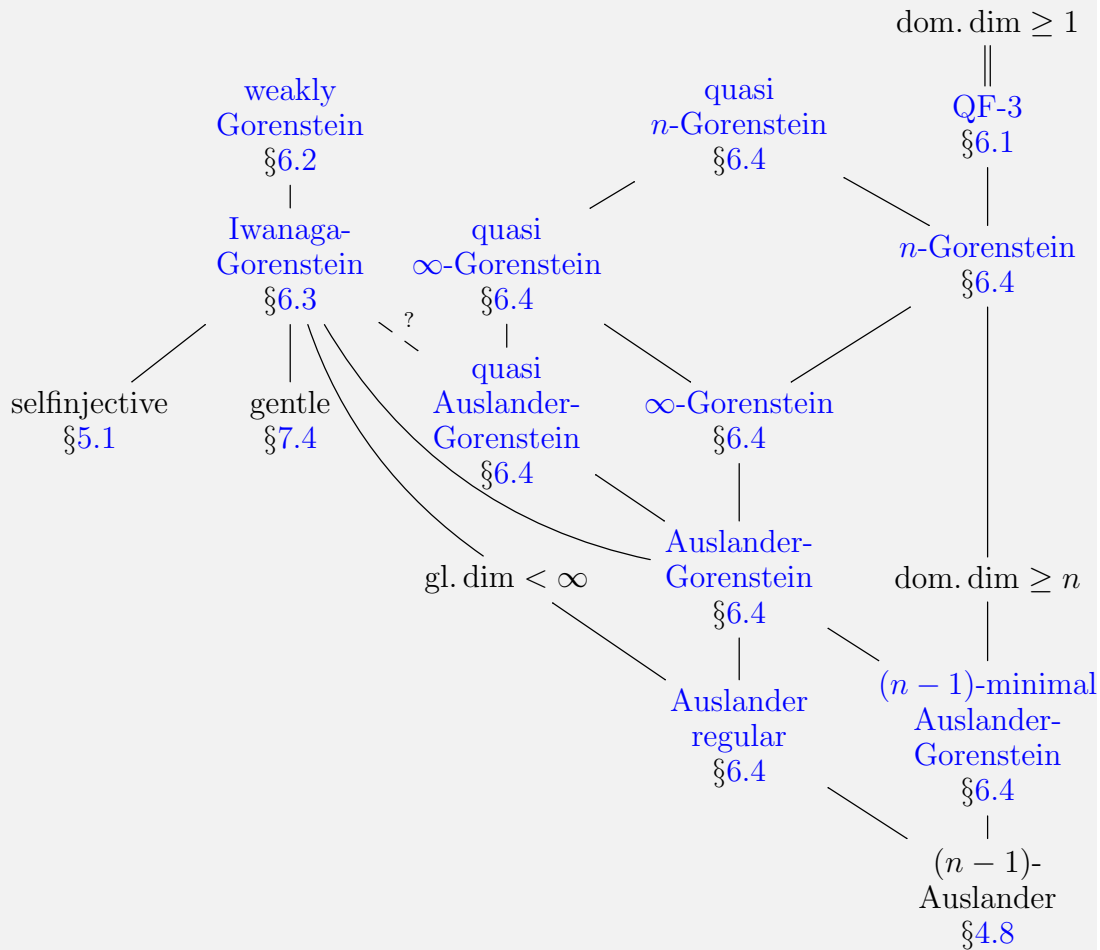

[Back to Overview Metaclasses 1.](#)

6.1. **QF-3 algebras.** Let A be a finite-dimensional K -algebra.

A is a **QF-3 algebra** if there exists a faithful projective-injective A -module.

Proposition 6.1. *The following are equivalent:*

- (i) A is a QF-3 algebra.
- (ii) $\text{dom. dim}(A) \geq 1$.
- (iii) *The injective envelope of ${}_A A$ is projective.*

QF-3 algebras play a crucial role in the Morita-Tachikawa correspondence, Auslander correspondence and Iyama's higher Auslander correspondence.

6.2. Weakly Gorenstein algebras. Let A be a finite-dimensional K -algebra.

6.2.1. Gorenstein projective modules. Let $M \in \text{mod}(A)$. The A^{op} -module $M^* := \text{Hom}_A(M, {}_A A)$ is the **A -dual** of M . Let

$$\phi_M: M \rightarrow M^{**}$$

be the A -module homomorphism defined by $\phi_M(m)(f) := f(m)$ for $m \in M$ and $f \in M^*$.

M is **torsionless** if M is isomorphic to a submodule of ${}_A A^m$ for some $m \geq 1$.

M is torsionless if and only if ϕ_M is a monomorphism.

M is **reflexive** if ϕ_M is an isomorphism.

A **complete projective resolution** is an exact sequence

$$P^\bullet: \dots \rightarrow P^{-1} \rightarrow P^0 \rightarrow P^1 \rightarrow \dots$$

with $P^i \in \text{proj}(A)$ for all $i \in \mathbb{Z}$ such that $\text{Hom}_A(P^\bullet, {}_A A)$ is also exact.

The module M is **Gorenstein projective** if there exists such a complete projective resolution

$$\dots \rightarrow P^{-1} \rightarrow P^0 \xrightarrow{d^0} P^1 \rightarrow \dots$$

with $\text{Im}(d^0) \cong M$. The subcategory of Gorenstein projective A -modules is denoted by $\text{gp}(A)$.

All modules in $\text{gp}(A)$ are torsionless.

Let

$${}^\perp A := \{M \in \text{mod}(A) \mid \text{Ext}_A^i(M, {}_A A) = 0 \text{ for all } i \geq 1\}.$$

The modules in ${}^\perp A$ are called **semi Gorenstein projective**.

Let \mathcal{C} be an **exact subcategory** of $\text{mod}(A)$, i.e. \mathcal{C} is a full subcategory, $0 \in \mathcal{C}$ and if

$$0 \rightarrow X \rightarrow Y \rightarrow Z \rightarrow 0$$

is a short exact sequence with $X, Z \in \mathcal{C}$, then $Y \in \mathcal{C}$. Then \mathcal{C} is an exact category where the exact structure for \mathcal{C} is induced by the exact structure for $\text{mod}(A)$.

The subcategories $\text{gp}(A)$ and ${}^\perp A$ are exact subcategories of $\text{mod}(A)$, and we have

$$\text{gp}(A) \subseteq {}^\perp A.$$

Examples of semi Gorenstein projective modules which are not Gorenstein projective can be found in [JS06] and [M17].

An exact category \mathcal{F} is a **Frobenius category** if \mathcal{F} has enough projective and enough injective objects, and if the class $\mathcal{P}(\mathcal{F})$ of projective objects in \mathcal{F} coincide with the class $\mathcal{I}(\mathcal{F})$ of injective objects in \mathcal{F} .

Proposition 6.2. $\text{gp}(A)$ is a Frobenius category with $\mathcal{P}(\text{gp}(A)) = \text{proj}(A)$.

Happel proved that the stable category $\underline{\mathcal{F}}$ of a Frobenius category \mathcal{F} is triangulated. Thus we get the following:

Corollary 6.3. *The stable category $\underline{\text{gp}(A)}$ is a triangulated category.*

As a good survey on Gorenstein homological algebra we recommend [C10].

6.2.2. *Weakly Gorenstein algebras.* The following definition is due to Ringel and Zhang [RZ20a].

A is a **weakly Gorenstein algebra** if

$$\text{gp}(A) = {}^\perp A.$$

Theorem 6.4 (Ringel, Zhang [RZ20a]). *The following are equivalent:*

- (i) A is weakly Gorenstein.
- (ii) ϕ_M is a monomorphism (i.e. M is torsionless) for all $M \in {}^\perp A$.
- (iii) ϕ_M is an epimorphism for all $M \in {}^\perp A$.
- (iv) ϕ_M is an isomorphism (i.e. M is reflexive) for all $M \in {}^\perp A$.

6.3. **Iwanaga-Gorenstein algebras.** Let A be a finite-dimensional K -algebra.

Conjecture 6.5 (Gorenstein Symmetry Conjecture [ARS97]). *The following are equivalent:*

- (i) $\text{proj. dim}(D(A_A)) < \infty$.
- (ii) $\text{inj. dim}({}_A A) < \infty$.

A is an **Iwanaga-Gorenstein algebra** if

$$\text{proj. dim}(D(A_A)) < \infty \quad \text{and} \quad \text{inj. dim}({}_A A) < \infty.$$

In this case, we have $n := \text{proj. dim}(D(A_A)) = \text{inj. dim}({}_A A)$, and we say that A is an **n -Iwanaga-Gorenstein algebra**.

Example: For $n \geq 2$ let $A = KQ/I$ where Q is the quiver

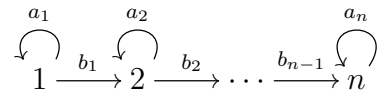

and I is generated by

$$\{a_i^2 \mid 1 \leq i \leq n\} \cup \{b_i a_i - a_{i+1} b_i \mid 1 \leq i \leq n-1\} \cup \{b_{i+1} b_i \mid 1 \leq i \leq n-2\}.$$

We have

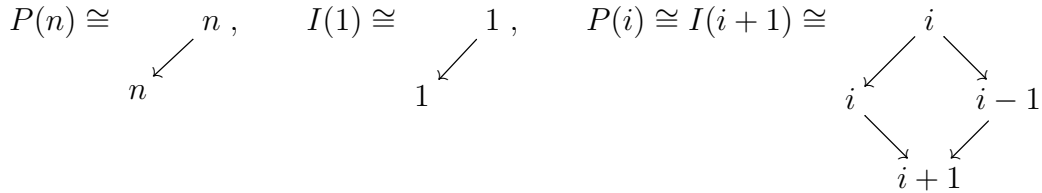

for $1 \leq i \leq n+1$. Now one checks easily that A is $(n-1)$ -Iwanaga-Gorenstein. Furthermore, we have $\text{dom. dim}(A) = n-1$ and $\text{gl. dim}(A) = \infty$.

Proposition 6.6. *The following hold:*

- (i) *If $\text{gl. dim}(A) = n < \infty$, then A is n -Iwanaga-Gorenstein.*
- (ii) *A is selfinjective if and only if A is 0-Iwanaga-Gorenstein.*

Proposition 6.7. *For an n -Iwanaga-Gorenstein algebra A , and $M \in \text{mod}(A)$ the following are equivalent:*

- (i) $\text{proj. dim}(M) \leq n$;
- (ii) $\text{proj. dim}(M) < \infty$;
- (iii) $\text{inj. dim}(M) \leq n$;
- (iv) $\text{inj. dim}(M) < \infty$.

Proposition 6.8. *For an Iwanaga-Gorenstein algebra A we have*

$$\mathrm{gp}(A) = {}^{\perp}A.$$

In other words, Iwanaga-Gorenstein algebras are weakly Gorenstein.

For an Iwanaga-Gorenstein algebra A the modules in $\mathrm{gp}(A)$ are often called **maximal Cohen-Macaulay modules**.

Let $d \geq 0$. Let $\Omega^d(\mathrm{mod}(A))$ be the subcategory of all $M \in \mathrm{mod}(A)$ such that M is isomorphic to a module of the form $P \oplus \Omega^d(N)$ for some $P \in \mathrm{proj}(A)$ and $N \in \mathrm{mod}(A)$. Dually, $\Omega^{-d}(\mathrm{mod}(A))$ is the subcategory of all $M \in \mathrm{mod}(A)$ such that M is isomorphic to a module of the form $I \oplus \Omega^{-d}(N)$ for some $I \in \mathrm{inj}(A)$ and $N \in \mathrm{mod}(A)$.

Proposition 6.9. *For all $n \geq 0$ we have*

$$\mathrm{gp}(A) \subseteq \Omega^n(\mathrm{mod}(A)).$$

Theorem 6.10. *For $n \geq 0$ the following are equivalent:*

- (i) A is n -Iwanaga-Gorenstein.
- (ii) $\mathrm{gp}(A) = \Omega^n(\mathrm{mod}(A))$.

Thus, for a 1-Iwanaga-Gorenstein algebra A we have

$$\mathrm{gp}(A) = \mathrm{cogen}({}_A A).$$

In other words, $M \in \mathrm{mod}(A)$ is Gorenstein projective if and only if M is isomorphic to a submodule of a finite-dimensional projective module.

Example: Let $A = KQ/I$ where Q is the quiver

$$1 \longrightarrow 2 \begin{array}{c} \curvearrowright \\ \curvearrowleft \end{array} a$$

and I is generated by a^2 . Then A is 1-Iwanaga-Gorenstein and

$$\mathrm{gp}(A) = \mathrm{add} \left(\begin{array}{c} 1 \\ 2 \oplus 2 \\ 2 \end{array} \oplus 2 \right).$$

Let $D^b(\mathrm{mod}(A))$ be the derived category of bounded complexes of finite-dimensional A -modules, and let $K^b(\mathrm{proj}(A))$ be the homotopy category of bounded complexes of finite-dimensional projective A -modules.

Considering $K^b(\text{proj}(A))$ and $K^b(\text{inj}(A))$ as subcategories of $D^b(\text{mod}(A))$, Happel [H91] showed that for A Iwanaga-Gorenstein, we have

$$K^b(\text{proj}(A)) = K^b(\text{inj}(A)).$$

The Verdier quotient

$$\text{Sing}(A) := D^b(\text{mod}(A))/K^b(\text{proj}(A))$$

is the **singularity category** of A .

If $\text{gl. dim}(A) < \infty$, then $K^b(\text{proj}(A))$ and $D^b(\text{mod}(A))$ are triangle equivalent and $\text{Sing}(A) = 0$. This is in line with the general philosophy that finite global dimension is associated with smooth (= non-singular) behaviour. Again philosophically speaking, the singularity category $\text{Sing}(A)$ measures how far away A (or $D^b(\text{mod}(A))$) is from being smooth.

Theorem 6.11 (Buchweitz [Bu]). *Let A be an Iwanaga-Gorenstein algebra. Then there is a triangle equivalence*

$$\underline{\text{gp}}(A) \simeq \text{Sing}(A).$$

There are numerous 1-Iwanaga-Gorenstein algebras appearing at the interface between representation theory of finite-dimensional algebras and the categorification of Fomin-Zelevinsky cluster algebras. We refer to [BIRS09, KR07, KR08] for more information. Other appearances of 1-Iwanaga-Gorenstein algebras can be found in [GLS17] and [RZ17].

6.4. n -Gorenstein algebras and Auslander-Gorenstein algebras. Let A be a finite-dimensional K -algebra, and let

$$0 \rightarrow {}_A A \rightarrow I_0 \rightarrow I_1 \rightarrow I_2 \rightarrow \cdots$$

be a minimal injective resolution of the regular representation ${}_A A$.

The **dominant dimension** of A is defined as

$$\text{dom. dim}(A) := \begin{cases} d & \text{if } I_i \in \text{proj}(A) \text{ for all } 0 \leq i \leq d-1 \text{ and } I_d \notin \text{proj}(A), \\ \infty & \text{if } I_i \in \text{proj}(A) \text{ for all } i \geq 0. \end{cases}$$

For $n \geq 1$, A is an **n -Gorenstein algebra** (resp. **quasi n -Gorenstein algebra**) if

$$\text{proj. dim}(I_i) \leq i \quad (\text{resp. } \text{proj. dim}(I_i) \leq i+1)$$

for all $0 \leq i \leq n-1$.

If $\text{dom. dim}(A) \geq n$, then A is n -Gorenstein. For $n = 1$, the converse is also true.

A is an ∞ -Gorenstein algebra (resp. quasi ∞ -Gorenstein algebra) if A is n -Gorenstein (resp. quasi n -Gorenstein) for all $n \geq 1$.

Proposition 6.12. *A is n -Gorenstein if and only if A^{op} is n -Gorenstein.*

The Nakayama Conjecture is a special case of the following conjecture.

Conjecture 6.13. *If A is an n -Gorenstein algebra for all $n \geq 1$, then A is an Iwanaga-Gorenstein algebra.*

Here is a more general conjecture:

Conjecture 6.14. *Suppose that*

$$\text{proj. dim}(I_i) < \infty$$

for all $i \geq 0$. Then A is an Iwanaga-Gorenstein algebra.

For $d \geq 0$, the subcategories $\Omega^d(\text{mod}(A))$ and $\Omega^{-d}(\text{mod}(A))$ are closed under finite direct sums, but in general they are not closed under direct summands.

Therefore, let $\mathcal{X}^d := \text{add}(\Omega^d(\text{mod}(A)))$ and $\mathcal{X}^{-d} := \text{add}(\Omega^{-d}(\text{mod}(A)))$.

Proposition 6.15 (Auslander, Reiten [AR94]). *Let A be an n -Gorenstein algebra. Then for $0 \leq d \leq n$ the following hold:*

- (i) \mathcal{X}^d is functorially finite.
- (ii) \mathcal{X}^d is closed under extensions.
- (iii) $\mathcal{X}^d = \Omega^d(\text{mod}(A))$.

Theorem 6.16 ([AR94]). *The following are equivalent:*

- (i) \mathcal{X}^d is closed under extensions for all $0 \leq d \leq n$.
- (ii) A is quasi n -Gorenstein.

In the situation of the theorem, \mathcal{X}^d has Auslander-Reiten sequences.

A is an **Auslander-Gorenstein algebra** (resp. **quasi Auslander-Gorenstein algebra**) if the following hold:

- (i) A is n -Gorenstein (resp. quasi n -Gorenstein) for all $n \geq 0$.
- (ii) $\text{inj. dim}({}_A A) < \infty$.

Example: Let $A = KQ/I$ where Q is the quiver

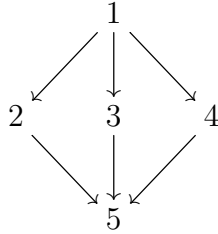

and I is generated by the set of all commutativity relations $p - q$ where p and q run through all paths of length 2 in Q . (Thus A is an incidence algebra.) We have $P(1) = I(5)$ and

$$\underline{\dim}(P(1)) = \begin{matrix} & 1 & \\ 1 & 1 & 1 \\ & 1 & \end{matrix}.$$

One easily checks that A is quasi Auslander-Gorenstein but not Auslander-Gorenstein.

Theorem 6.17 ([AR94, Corollary 5.5]). *Auslander-Gorenstein algebras are Iwanaga-Gorenstein.*

A is an **Auslander regular algebra** if the following hold:

- (i) A is n -Gorenstein for all $n \geq 0$.
- (ii) $\text{gl. dim}(A) < \infty$.

The following class of algebras is introduced and studied in [IS18].

For $n \geq 0$, A is **n -minimal Auslander-Gorenstein** if

$$\text{dom. dim}(A) \geq n + 1 \geq \text{inj. dim}({}_A A).$$

Each n -Auslander algebra is n -minimal Auslander-Gorenstein and also Auslander regular.

LITERATURE – GORENSTEIN ALGEBRAS

[ARS97] M. Auslander, I. Reiten, S. Smalø, *Representation theory of Artin algebras*, Corrected reprint of the 1995 original. Cambridge Studies in Advanced Mathematics, 36. Cambridge University Press, Cambridge, 1997. xiv+425 pp.

- [AR94] M. Auslander, I. Reiten, *k-Gorenstein algebras and syzygy modules*. J. Pure Appl. Algebra 92 (1994), no. 1, 1–27.
- [BIRS09] A. Buan, O. Iyama, I. Reiten, J. Scott, *Cluster structures for 2-Calabi-Yau categories and unipotent groups*, Compos. Math. 145 (2009), no. 4, 1035–1079.
- [Bu] R. Buchweitz, *Maximal Cohen-Macaulay modules and Tate cohomology over Gorenstein rings*, Preprint. Can be found in the www.
- [CIM19] A. Chan, O. Iyama, R. Marczinzik, *Auslander-Gorenstein algebras from Serre-formal algebras via replication*. Adv. Math. 345 (2019), 222–262.
- [C10] X. Chen, *Gorenstein Homological Algebra of Artin Algebras*, Postdoctoral Report, USTC, 2010. Can be found on Xiao-Wu Chen’s webpage.
- [GLS17] C. Geiß, B. Leclerc, J. Schröer, *Quivers with relations for symmetrizable Cartan matrices I: Foundations*. Invent. Math. 209 (2017), no. 1, 61–158.
- [H91] D. Happel, *On Gorenstein algebras*. Representation theory of finite groups and finite-dimensional algebras (Bielefeld, 1991), 389–404, Progr. Math., 95, Birkhäuser, Basel, 1991.
- [IS18] O. Iyama, Ø. Solberg, *Auslander-Gorenstein algebras and precluster tilting*. Adv. Math. 326 (2018), 200–240.
- [IZ19] O. Iyama, X. Zhang, *Tilting modules over Auslander-Gorenstein algebras*. Pacific J. Math. 298 (2019), no. 2, 399–416.
- [JS06] D. Jorgensen, L. Sega, *Independence of the total reflexivity conditions for modules*. Algebr. Represent. Theory 9 (2006), no. 2, 217–226.
- [KR07] B. Keller, I. Reiten, *Cluster-tilted algebras are Gorenstein and stably Calabi-Yau*, Adv. Math. 211 (2007), no. 1, 123–151.
- [KR08] B. Keller, I. Reiten, *Acyclic Calabi-Yau categories*. With an appendix by Michel Van den Bergh. Compos. Math. 144 (2008), no. 5, 1332–1348.
- [M17] R. Marczinzik, *On stable modules that are not Gorenstein projective*. arXiv:1709.01132v3
- [M18] R. Marczinzik, *On minimal Auslander-Gorenstein algebras and standardly stratified algebras*. J. Pure Appl. Algebra 222 (2018), no. 12, 4068–4081.
- [M19] R. Marczinzik, *On weakly Gorenstein algebras*. Preprint, arXiv:1908.04738
- [RZ17] C.M. Ringel, P. Zhang, *Representations of quivers over the algebra of dual numbers*. J. Algebra 475 (2017), 327–360.
- [RZ20a] C. Ringel, P. Zhang, *Gorenstein-projective and semi-Gorenstein-projective modules*. Algebra Number Theory 14 (2020), no. 1, 1–36.
- [RZ20b] C. Ringel, P. Zhang, *Gorenstein-projective and semi-Gorenstein-projective modules. II*. J. Pure Appl. Algebra 224 (2020), no. 6, 106248, 23 pp.

Back to Overview §6 Gorenstein.

7. Biserial algebras

§7 Biserial algebras:

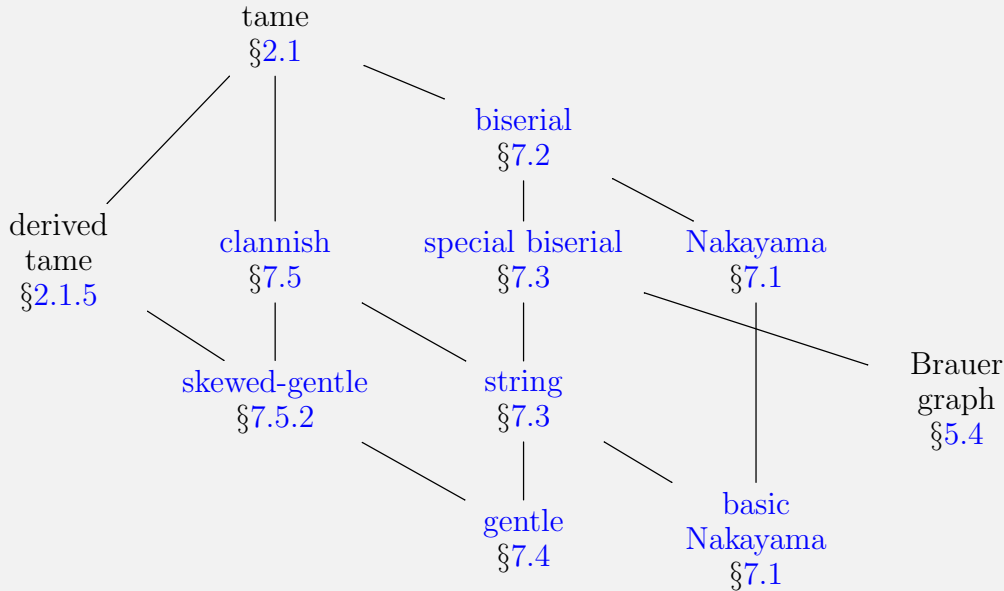

[Back to Overview Metaclasses 1.](#)

7.1. Nakayama algebras. Let A be a finite-dimensional K -algebra.

$M \in \text{mod}(A)$ is **uniserial** if it has a unique composition series.

In other word, there is a chain

$$0 = M_0 \subset M_1 \subset \cdots \subset M_t = M$$

of submodules of M such that M_i/M_{i-1} is simple for all $1 \leq i \leq t$ and M has exactly $t + 1$ submodules, namely M_0, \dots, M_t .

A finite-dimensional K -algebra A is a **Nakayama algebra** if each indecomposable projective left or right A -module is uniserial.

Thus A is a Nakayama algebra if and only if all indecomposable projective and all indecomposable injective (left) A -modules are uniserial.

Theorem 7.1 (Nakayama [N41]). *Let A be a Nakayama algebra. Then A is representation-finite, and each indecomposable A -module is uniserial. Up to isomorphism, the indecomposable A -modules are the non-zero factor modules of the indecomposable projective A -modules.*

Nakayama algebras were the first class of well studied representation-finite algebras. There is still some ongoing research on their homological behaviour.

Proposition 7.2. *Let $A = KQ/I$ be a basic algebra. Then A is a Nakayama algebra if and only if Q is of the form*

$$1 \longrightarrow 2 \longrightarrow \cdots \longrightarrow n \quad \text{or} \quad 1 \begin{array}{c} \longrightarrow 2 \longrightarrow \cdots \longrightarrow n \\ \longleftarrow \end{array}$$

for some $n \geq 1$.

Examples:

(i) Let $A = KQ/I$ where Q is the quiver

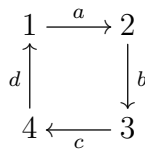

and I is generated by $\{dcba, adc\}$. We get

$$\begin{array}{cccc} P(1) = \begin{array}{c} 1 \\ 2 \\ 3 \\ 4 \end{array} & P(2) = I(1) = \begin{array}{c} 3 \\ 4 \\ 1 \end{array} & P(3) = \begin{array}{c} 3 \\ 4 \\ 1 \end{array} & P(4) = I(4) = \begin{array}{c} 4 \\ 1 \\ 3 \\ 4 \end{array} \\ I(2) = \begin{array}{c} 4 \\ 1 \\ 2 \end{array} & I(3) = \begin{array}{c} 4 \\ 1 \\ 2 \\ 3 \end{array} & & \end{array}$$

Clearly, A is a Nakayama algebra. We have $\text{dom. dim}(A) = 1$, $\text{fin. dim}(A) = 2$ and $\text{gl. dim}(A) = \infty$.

(ii) Let $A = KQ$ where Q is the quiver

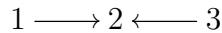

Then all indecomposable projective left A -modules are uniserial, but the indecomposable projective right A -module e_2A is not. Thus A is not a Nakayama algebra.

LITERATURE – NAKAYAMA ALGEBRAS

[ARS95] M. Auslander, I. Reiten, S. Smalø, *Representation theory of Artin algebras*, Corrected reprint of the 1995 original. Cambridge Studies in Advanced Mathematics, 36. Cambridge University Press, Cambridge, 1997. xiv+425 pp. [\(Contains a section on Nakayama algebras.\)](#)

[JK19] G. Jasso, J. Külshammer, *Higher Nakayama algebras I: Construction*. With an appendix by Külshammer and Chrysostomos Psaroudakis and an appendix by Sondre Kvamme. Adv. Math. 351 (2019), 1139–1200.

(In the spirit of higher Auslander-Reiten theory, the authors define and study the class of *higher Nakayama algebras*.)

- [M17] R. Marczinzik, *Dominant dimensions of algebras*. PhD thesis, Universität Stuttgart (2017).
(A detailed study of the homological behaviour of Nakayama algebras (e.g. their finitistic dimension and dominant dimension).)
- [N41] T. Nakayama, *On Frobeniusean algebras. II*. Ann. of Math. (2) 42 (1941), 1–21.

[Back to Overview Biserial 7.](#)

7.2. Biserial algebras.

A finite-dimensional K -algebra A is a **biserial algebra** if for each indecomposable projective left or right A -module P there exist uniserial submodules U_1 and U_2 of P such that

$$U_1 + U_2 = \text{rad}(P) \quad \text{and} \quad \text{length}(U_1 \cap U_2) \leq 1.$$

Biserial algebras were first studied by Fuller [F79].

Examples:

- (i) Nakayama algebras are biserial.
- (ii) Let $A = KQ/I$ where Q is the quiver

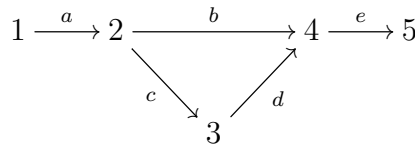

and I is generated by $\{eb, (b - dc)a\}$. Then A is basic biserial, but not special biserial. (The definition of special biserial algebras is further below.) The indecomposable projective A -modules are

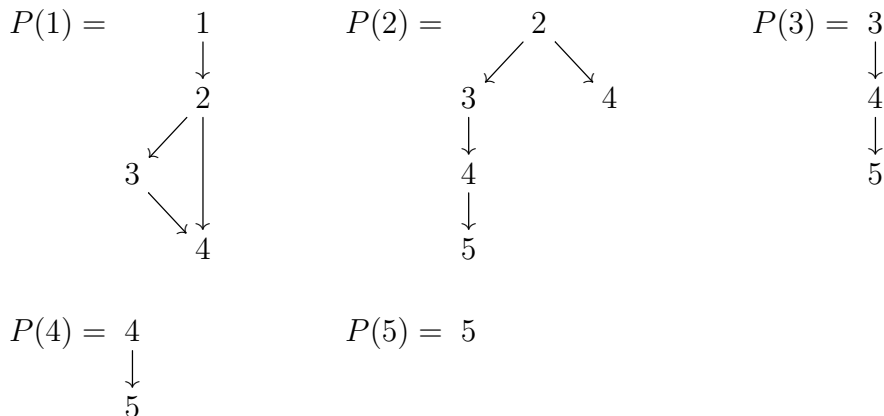

and the indecomposable injective A -modules (which are the duals of the indecomposable projective right A -modules) are

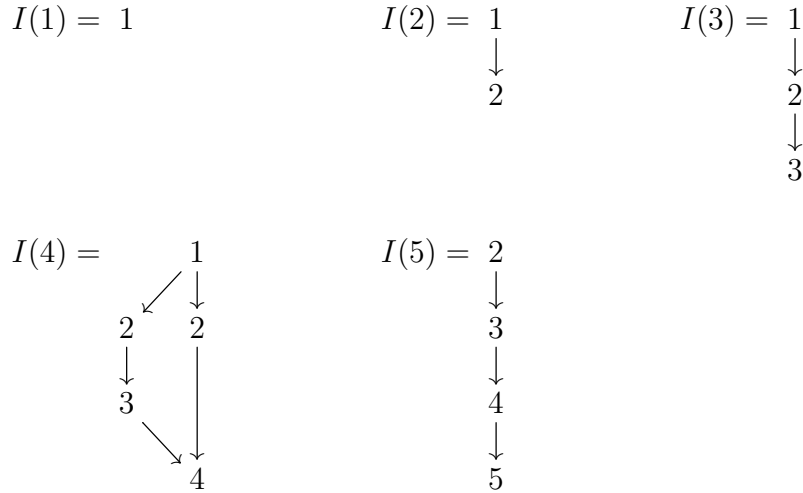

As usual, the numbers i in these drawings stand for basis vectors (each corresponding to a composition factor $S(i)$) and the arrows show how the arrows of the algebra act on these basis vectors. Note that for $I(4)$ we have $a_1 = 2 + 2$. So (against the intuition of the picture) we have $\text{top}(I(4)) \cong S(1) \oplus S(2)$. This example is taken from [SW83].

(iii) For $\lambda \in K$ let $A_\lambda = KQ/I_\lambda$ where Q is the quiver

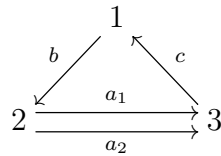

and I_λ is generated by $\{ca_1, (a_1 - \lambda a_2)b\}$ together with all paths of length 5. Then A_λ is basic biserial for all $\lambda \in K$. The choice of λ has a lot of influence on the representation theory of A_λ . Namely, A_λ is tame domestic if and only if $\lambda \neq 0$, whereas A_0 is tame of exponential growth. This example is taken from [K09].

We repeat now Vila-Freyer and Crawley-Boevey’s [VFCB98] characterization of biserial algebras in terms of quivers with relations.

A **bisection** of Q is a pair (σ, τ) of maps $Q_1 \rightarrow \{\pm 1\}$ such that the following hold:

- (i) For $a, b \in Q_1$ with $a \neq b$ and $s(a) = s(b)$ we have $\sigma(a) \neq \sigma(b)$.
- (ii) For $a, b \in Q_1$ with $a \neq b$ and $t(a) = t(b)$ we have $\tau(a) \neq \tau(b)$.

A quiver $Q = (Q_0, Q_1, s, t)$ is **biserial** if for each vertex $i \in Q_0$ we have

$$|\{a \in Q_1 \mid s(a) = i\}| \leq 2 \quad \text{and} \quad |\{a \in Q_1 \mid t(a) = i\}| \leq 2.$$

The quiver Q has a bisection if and only if Q is biserial.

Assume now that (σ, τ) is a bisection of Q .

A path $p = a_1 \cdots a_t$ of length $t \geq 2$ in Q is **(σ, τ) -good** if $\sigma(a_i) = \tau(a_{i+1})$ for $1 \leq i \leq t - 1$. Otherwise, p is **(σ, τ) -bad**.

For each (σ, τ) -bad path ax of length 2 (with $a, x \in Q_1$) we choose an element $d_{ax} \in KQ$ such that the following hold:

- (i) $d_{ax} = 0$ or $d_{ax} = \lambda_x b_1 \cdots b_t$ with $b_1 \cdots b_t$ a (σ, τ) -good path of length $t+1 \geq 2$ such that $t(b_1) = t(a)$, $b_1 \neq a$ and $\lambda_x \in K^*$.

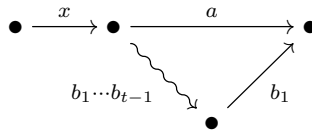

- (ii) If $d_{ax} = \lambda_x b$ and $d_{by} = \lambda_y a$ (with $a, x, b, y \in Q_1$) and $\lambda_x, \lambda_y \in K^*$, then $\lambda_x \lambda_y \neq 1$.

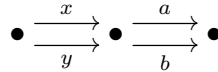

Then

$$\{ax - d_{ax}x \mid ax \text{ is a } (\sigma, \tau)\text{-bad path}\}$$

is a set of **(σ, τ) -relations**.

Theorem 7.3 (Vila-Freyer [VFCB98]). *Let K be algebraically closed. Each basic biserial K -algebra is isomorphic to KQ/I where Q is a biserial quiver and I is an admissible ideal containing a set of (σ, τ) -relations.*

Warning: The ideal generated by a set of (σ, τ) -relations might be non-admissible. Usually one needs to add further relations to ensure that it contains the ideal $KQ_{\geq m}$ for some $m \geq 2$. (Here $KQ_{\geq m}$ is the subspace of KQ which is spanned by all paths p in Q with $\text{length}(p) \geq m$.)

Külshammer [K11] gave a module theoretic characterization of biserial algebras.

The following result is proved via deformations of algebras. (Geiß [G95] proved that deformations of tame algebras are tame.)

Theorem 7.4 (Crawley-Boevey [CB95]). *Let K be algebraically closed. Biserial K -algebras are tame.*

Theorem 7.5 (Janusz [J69], Kupisch [K68]). *Let K be algebraically closed. Representation-finite group algebras KG are biserial, up to Morita equivalence.*

For most biserial algebras, the finite-dimensional indecomposable modules have been classified by Vila-Freyer in his PhD thesis [VF94]. Up to my knowledge, these results are not published elsewhere and the thesis is not easily accessible.

Most research on biserial algebras focusses on the subclasses of special biserial algebras, string algebras and gentle algebras.

LITERATURE – BISERIAL ALGEBRAS

- [CB95] W. Crawley-Boevey, *Tameness of biserial algebras*, Arch. Math. (Basel) 65 (1995), no. 5, 399–407.
- [VFCB98] R. Vila-Freyer, W. Crawley-Boevey, *The structure of biserial algebras*. J. London Math. Soc. (2) 57 (1998), no. 1, 41–54.
- [F79] K. Fuller, *Biserial rings*. Ring theory (Proc. Conf., Univ. Waterloo, Waterloo, 1978), pp. 64–90, Lecture Notes in Math., 734, Springer, Berlin, 1979.
- [G95] C. Geiß, *On degenerations of tame and wild algebras*. Arch. Math. (Basel) 64 (1995), no. 1, 11–16.
- [J69] G. Janusz, *Indecomposable modules for finite groups*. Ann. of Math. (2) 89 (1969), 209–241.
- [K09] J. Külshammer, *Biserielle Algebren*. Diplomarbeit, Universität Bonn (2009).
- [K11] J. Külshammer, *Biserial algebras via subalgebras and the path algebra of \mathbb{D}_4* . J. Algebra 331 (2011), 58–67.
- [K68] H. Kupisch, *Projektive Moduln endlicher Gruppen mit zyklischer p -Sylow-Gruppe*. (German) J. Algebra 10 (1968), 1–7.
- [SW83] S. Skowroński, J. Waschbüsch *Representation-finite biserial algebras*, J. Reine Angew. Math. 345 (1983), 172–181.
- [VF94] R. Vila-Freyer, *Biserial algebras*. Doctoral Thesis, Oxford 1994.

[Back to Overview Biserial 7.](#)

7.3. Special biserial and string algebras.

7.3.1. Special biserial algebras.

A basic algebra $A = KQ/I$ is **special biserial** provided the following hold:

- (i) Q is biserial.
- (ii) Let $a_1, a_2, b \in Q_1$ with $a_1 \neq a_2$ and $s(a_1) = s(a_2) = t(b)$, then $|\{a_1b, a_2b\} \cap I| \geq 1$.

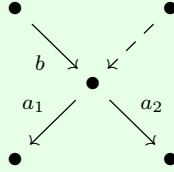

- (iii) Let $a_1, a_2, b \in Q_1$ with $a_1 \neq a_2$ and $t(a_1) = t(a_2) = s(b)$, then $|\{ba_1, ba_2\} \cap I| \geq 1$.

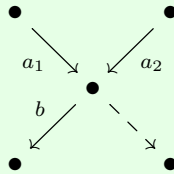

Each special biserial algebra is a biserial algebra.

The converse is usually wrong.

There is a combinatorial description of all finite-dimensional indecomposable modules over special biserial algebras, see [BR87, WW85]. (They are either string modules or band modules or non-uniserial projective-injective modules.) The Auslander-Reiten quivers of special biserial algebras can also be constructed combinatorially, see [BR87].

To be expanded...

Special biserial algebras appear in numerous different contexts. They also serve as a commonly used test class for conjectures.

Examples of special biserial algebras:

- (i) Let $A = KQ/I$ where Q is the quiver

$$1 \begin{array}{c} \xrightarrow{a} \\ \xrightarrow{c} \end{array} 2 \begin{array}{c} \xrightarrow{b} \\ \xrightarrow{d} \end{array} 3$$

and I is generated by $\{ba - dc, da, bc\}$. The indecomposable projectives are

$$P(1) = \begin{array}{ccc} & 1 & \\ a \swarrow & & \searrow c \\ 2 & & 2 \\ & b \searrow & \swarrow d \\ & 3 & \end{array} \quad P(2) = \begin{array}{ccc} & 2 & \\ d \swarrow & & \searrow b \\ 3 & & 3 \end{array} \quad P(3) = 3$$

(ii) Let $n \geq 1$, and let $A = KQ/I$ where Q is the quiver

$$a \circlearrowleft 1 \circlearrowright b$$

and I is generated by $\{a^2, b^2, (ab)^n - (ba)^n\}$.

(iii) For $q \in K^*$ let $A_q = KQ/I$ where Q is the quiver

$$a \circlearrowleft 1 \circlearrowright b$$

and I is generated by $\{a^2, b^2, ab - qba\}$. For $q, q' \in K^*$ we have $A_q \cong A_{q'}$ if and only if $q' \in \{q, q^{-1}\}$.

Theorem 7.6 (Skowroński, Waschbüsch [SW83]). *Let K be algebraically closed. Representation-finite biserial K -algebras are special biserial, up to Morita equivalence.*

Theorem 7.7 (Wald, Waschbüsch [WW85, Theorem 1.4]). *Let K be algebraically closed. Each special biserial K -algebra is isomorphic to a factor algebra of some symmetric special biserial algebra.*

7.3.2. String algebras.

A basic algebra $A = KQ/I$ is a **string algebra** if the following hold:

- (i) Q is biserial.
- (ii) Let $a_1, a_2, b \in Q_1$ with $a_1 \neq a_2$ and $s(a_1) = s(a_2) = t(b)$, then $|\{a_1b, a_2b\} \cap I| \geq 1$.
- (iii) Let $a_1, a_2, b \in Q_1$ with $a_1 \neq a_2$ and $t(a_1) = t(a_2) = s(b)$, then $|\{ba_1, ba_2\} \cap I| \geq 1$.
- (iv) I is generated by a set of paths in Q .

Obviously, each string algebra is a special biserial algebra.

The converse is usually wrong.

Examples of string algebras:

- (i) Basic Nakayama algebras KQ/I .

(ii) For $n \geq 2$ let $A = KQ/I$ where Q is the quiver

$$1 \xrightarrow{a} 2 \begin{array}{c} \curvearrowright \\ \curvearrowleft \end{array} b$$

and I is generated by $\{ba, b^n\}$.

(iii) Let $n \geq 2$, and let $A = KQ/I$ where Q is the quiver

$$a \begin{array}{c} \curvearrowleft \\ \curvearrowright \end{array} 1 \begin{array}{c} \curvearrowright \\ \curvearrowleft \end{array} b$$

and I is generated by $\{a^n, b^n, ab, ba\}$.

For a string algebra A and $X, Y \in \text{ind}(A)$, there is a combinatorial construction of a basis of $\text{Hom}_A(X, Y)$, see [CB89] and [Kr91].

To be expanded...

7.3.3. From special biserial to string algebras. A special biserial algebra A is a string algebra if and only if there is no indecomposable non-uniserial projective-injective A -module.

Let $A = KQ/I$ be special biserial, and let ${}_A A = P(1) \oplus \cdots \oplus P(n)$ with $P(i)$ indecomposable projective for $1 \leq i \leq n$. Let

$$J := \bigoplus_i \text{soc}(P(i))$$

where i runs over all indices such that $P(i)$ is non-uniserial projective-injective. Then J is a two-sided ideal in A , and A/J is a string algebra. We get an obvious embedding $\text{mod}(A/J) \rightarrow \text{mod}(A)$. The only indecomposable finite-dimensional A -modules, which are not A/J -modules, are the indecomposable non-uniserial projective-injectives. However, the homological behaviour of A and A/J might change dramatically.

In terms of quivers with relations it is quite easy to describe J . Namely, J is generated by the union of all sets $\{p, q\}$ where p and q are paths of length at least two in Q such that $s(p) = s(q)$, $t(p) = t(q)$ and $p - \lambda q \in I$ for some $\lambda \in K^*$.

LITERATURE – SPECIAL BISERIAL AND STRING ALGEBRAS

- [BR87] M.C.R. Butler, C.M. Ringel, *Auslander-Reiten sequences with few middle terms and applications to string algebras*, Comm. Algebra 15 (1987), no. 1-2, 145–179.
(This contains the classification of finite-dimensional indecomposable modules over special biserial algebras. The classification is obtained via functorial filtrations. There is also a combinatorial description of the Auslander-Reiten quiver of special biserial algebras.)
- [CB89] W. Crawley-Boevey, *Maps between representations of zero-relation algebras*. J. Algebra 126 (1989), no. 2, 259–263.
- [GP68] I. M. Gelfand and V. A. Ponomarev. *Indecomposable representations of the Lorentz group*. Russian Mathematical Surveys, 23(2):1–58, 1968.
(Deals with the special case $K\langle x, y \rangle / (ab, ba, a^n, b^n)$. All fundamental ideas for classifying the finite-dimensional indecomposable modules over special biserial algebras can already be found here.)
- [Kr91] H. Krause, *Maps between tree and band modules*. J. Algebra 137 (1991), no. 1, 186–194.

- [R75] C.M. Ringel, *The indecomposable representations of the dihedral 2-groups*. Math. Ann. 214 (1975), 19–34.
(Deals with the special case $K\langle x, y \rangle / (a^2, b^2, (ab)^n - (ba)^n)$. Explains the functorial filtration method.)
- [SW83] S. Skowroński, J. Waschbüsch, *Representation-finite biserial algebras*. J. Reine Angew. Math. 345 (1983), 172–181.
- [WW85] B. Wald, J. Waschbüsch, *Tame biserial algebras*, J. Algebra 95 (1985), no. 2, 480–500.
(This contains the first classification of finite-dimensional indecomposable modules over special biserial algebras. The classification is obtained via coverings and push-down functors.)

Back to Overview Biserial 7.

7.4. Gentle algebras.

A basic algebra $A = KQ/I$ is a **gentle algebra** if the following hold:

- (i) Q is biserial.
- (ii) Let $a_1, a_2, b \in Q_1$ with $a_1 \neq a_2$ and $s(a_1) = s(a_2) = t(b)$, then $|\{a_1b, a_2b\} \cap I| = 1$.
- (iii) Let $a_1, a_2, b \in Q_1$ with $a_1 \neq a_2$ and $t(a_1) = t(a_2) = s(b)$, then $|\{ba_1, ba_2\} \cap I| = 1$.
- (iv) I is generated by a set of paths of length 2 in Q .

Obviously, each gentle algebra is a string algebra.

The converse is usually wrong.

Gentle algebras and string algebras are important classes of monomial algebras. They generalize the path algebras of quivers of type \mathbb{A}_n and $\widetilde{\mathbb{A}}_n$. They also appear in surprisingly many different contexts, and they also serve as a test class for new ideas and conjectures.

Examples of gentle algebra:

- (i) Let $A = KQ/I$ where Q is the quiver

$$1 \begin{array}{c} \xrightarrow{a} \\ \xrightarrow{c} \end{array} 2 \begin{array}{c} \xrightarrow{b} \\ \xrightarrow{d} \end{array} 3$$

and I is generated by $\{da, bc\}$. The indecomposable projectives are

$$P(1) = \begin{array}{c} 1 \\ \swarrow a \quad \searrow c \\ 2 \quad \quad 2 \\ \downarrow b \quad \downarrow d \\ 3 \quad \quad 3 \end{array} \quad P(2) = \begin{array}{c} 2 \\ \swarrow d \quad \searrow b \\ 3 \quad \quad 3 \end{array} \quad P(3) = 3$$

(ii) Let $A = KQ/I$ where Q is the quiver

$$1 \begin{array}{c} \curvearrowright \\ \curvearrowleft \end{array} a$$

and I is generated by a^2 . Besides $A = K$ this is the only local gentle algebra.

In part (iii) of the following theorem, one extends the definition of a special biserial algebra to infinite quivers in the obvious way.

Theorem 7.8 ([R97, Sch99a]). *The following are equivalent:*

- (i) A is a gentle algebra.
- (ii) The trivial extension algebra $T(A)$ is special biserial.
- (iii) The repetitive algebra \widehat{A} is a special biserial algebra.

Theorem 7.9 ([Sch99b]). *Let A be a gentle algebra, and let $M \in \text{mod}(A)$ with $\text{Ext}_A^1(M, M) = 0$. Then $\text{End}_A(M)$ is a gentle algebra.*

Recall that two finite-dimensional K -algebras A and B are **derived equivalent** if there is a triangle equivalence

$$D^b(\text{mod}(A)) \rightarrow D^b(\text{mod}(B)).$$

Theorem 7.10 ([SchZ03]). *Let A and B be finite-dimensional basic K -algebras which are derived equivalent. If A is a gentle algebra, then B is a gentle algebra*

To each gentle algebra A one can associate a triangulated marked surface. For $X, Y \in \text{ind}(A)$ there are curves γ_X and γ_Y on this surface such that (roughly speaking) $\dim \text{Hom}_A(X, Y)$ and $\dim \text{Ext}_A^1(X, Y)$ can be computed by counting intersections of these curves.

Using this approach, there is a recent concerted effort to get a derived equivalence classification of gentle algebras. Despite a lot of progress it still seems to be difficult to decide if two given gentle algebras are derived equivalent or not.

To be continued...

LITERATURE – GENTLE ALGEBRAS

- [APS19] C. Amiot, P.-G. Plamondon, S. Schroll, *A complete derived invariant for gentle algebras via winding numbers and Arf invariants*. arXiv:1904.02555
- [ABCP10] I. Assem, T. Brüstle, G. Charbonneau-Jodoin, P.-G. Plamondon, *Gentle algebras arising from surface triangulations*. Algebra Number Theory 4 (2010), no. 2, 201–229.
- [BGS04] G. Bobiński, C. Geiß, A. Skowroński, *Classification of discrete derived categories*. Cent. Eur. J. Math. 2 (2004), no. 1, 19–49.

- [B16] R. Bocklandt, *Noncommutative mirror symmetry for punctured surfaces*. With an appendix by Mohammed Abouzaid. *Trans. Amer. Math. Soc.* 368 (2016), no. 1, 429–469.
- [BD18] I. Burban, Y. Drozd, *Non-commutative nodal curves and derived tame algebras*. arXiv:1805.05174
- [BD17] I. Burban, Y. Drozd, *On the derived categories of gentle and skew-gentle algebras: homological algebra and matrix problems*. arXiv:1706.08358
- [CS20] W. Chang, S. Schroll, *A geometric realization of silting theory for gentle algebras*. arXiv:2012.12663
- [DK18] T. Dyckerhoff, M. Kapranov, *Triangulated surfaces in triangulated categories*. *J. Eur. Math. Soc.* 20 (2018), no. 6, 1473–1524.
- [AG08] D. Avella-Alaminos, C. Geiß, *Combinatorial derived invariants for gentle algebras*. *J. Pure Appl. Algebra* 212 (2008), no. 1, 228–243.
- [GLS16] C. Geiß, D. Labardini-Fragoso, J. Schröer, *The representation type of Jacobian algebras*. *Adv. Math.* 290 (2016), 364–452.
- [GLS20] C. Geiß, D. Labardini-Fragoso, J. Schröer, *Schemes of modules over gentle algebras and laminations of surfaces*. arXiv:2005.01073
- [GR05] C. Geiß, I. Reiten, *Gentle algebras are Gorenstein*. In *Representations of algebras and related topics*, Fields Institute Communications, Volume 45, pp. 129–133 (American Mathematical Society, Providence, RI, 2005).
- [HKK17] F. Haiden, L. Katzarkov, M. Kontsevich, *Flat surfaces and stability structures*. *Publ. Math. Inst. Hautes Etudes Sci.* 126 (2017), 247–318.
- [IQZ20] A. Ikeda, Y. Qiu, Y. Zhou, *Graded decorated marked surfaces: Calabi-Yau- \mathbb{X} -categories of gentle algebras*. arXiv:2006.00009
- [L09] D. Labardini-Fragoso, *Quivers with potentials associated to triangulated surfaces*. *Proc. Lond. Math. Soc.* (3) 98 (2009), no. 3, 797–839.
- [LP20] Y. Lekili, A. Polishchuk, *Derived equivalences of gentle algebras via Fukaya categories*. *Math. Ann.* 376 (2020), no. 1–2, 187–225.
- [O19] S. Opper, *On auto-equivalences and complete derived invariants of gentle algebras*. arXiv:1904.04859
- [O20] S. Opper, *Spherical objects, transitivity and auto-equivalences of Kodaira cycles via gentle algebras*. arXiv:2011.08288
- [OPS18] S. Opper, P.-G. Plamondon, S. Schroll, *A geometric model for the derived category of gentle algebras*. arXiv:1801.09659
- [R97] C.M. Ringel, *The repetitive algebra of a gentle algebra*, *Bol. Soc. Mat. Mexicana* (3) 3 (1997), no. 2, 235–253.
- [Sch99a] J. Schröer, *On the quiver with relations of a repetitive algebra*, *Arch. Math. (Basel)* 72 (1999), no. 6, 426–432.
- [Sch99b] J. Schröer, *Modules without self-extensions over gentle algebras*. *J. Algebra* 216 (1999), no. 1, 178–189.
- [SchZ03] J. Schröer, A. Zimmermann, *Stable endomorphism algebras of modules over special biserial algebras*, *Math. Z.* 244 (2003), no. 3, 515–530.
- [S15] S. Schroll, *Trivial extensions of gentle algebras and Brauer graph algebras*. *J. Algebra* 444 (2015), 183–200.
- [V01] D. Vossieck, *The algebras with discrete derived category*. *J. Algebra* 243 (2001), no. 1, 168–176.

Back to Overview Biserial 7.

7.5. Clannish and skewed-gentle algebras.

7.5.1. *Clannish algebras.* Let $Q = (Q_0, Q_1, s, t)$ be a quiver. A **loop** in Q is an arrow $a \in Q_1$ with $s(a) = t(a)$.

We fix a subset $Q_1^{\text{sp}} \subseteq \{a \in Q_1 \mid s(a) = t(a)\}$ of **special loops** of Q . Let $Q_1^{\text{ord}} := Q_1 \setminus Q_1^{\text{sp}}$ be the set of **ordinary arrows** of Q .

Let S be the ideal in KQ generated by the elements $\{a^2 - a \mid a \in Q_1^{\text{sp}}\}$.

Let I be an ideal in KQ . Then KQ/I is a **clannish algebra** if the following hold:

- (C1) Q is biserial.
- (C2) For arrows $a_1, a_2 \in Q_1$ and $b \in Q_1^{\text{ord}}$ with $a_1 \neq a_2$ and $s(a_1) = s(a_2) = t(b)$ we have $|\{a_1b, a_2b\} \cap I| \geq 1$.
- (C3) For arrows $a_1, a_2 \in Q_1$ and $b \in Q_1^{\text{ord}}$ with $a_1 \neq a_2$ and $t(a_1) = t(a_2) = s(b)$ we have $|\{ba_1, ba_2\} \cap I| \geq 1$.
- (C4) There is an ideal $J \subseteq KQ_{\geq 2}$ such that $I = J + S$.
- (C5) There exists some $m \geq 2$ such that each path $a_1a_2 \dots a_m$ of length m in Q which does not contain a subpath $a_i a_{i+1} = aa$ with $a \in Q_1^{\text{sp}}$ for some $1 \leq i \leq m - 1$ is contained in I .

Note that the ideal I appearing in the above definition is not an admissible ideal in case Q_1^{sp} is non-empty. In any case, there exists a quiver Q' and an admissible ideal I' in the path algebra KQ' such that $KQ/I \cong KQ'/I'$.

A finite-dimensional K -algebra which is Morita equivalent to a clannish algebra is also called a **clannish algebra**.

The definition of a clannish algebra is due to Crawley-Boevey [CB89]. Crawley-Boevey's definition varies slightly from ours. He assumes additionally that the ideal J is generated by zero-relations. On the other hand, we assume additionally condition (C5) implying that clannish algebras are finite-dimensional. We also refer to the closely related definition of a *quasi-clannish algebra* due to de la Peña and Geiß [DG99].

There is a combinatorial description of all finite-dimensional indecomposable modules over clannish algebras, see [CB89, D00]. The Auslander-Reiten quiver of clannish algebras can also be constructed combinatorially, see [DG99].

If one considers special biserial algebras as natural generalizations of path algebras of quivers of type \mathbb{A}_n and $\tilde{\mathbb{A}}_n$, then clannish algebras are in the same sense natural generalizations of path algebras of quivers of type \mathbb{D}_n and $\tilde{\mathbb{D}}_n$.

Proposition 7.11 ([CB89, D00]). *Let K be algebraically closed. Then clannish K -algebras are tame algebras.*

7.5.2. Skewed-gentle algebras.

A clannish algebra KQ/I is a **skewed-gentle algebra** provided in addition to (C1), ..., (C5) also the following hold:

- (C6) For arrows $a_1, a_2 \in Q_1$ and $b \in Q_1^{\text{ord}}$ with $a_1 \neq a_2$ and $s(a_1) = s(a_2) = t(b)$ we have $a_1b \notin I$ or $a_2b \notin I$.
- (C7) For arrows $a_1, a_2 \in Q_1$ and $b \in Q_1^{\text{ord}}$ with $a_1 \neq a_2$ and $t(a_1) = t(a_2) = s(b)$ and we have $ba_1 \notin I$ or $ba_2 \notin I$.
- (C8) The ideal J appearing in (C4) is generated by a set of paths of length two.

A finite-dimensional K -algebra which is Morita equivalent to a skewed-gentle algebra is also called a **skewed-gentle algebra**.

The definition of a clannish algebra can be extended to infinite quivers in the obvious way.

Proposition 7.12 ([DG99]). *If A is a skewed-gentle algebra, then the repetitive algebra \widehat{A} is a clannish algebra,*

Example: Let Q be the quiver

$$\varepsilon_1 \circlearrowleft 1 \longleftarrow 2 \longleftarrow 3 \circlearrowright \varepsilon_3$$

with $Q_1^{\text{sp}} := \{\varepsilon_1, \varepsilon_3\}$, and let I be the ideal in KQ generated by $\varepsilon_i^2 - \varepsilon_i$ with $i = 1, 3$. Let Q' be the quiver

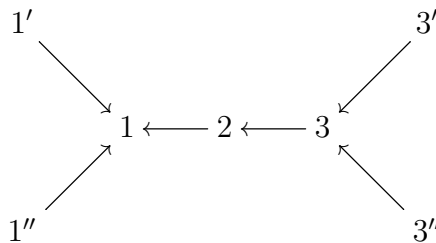

Then KQ/I and KQ' are isomorphic skewed-gentle algebras.

LITERATURE – CLANNISH AND SKEWED-GENTLE ALGEBRAS

- [AB19] C. Amiot, T. Brüstle, *Derived equivalences between skew-gentle algebras using orbifolds*. arXiv:1912.04367
- [BH07] C. Bessenrodt, T. Holm, *q-Cartan matrices and combinatorial invariants of derived categories for skewed-gentle algebras*. Pacific J. Math. 229 (2007), no. 1, 25–47.
- [CB89] W. Crawley-Boevey, *Functorial filtrations II: Clans and the Gelfand problem*. J. London Math. Soc 40 (1989), 9–30.
- [LSV20] D. Labardini-Fragoso, S. Schroll, Y. Valdivieso, *Derived categories of skew-gentle algebras and orbifolds*. arXiv:2006.05836
- [DG99] J.A. de la Peña, C. Geiß, *Auslander-Reiten components for clans*. Bol. Soc. Mat. Mexicana (3) 5 (1999), no. 2, 307–326.
- [D00] B. Deng, *On a problem of Nazarova and Roiter*. Comment. Math. Helv. 75 (2000), no. 3, 368–409.

Back to Overview [Biserial 7](#).

8. Multiplicative basis algebras

§8 Multiplicative basis algebras:

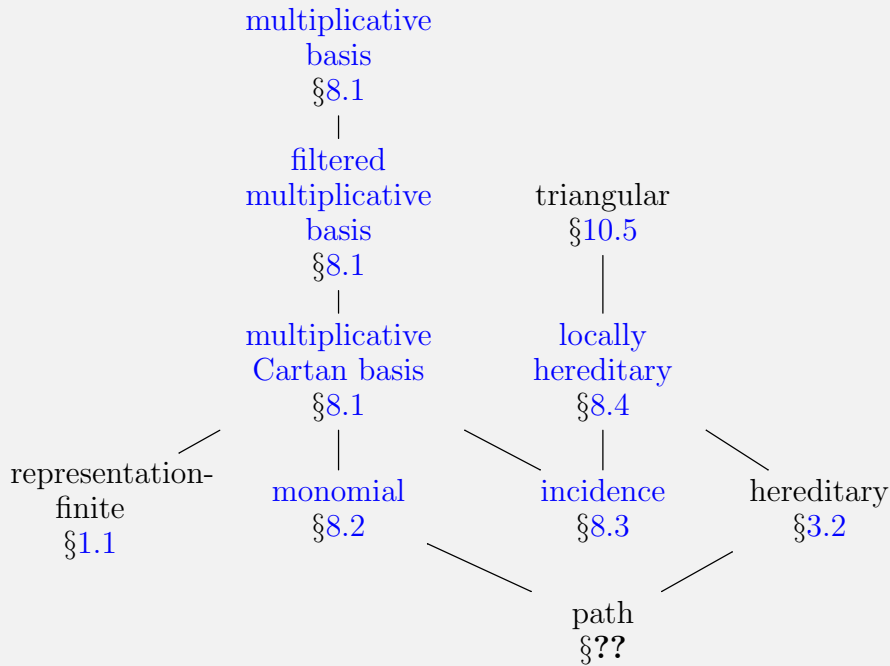

[Back to Overview Metaclasses 1.](#)

8.1. **Multiplicative basis algebras.** Let A be a finite-dimensional K -algebra.

A K -basis B of A is a **multiplicative basis** if the following holds:

(M1) $bb' \in B \cup \{0\}$ for all $b, b' \in B$.

Examples of algebras with a multiplicative basis are matrix algebras $M_n(K)$, group algebras KG of finite groups G , path algebras KQ of acyclic quivers Q , monomial algebras KQ/I and incidence algebras $I(P)$ of finite posets P .

Example: For $q \in K$ let $A_q = KQ/I_q$ where Q is the quiver

$$a \begin{array}{c} \curvearrowright \\ \curvearrowleft \end{array} 1 \begin{array}{c} \curvearrowright \\ \curvearrowleft \end{array} b$$

and I_q is generated by $\{a^2, b^2, ab - qba\}$. If $q(q-1)(q^2-q+1) \neq 0$, then A_q does not have a multiplicative basis. This example is taken from [BGRS85].

A K -basis B of A is a **filtered multiplicative basis** if the following hold:

(M1) $bb' \in B \cup \{0\}$ for all $b, b' \in B$.

(M2) $B \cap J(A)$ is a K -basis of $J(A)$.

Here $J(A)$ denotes the Jacobson radical of A .

There are examples of a finite groups G such that KG does not have a filtered multiplicative basis, see [P87]. For some positive examples, we refer to [B00].

A K -basis B of A is a **multiplicative Cartan basis** if the following hold:

- (M1) $bb' \in B \cup \{0\}$ for all $b, b' \in B$.
- (M2) $B \cap J(A)$ is a K -basis of $J(A)$.
- (M3) B contains a complete set of primitive pairwise orthogonal idempotents e_1, \dots, e_n .

If $A = KQ/I$ is a basic algebra, and B is a multiplicative Cartan basis of A as in the definition above, then B is the disjoint union of $B \cap J(A)$ and $\{e_1, \dots, e_n\}$.

I'm guessing that the existence of a filtered multiplicative basis implies the existence of a multiplicative Cartan basis. But I didn't check it.

Almost by definition, a multiplicative Cartan basis of A provides a basis of each indecomposable projective and each indecomposable injective A -module.

Let $A = KQ/I$ be a basic algebra. A path p of length at least 2 with $a \in I$ is a **zero relation**. For two paths $p \neq q$ of length at least 2 with $s(p) = s(q)$ and $t(p) = t(q)$ and $p - q \in I$, the element $p - q$ is a **commutativity relation**.

The next result is similar to [G00, Theorem 2.3] and is proved in a similar way.

Proposition 8.1. *For a basic algebra $A = KQ/I$ the following are equivalent.*

- (i) $A \cong KQ/I'$ where I' is an admissible ideal which is generated by zero relations and commutativity relations.
- (ii) A has a multiplicative Cartan basis.

The following result is a milestone. The proof is quite involved.

Theorem 8.2 ([BGRS85]). *Let K be algebraically closed. If A is representation-finite, then A has a multiplicative Cartan basis.*

Corollary 8.3. *Let K be algebraically closed. For each $d \geq 1$ there exist only finitely many d -dimensional representation-finite K -algebras, up to isomorphism.*

Problem 8.4 ([R02, Problem 1]). *Determine all minimal algebras without a multiplicative Cartan basis.*

One can modify the three definition above by replacing condition (M1) by the condition

$$bb' \in \{\lambda c \mid \lambda \in K, c \in B\}$$

for all $b, b' \in B$.

Green [G00] defined and studied **ordered multiplicative bases**. We won't repeat his definition here.

LITERATURE – MULTIPLICATIVE BASIS ALGEBRAS

- [BGRS85] R. Bautista, P. Gabriel, A.V. Roiter, L. Salmerón, *Representation-finite algebras and multiplicative bases*. Invent. Math. 81 (2) (1985) 217–285.
- [B00] V. Bovdi, *On a filtered multiplicative basis of group algebras*. Arch. Math. (Basel) 74 (2000), no. 2, 81–88.
- [G00] E. Green, *Multiplicative bases, Gröbner bases, and right Gröbner bases*. Symbolic computation in algebra, analysis, and geometry (Berkeley, CA, 1998). J. Symbolic Comput. 29 (2000), no. 4-5, 601–623.
- [P87] L. Paris, *Some examples of group algebras without filtered multiplicative basis*. Enseign. Math. (2) 33 (1987), no. 3-4, 307–314.
- [R02] C.M. Ringel, *Combinatorial representation theory history and future*. In: Representations of algebra. Vol. I, II, 122–144, Beijing Norm. Univ. Press, Beijing, 2002.

Back to Overview §8 Multiplicative.

8.2. Monomial algebras.

A basic algebra $A = KQ/I$ is a **monomial algebra** if I can be generated by a set of paths in Q .

Here are some classes of monomial algebras:

- finite-dimensional path algebras;
- basic Nakayama algebras;
- string algebras;
- tree algebras.

Proposition 8.5. *Let $A = KQ/I$ be a monomial algebra. Then*

$$\{p + I \mid p \text{ is a path in } Q \text{ with } p \notin I\}$$

is a K -basis of A .

This multiplicative basis (see Section 8.1) implies that the construction of indecomposable projective and indecomposable injective modules over a monomial algebra becomes purely combinatorial. We illustrate this with an example.

Example: Let Q be the quiver

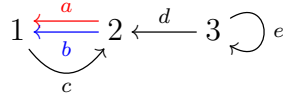

and let $A = KQ/I$ with I generated by

$$\{ac, bc, ad, cbd, de^2, e^3\}.$$

The indecomposable projectives $P(1), P(2), P(3)$ are

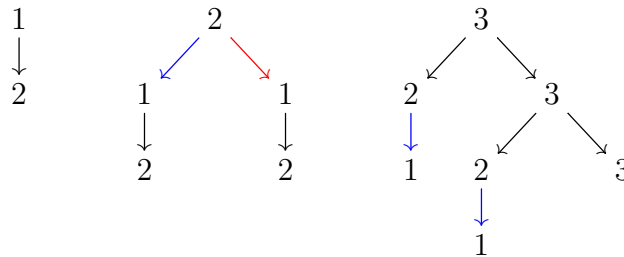

and the indecomposable injectives $I(1), I(2), I(3)$ are

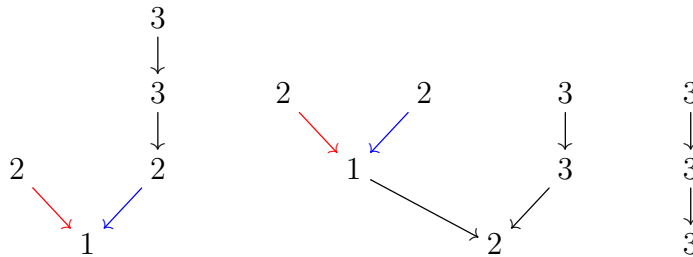

It is an open problem to find a characterization of the class of monomial algebras which is independent of generators and relations. We refer to [BG99] for an attempt in this direction. Maybe such a characterization does not exist, and maybe monomial algebras are not a meaningful class of algebras, except that they are easy to handle (concerning certain aspects, like the construction of projectives and projective resolutions, etc). Monomial algebras are also a commonly used test class for conjectures and new phenomena. Various important results on monomial algebras can be found in [ZH91].

LITERATURE – MONOMIAL ALGEBRAS

[BG99] M.J. Bardzell, E. Green, *An invariant characterization of monomial algebras*. Comm. Algebra 27 (1999), no. 5, 2331–2344.
 [ZH91] B. Zimmermann-Huisgen, *Predicting syzygies over monomial relations algebras*. Manuscripta Math. 70 (1991), no. 2, 157–182.

8.3. Incidence algebras. Let P be a finite poset. The main reference for this section is Simson's beautiful book [Si92].

8.3.1. *Representations of P .* For $i, j \in P$ we call

$$[i, j] := \{k \in P \mid i \leq k \leq j\}$$

an **interval** in P .

A **representation** of the poset P is a tuple $V = (V_*, V_i)_{i \in P}$ of K -vector spaces such that the following hold:

- (i) $V_i \subseteq V_*$ for all $i \in P$.
- (ii) For each non-empty interval $[i, j]$ in P we have $V_i \subseteq V_j$.

Such a representation V is also called a **P -space**.

For representations $V = (V_*, V_i)$ and $W = (W_*, W_i)$ of P a **morphism** $V \rightarrow W$ is a K -linear map $f: V_* \rightarrow W_*$ such that

$$f(V_i) \subseteq W_i$$

for all $i \in P$.

In this case, for $i \in P$ let $f_i: V_i \rightarrow W_i$ be the restriction of f . The morphism $f: V \rightarrow W$ is an **isomorphism** provided f and all f_i are isomorphisms of K -vector spaces.

A representation (V_*, V_i) is **finite-dimensional** if $\dim(V_*) < \infty$.

Let $\text{rep}(P)$ be the category of finite-dimensional representations of P .

One can define direct sums of representations of P in the obvious way. This leads to the notion of an indecomposable representation of P .

Proposition 8.6. $\text{rep}(P)$ is a K -linear Krull-Remak-Schmidt category.

The poset P is **representation-finite** if there are only finitely many indecomposable representations in $\text{rep}(P)$, up to isomorphism.

Let P^* be the poset obtained from P by adding a new element $*$ to P such that $i < *$ for all $i \in P$.

The **Tits form** of P is defined by

$$q_P: \mathbb{Z}^{P^*} \rightarrow \mathbb{Z}$$

$$x \mapsto \sum_{i \in P^*} x_i^2 + \sum_{\substack{i > j \\ i, j \in P}} x_i x_j - \sum_{i \in P} x_i x_*$$

This is a quadratic form.

A quadratic form $q: \mathbb{Z}^n \rightarrow \mathbb{Z}$ is **weakly positive** (resp. **weakly non-negative**) if $q(x) > 0$ (resp. $q(x) \geq 0$) for all $x \in \mathbb{N}^n$.

For $n \geq 1$ let (n) be the poset $1 < 2 < \dots < n$. By (n_1, \dots, n_t) we denote the disjoint union of posets (n_i) . Let N be the poset $1 < 3 > 2 < 4$, and let (N, n) be the disjoint union of N and (n) .

A **subposet** of a poset P is a subset U of P together with the induced partial order on U .

Theorem 8.7 (Kleiner [K72]). *For a poset P the following are equivalent:*

- (i) P is representation-finite.
- (ii) q_P is weakly positive.
- (iii) P does not contain any subposet isomorphic to one of the posets $(1, 1, 1, 1)$, $(2, 2, 2)$, $(1, 3, 3)$, $(1, 2, 5)$, $(N, 4)$.

For $V = (V_*, V_i) \in \text{rep}(P)$ the **coordinate vector**

$$\mathbf{cdn}(V) := (c_*, c_i)_{i \in P} \in \mathbb{Z}^{P^*}$$

of V is defined by $c_* := \dim(V_*)$ and

$$c_i := \dim \left(V_i / \sum_{k < i} V_k \right)$$

for $i \in P$.

Theorem 8.8 (Drozd [D74]). *If P is representation-finite, then there is a bijection*

$$\{V \in \text{rep}(P) \mid V \text{ is indecomposable}\} / \cong \longrightarrow \{x \in \mathbb{Z}^{P^*} \mid q_P(x) = 1\}$$

$$V \mapsto \mathbf{cdn}(V).$$

8.3.2. *Incidence algebras.* For $a, b \in P$ we call

$$[a, b] := \{x \in P \mid a \leq x \leq b\}$$

an **interval** in P .

The **incidence algebra** $I(P)$ of the finite poset P has a K -basis given by the set of non-empty intervals in P . The multiplication is defined by

$$[c, d] \cdot [a, b] := \begin{cases} [a, d] & \text{if } b = c, \\ 0 & \text{otherwise.} \end{cases}$$

Warning: In the literature, the incidence algebra is often defined as $I(P)^{\text{op}}$, i.e. by

$$[a, b] \cdot [c, d] := \begin{cases} [a, d] & \text{if } b = c, \\ 0 & \text{otherwise.} \end{cases}$$

There are the usual issues at work (left versus right modules and how to compose arrows in path algebras).

Let Q be the quiver with vertex set P and an arrow $a \rightarrow b$ for each interval $[a, b]$ in P with $|[a, b]| = 2$. Let I be the ideal in KQ generated by all commutativity relations $p - q$ where p and q are paths in Q with $s(p) = s(q)$ and $t(p) = t(q)$. It follows that I is an admissible ideal.

We have

$$I(P) \cong KQ/I.$$

One often just identifies $I(P)$ and KQ/I .

Example: Let P be the poset described by the following Hasse diagram (for $x < y$, x is drawn below y):

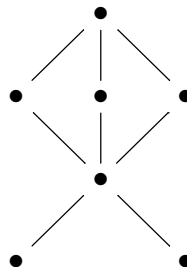

Then $I(P) = KQ/I$ where Q is the quiver

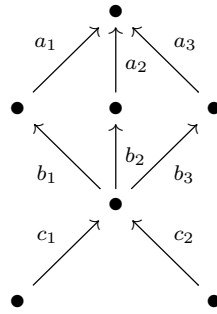

and I is generated by

$$\{a_i b_i - a_j b_j, a_i b_i c_k - a_j b_j c_k \mid 1 \leq i, j \leq 3, k = 1, 2\}.$$

Note that most of these relations are redundant, e.g. the relations involving c_k follow already from the other relations.

Let P^* be the poset obtained from P by adding an element $*$ with $i < *$ for all $i \in P$.

Let $I(P^*) = KQ/I$, and let $e_* \in I(P^*)$ be the idempotent associated to the vertex $*$ of Q .

There is an obvious surjective algebra homomorphism

$$I(P^*) \rightarrow I(P)$$

with kernel $I(P^*)e_*I(P^*) = e_*I(P^*)$. This yields a functor

$$\text{mod}(I(P)) \rightarrow \text{mod}(I(P^*))$$

which we treat as an inclusion.

There is also a functor

$$\text{mod}(I(P^*)) \rightarrow \text{mod}(I(P))$$

which send X to X/e_*X .

There is an obvious functor

$$\text{rep}(P) \rightarrow \text{mod}(I(P^*))$$

which we also treat like an inclusion.

Example: Let P be the poset with Hasse diagram

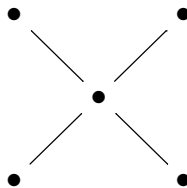

Then P is representation-finite, but $I(P)$ and $I(P^*)$ are representation-infinite.

Let

$$\text{mod}_{\text{sp}}(I(P^*)) := \{X \in \text{mod}(I(P^*)) \mid \text{soc}(X) \text{ is projective}\}.$$

The modules in $\text{mod}_{\text{sp}}(I(P^*))$ are called **socle projective**.

Note that $P(*)$ is the only simple projective $I(P^*)$ -module, up to isomorphism. One easily checks that $\text{rep}(P)$ and $\text{mod}_{\text{sp}}(I(P^*))$ are equivalent categories. In contrast to $\text{mod}_{\text{sp}}(I(P^*))$, the subcategory $\text{rep}(P)$ of $\text{mod}(I(P^*))$ is not closed under isomorphisms.

Proposition 8.9. *Let $I(P^*) = KQ/I$. Then*

$$\begin{aligned} \text{mod}_{\text{sp}}(I(P^*)) &= \{V \in \text{mod}(I(P^*)) \mid V_{\text{out}(i)} \text{ is injective for all } i \in P\} \\ &= \{V \in \text{mod}(I(P^*)) \mid V_a \text{ is injective for all } a \in Q_1\}. \end{aligned}$$

Here we interpret $I(P^*)$ -modules as representations $V = (V_i, V_a)$ of the quiver Q . For $i \in P$ we have

$$V_{\text{out}(i)} := \begin{pmatrix} V_{a_1} \\ \vdots \\ V_{a_t} \end{pmatrix} : V_i \rightarrow \bigoplus_{k=1}^t V_{t(a_k)}$$

where a_1, \dots, a_t are the arrows starting in i . The first equality in the proposition follows almost directly from the definition of $\text{mod}_{\text{sp}}(I(P^*))$. The second equality uses the commutativity relations in the definition of $I(P^*)$.

Proposition 8.10. *The subcategory $\text{mod}_{\text{sp}}(I(P^*))$ of $\text{mod}(I(P^*))$ is additive, closed under extensions and closed under kernels.*

Let

$$\text{prinj}(I(P^*)) := \{X \in \text{mod}(I(P^*)) \mid X/e_*X \in \text{proj}(I(P))\}$$

be the category of **prinjective** $I(P^*)$ -modules.

It follows that $X \in \text{mod}(I(P^*))$ is prinjective if and only if its minimal projective resolution is of the form

$$0 \rightarrow P(*)^m \rightarrow P \rightarrow X \rightarrow 0$$

for some $m \geq 0$.

All arrows in the following diagram can be interpreted as inclusions:

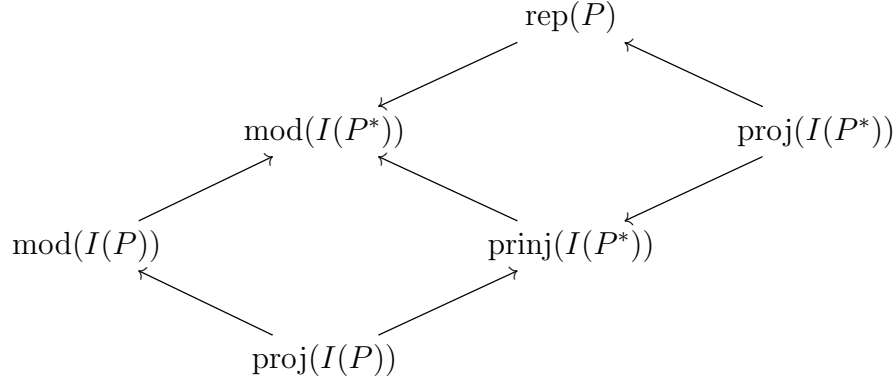

For a proof of the following result we refer to [Si92].

Theorem 8.11. *The following hold:*

- (i) *The subcategory $\text{prinj}(I(P^*))$ of $\text{mod}(I(P^*))$ is additive, closed under extensions and closed under kernels of epimorphisms.*
- (ii) *$\text{prinj}(I(P^*))$ is hereditary, i.e.*

$$\text{Ext}_{I(P^*)}^2(X, Y) = 0$$

for all $X, Y \in \text{prinj}(I(P^))$.*

- (iii) *$\text{prinj}(I(P^*))$ has Auslander-Reiten sequences.*

Consider the bilinear form

$$\begin{aligned}
 \langle -, ? \rangle_P: \mathbb{Z}^{P^*} \times \mathbb{Z}^{P^*} &\rightarrow \mathbb{Z} \\
 (x, y) &\mapsto \sum_{i \in P^*} x_i y_i + \sum_{\substack{i > j \\ i, j \in P}} x_i y_j - \sum_{i \in P} x_i y_*.
 \end{aligned}$$

Theorem 8.12. *For $X, Y \in \text{prinj}(I(P^*))$ we have*

$$\langle \mathbf{cdn}(X), \mathbf{cdn}(Y) \rangle_P = \dim \text{Hom}_{I(P^*)}(X, Y) - \dim \text{Ext}_{I(P^*)}^1(X, Y).$$

Let

$$F: \text{mod}(I(P^*)) \rightarrow \text{rep}(P)$$

be the functor defined by $V \mapsto (V_*, V_i)_{i \in P}$ where $V_* := e_* V$ and $V_i := \text{Im}(V_p)$ where p is a path in Q with $s(p) = i$ and $t(p) = *$. (Note that the choice of p does not matter, because of the commutativity relations.) It is clear how F should be defined on morphisms.

For a proof of the following result we also refer to [Si92].

Theorem 8.13. *The restriction of F to $\text{prinj}(I(P^*))$ yields an equivalence $\text{prinj}(I(P^*))/\text{proj}(I(P)) \rightarrow \text{rep}(P)$.*

It seems that the category $\text{rep}(P)$ is more important (or at least more studied) than the categories $\text{mod}(I(P))$ and $\text{mod}(I(P^*))$. But relating $\text{rep}(P)$ to these categories as described above seems to be the right approach for getting a better understanding of $\text{rep}(P)$.

Example: Let P be the poset $3 > 1 < 4 > 2$. Then $A := I(P^*) = KQ/I$ where Q is the quiver

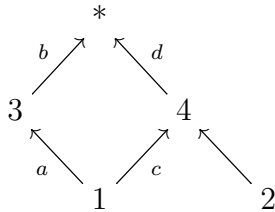

and I is generated by $ba - dc$. Here is the Auslander-Reiten quiver Γ_A (we display modules by their dimension vectors):

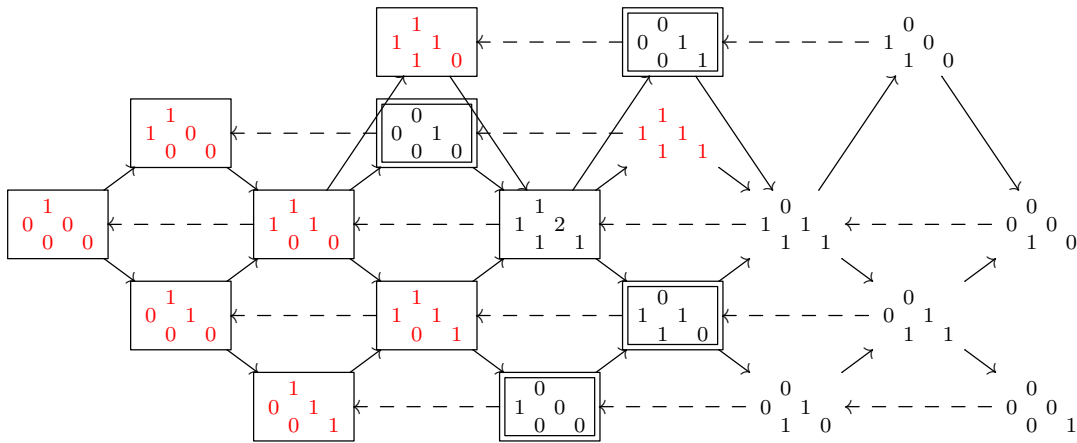

The modules in $\text{rep}(P)$ are marked in red, the modules in $\text{prinj}(A)$ are framed, and the modules in $\text{proj}(I(P))$ are double framed. The functor $F: \text{prinj}(I(P^*)) \rightarrow \text{rep}(P)$ sends the double framed modules to 0, it sends the framed red modules to themselves, and we have

$$F \begin{pmatrix} 1 & 1 & 2 \\ 1 & 1 & 1 \end{pmatrix} = \begin{pmatrix} 1 & 1 \\ 1 & 1 \end{pmatrix}.$$

The quadratic form $q_P: \mathbb{Z}^5 \rightarrow \mathbb{Z}$ associated with P is

$$q_P = \sum_{i=1}^5 x_i^2 + x_3x_1 + x_4x_1 + x_4x_2 - (x_1 + x_2 + x_3 + x_4)x_5.$$

(We identify \mathbb{Z}^{P^*} and \mathbb{Z}^5 in the obvious way.) Here are the coordinate vectors of the indecomposable modules on $\text{rep}(P)$ and $\text{prinj}(I(P^*))$:

$$\begin{array}{l}
 V \quad \begin{array}{cccccccc}
 \begin{matrix} 0 & 1 & 0 & 0 \\ 0 & 0 & 0 & 0 \end{matrix} &
 \begin{matrix} 1 & 1 & 0 & 0 \\ 1 & 0 & 0 & 0 \end{matrix} &
 \begin{matrix} 0 & 1 & 1 & 0 \\ 0 & 0 & 1 & 0 \end{matrix} &
 \begin{matrix} 1 & 1 & 1 & 0 \\ 1 & 0 & 1 & 0 \end{matrix} &
 \begin{matrix} 0 & 1 & 0 & 1 \\ 0 & 0 & 1 & 1 \end{matrix} &
 \begin{matrix} 1 & 1 & 1 & 0 \\ 1 & 1 & 1 & 0 \end{matrix} &
 \begin{matrix} 1 & 1 & 1 & 1 \\ 1 & 1 & 1 & 1 \end{matrix} \\
 \\
 \text{cdn}(V) \quad \begin{array}{cccccccc}
 \begin{matrix} 0 & 1 & 0 & 0 \\ 0 & 0 & 0 & 0 \end{matrix} &
 \begin{matrix} 1 & 1 & 0 & 0 \\ 1 & 0 & 0 & 0 \end{matrix} &
 \begin{matrix} 0 & 1 & 1 & 0 \\ 0 & 0 & 1 & 0 \end{matrix} &
 \begin{matrix} 1 & 1 & 1 & 0 \\ 1 & 0 & 1 & 0 \end{matrix} &
 \begin{matrix} 0 & 1 & 0 & 1 \\ 0 & 0 & 1 & 1 \end{matrix} &
 \begin{matrix} 0 & 1 & 0 & 0 \\ 0 & 1 & 0 & 0 \end{matrix} &
 \begin{matrix} 0 & 1 & 0 & 1 \\ 0 & 1 & 0 & 1 \end{matrix} \\
 \\
 V \quad \begin{array}{cccccc}
 \begin{matrix} 0 & 0 & 1 & 0 \\ 0 & 0 & 1 & 0 \end{matrix} &
 \begin{matrix} 1 & 0 & 0 & 0 \\ 1 & 0 & 0 & 0 \end{matrix} &
 \begin{matrix} 0 & 0 & 1 & 1 \\ 0 & 0 & 1 & 1 \end{matrix} &
 \begin{matrix} 1 & 0 & 1 & 0 \\ 1 & 1 & 1 & 0 \end{matrix} &
 \begin{matrix} 1 & 1 & 2 & 1 \\ 1 & 1 & 2 & 1 \end{matrix} \\
 \\
 \text{cdn}(V) \quad \begin{array}{cccccc}
 \begin{matrix} 0 & 0 & 1 & 0 \\ 0 & 0 & 1 & 0 \end{matrix} &
 \begin{matrix} 1 & 0 & 0 & 0 \\ 1 & 0 & 0 & 0 \end{matrix} &
 \begin{matrix} 0 & 0 & 0 & 1 \\ 0 & 0 & 0 & 1 \end{matrix} &
 \begin{matrix} 0 & 0 & 0 & 0 \\ 0 & 1 & 0 & 0 \end{matrix} &
 \begin{matrix} 0 & 1 & 0 & 1 \\ 0 & 1 & 0 & 1 \end{matrix}
 \end{array}
 \end{array}$$

8.3.3. *Varieties associated with P.* For a dimension vector d let $\text{mod}(I(P^*), d)$ be the affine variety of $I(P^*)$ -modules with dimension vector d .

Define

$$\text{mod}_{\text{sp}}(I(P^*), d) := \text{mod}(I(P^*), d) \cap \text{mod}_{\text{sp}}(I(P^*))$$

and

$$\text{prinj}(I(P^*), d) := \text{mod}(I(P^*), d) \cap \text{prinj}(I(P^*)).$$

By Proposition 8.9 we get that $\text{mod}_{\text{sp}}(I(P^*), d)$ is open in $\text{mod}(I(P^*), d)$. One can also show that $\text{prinj}(I(P^*), d)$ is open in $\text{mod}(I(P^*), d)$.

For a K -vector space V and $d \in \mathbb{N}$ let $\text{Gr}_d(V)$ be the projective variety of d -dimensional subspaces of V .

Let $d = (d_i) \in \mathbb{Z}^P$ with $d_i \leq d_j$ if $i \leq j$ in P . For a finite-dimensional K -vector space V let

$$\text{Gr}_d^P(V) := \left\{ (V_i)_i \in \prod_{i \in P} \text{Gr}_{d_i}(V) \mid V_i \subseteq V_j \text{ if } i \leq j \text{ in } P \right\}.$$

This is a projective variety whose closed points correspond to the representations $(V_*, V_i) \in \text{rep}(P)$ with $V_* = V$ and $\dim(V_i) = d_i$ for all $i \in P$.

The projective variety $\text{Gr}_d^P(V)$ is studied for example in [CFI19] and [FI19], whereas $\text{mod}_{\text{sp}}(I(P^*), d)$ and $\text{prinj}(I(P^*), d)$ are discussed in [Si92, Section 15.2].

8.3.4. *Tame and wild posets.* Let $K[T]$ be the polynomial ring in one variable T .

Assume that K be algebraically closed. The poset P is **tame** (resp. **prinjective tame**) if for each d there exist finitely many $I(P^*)$ - $K[T]$ -bimodules M_1, \dots, M_t , which are free of finite rank as right $K[T]$ -modules, such that (up to isomorphism) all but finitely many indecomposable d -dimensional socle projective (resp. prinjective) $I(P^*)$ -modules are isomorphic to a module of the form

$$M_i \otimes_{K[T]} S$$

with S a simple $K[T]$ -module.

The poset P is **wild** (resp. **prinjective wild**) if there exists a functor

$$F := M \otimes_{K\langle x, y \rangle} - : \text{mod}(K\langle x, y \rangle) \rightarrow \text{mod}_{\text{sp}}(I(P^*))$$

(resp.

$$F := M \otimes_{K\langle x, y \rangle} - : \text{mod}(K\langle x, y \rangle) \rightarrow \text{prinj}(I(P^*))$$

) where M is an $I(P^*)$ - $K\langle x, y \rangle$ -bimodule which is free of finite rank as a right $K\langle x, y \rangle$ -module such that F preserves indecomposables and reflects isomorphism classes.

Theorem 8.14 (Drozd). *Let K be algebraically closed. The following are equivalent:*

- (i) P is tame.
- (ii) P is prinjective tame.
- (iii) P is not wild.
- (iv) P is not prinjective wild.

Theorem 8.15 (Nazarova [N75]). *Let K be algebraically closed. The following are equivalent:*

- (i) P is tame.
- (ii) q_P is weakly non-negative.
- (iii) P does not contain any subposet isomorphic to one of the posets $(1, 1, 1, 1, 1)$, $(1, 1, 1, 2)$, $(2, 2, 3)$, $(1, 3, 4)$, $(1, 2, 6)$, $(N, 5)$.

8.3.5. Tame incidence algebras.

Let $A = KQ/I$ be a basic algebra. Let R be a minimal set of relations which generate I . For $i, j \in Q_0$ let $r_{ij} := |R \cap e_j KQ e_i|$. Then

$$q_A: \mathbb{Z}^{Q_0} \rightarrow \mathbb{Z}$$

$$x \mapsto \sum_{i \in Q_0} x_i^2 - \sum_{a \in Q_1} x_{s(a)} x_{t(a)} + \sum_{i, j \in Q_0} r_{ij} x_i x_j$$

is the **Tits form** of A .

The following characterization of tame incidence algebras relies on covering theory.

Theorem 8.16 (Leszczyński [L03]). *Let K be algebraically closed. For an incidence algebra $I(P)$ the following are equivalent:*

- (i) $I(P)$ is tame.
- (ii) For each convex subcategory B of the universal Galois covering $\tilde{I}(P)$ of $I(P)$, the Tits form q_B is weakly non-negative.

LITERATURE – INCIDENCE ALGEBRAS

- [CFI19] C. Cavalcante Fonseca, K. Iusenko, *On dimension of poset variety*. Linear Algebra Appl. 568 (2019), 155–164.
- [D74] Y. Drozd, *Coxeter transformations and representations of partially ordered sets*. (Russian) Funkcional. Anal. i Priložen. 8 (1974), no. 3, 34–42.
- [FI19] V. Futorny, K. Iusenko, *Stable representations of posets*. J. Pure Appl. Algebra 223 (2019), no. 12, 5251–5278.
- [IK17] M. Iovanov, G. Koffi, *On Incidence Algebras and their Representations*. arXiv:1702.03356
- [K72] M. Kleiner, *Partially ordered sets of finite type* (Russian). Investigations on the theory of representations. Zap. Nauchn. Sem. Leningrad. Otdel. Mat. Inst. Steklov. (LOMI) 28 (1972), 32–41.
- [L03] Z. Leszczyński, *Representation-tame incidence algebras of finite posets*. Colloq. Math. 96 (2003), no. 2, 293–305.
- [N75] L. Nazarova, *Partially ordered sets of infinite type*. (Russian) Izv. Akad. Nauk SSSR Ser. Mat. 39 (1975), no. 5, 963–991.
- [NR72] L. Nazarova, A. Roiter, *Representations of partially ordered sets*. Zap. Nauchn. Sem. LOMI 28 (1972), 5–31; Engl. Transl.: J. Soviet Math. 23 (1975), 585–606.
- [R11] C.M. Ringel, *Indecomposables live in all smaller lengths*. Bull. Lond. Math. Soc. 43 (2011), no. 4, 655–660.
- [Ro64] G. C. Rota, *On the foundations of combinatorial theory, I: Theory of Möbius functions*. Z. Wahrscheinlichkeitstheorie und Verw. Gebiete 2 (1964), 340–368.
(The origin of incidence algebras.)
- [Si92] D. Simson, *Linear representations of partially ordered sets and vector space categories*. Algebra, Logic and Applications, 4. Gordon and Breach Science Publishers, Montreux, 1992. xvi+499 pp.
(A beautiful book. The standard reference for the representation theory of posets.)
- [Si09] D. Simson, *Incidence coalgebras of intervally finite posets, their integral quadratic forms and comodule categories*. Colloq. Math. 115 (2009), 259–295.

Back to Overview §8 Multiplicative.

8.4. Locally hereditary algebras. Let A be a finite-dimensional K -algebra. The following definition is due to Bautista [Bau81].

A is **locally hereditary** if each non-zero homomorphism between indecomposable projective A -modules is a monomorphism.

Examples:

- (i) If A is hereditary, then A is locally hereditary.
- (ii) Each incidence algebra $I(P)$ is locally hereditary.

Proposition 8.17. *Locally hereditary algebras are triangular.*

Theorem 8.18 (Bautista [Bau81]). *If A is representation-finite and locally hereditary, then A is directed.*

LITERATURE – LOCALLY HEREDITARY ALGEBRAS

- [Bau81] R. Bautista, *On algebras close to hereditary Artin algebra*. An. Inst. Mat. Univ. Nac. Autónoma México 21 (1981), 21–104.
- [BS84] R. Bautista, D. Simson, *Torsionless modules over 1-Gorenstein l -hereditary Artinian rings*. Comm. Algebra 12 (1984), no. 7-8, 899–936.

Back to Overview §8 Multiplicative.

9. Graded algebras

§9 Graded algebras:

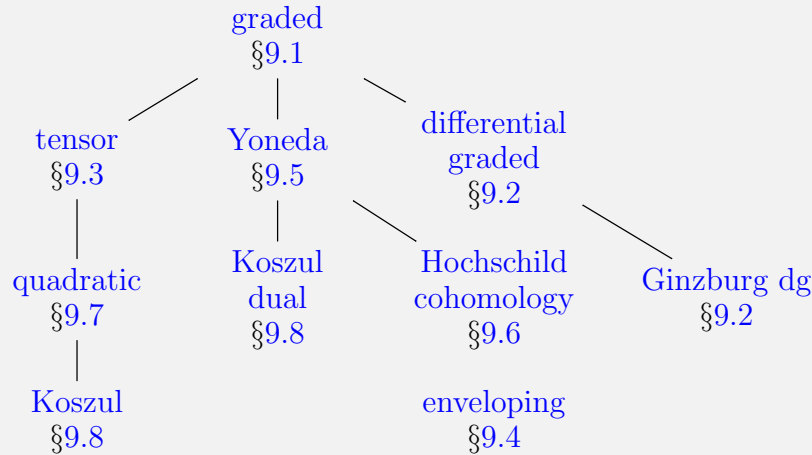

[Back to Overview Metaclasses 1.](#)

9.1. **Graded algebras.** Let A be a K -algebra, and let G be a group.

9.1.1. *Graded algebras.*

A is **G -graded** if there is a K -vector space decomposition

$$A = \bigoplus_{g \in G} A_g$$

such that

$$A_g A_h \subseteq A_{gh}$$

for all $g, h \in G$.

The direct sum above is a **G -grading** of A . The elements in A_g are **homogeneous** of degree g .

A G -grading is **full** if $\{g \in G \mid A_g \neq 0\}$ generates the group G . Without loss of generality, we always assume that G -gradings are full.

Note that $1_A \in A_{1_G}$.

A \mathbb{Z} -graded algebra A is **positively graded** (resp. **negatively graded**) provided $A_i = 0$ for all $i < 0$ (resp. $i > 0$).

Let $A = KQ/I$ be a basic algebra.

A **degree function** is a map $\deg: Q_1 \rightarrow G$. For each path $a = a_1 \cdots a_t$ of length $t \geq 1$ in Q define $\deg(a) := \deg(a_1) \cdots \deg(a_t)$. For $i \in Q_0$, set $\deg(e_i) := 1_G$.

Such a degree function \deg induces a G -grading

$$KQ = \bigoplus_{g \in G} KQ_g$$

where KQ_g is spanned by all paths a in Q with $\deg(a) = g$. Assume now that the admissible ideal I is generated by a set of homogeneous elements. We get a G -grading

$$A = \bigoplus_{g \in G} A_g$$

with $A_g := KQ_g/I := \{a + I \mid a \in KQ_g\}$. We say that A is **G -graded via \deg** .

Example: Let $A = KQ/I$ be a monomial algebra. Let $\deg: Q_1 \rightarrow G$ be any degree function. Then A is G -graded via \deg . As a special case, one can take the degree function $\deg: Q_1 \rightarrow \mathbb{Z}$ defined by $\deg(a) := 1$ for all $a \in Q_1$. Then A is \mathbb{Z} -graded via \deg .

9.1.2. Graded modules.

Assume that A is G -graded. Then $X \in \text{mod}(A)$ is **graded** if there is a K -vector space decomposition

$$X = \bigoplus_{g \in G} X_g$$

such that

$$A_g X_h \subseteq X_{gh}$$

for all $g, h \in G$.

For graded A -modules X and Y an A -module homomorphism $f: X \rightarrow Y$ is **graded** if

$$f(X_g) \subseteq Y_g$$

for all $g \in G$.

Let $\text{gr}(A)$ be the category of finite-dimensional graded A -modules with graded homomorphisms as morphisms.

There is a forgetful functor

$$F: \text{gr}(A) \rightarrow \text{mod}(A)$$

which is defined in the obvious way.

One calls $M \in \text{mod}(A)$ **gradable** if $M \cong F(X)$ for some $X \in \text{gr}(A)$.

For $h \in G$ there is a **shift functor**

$$\sigma(h): \text{gr}(A) \rightarrow \text{gr}(A)$$

defined by

$$X = \bigoplus_{g \in G} X_g \mapsto Y = \bigoplus_{g \in G} Y_g$$

where $Y_g := X_{h^{-1}g}$. It is defined in the obvious way on morphisms.

For $h \in G$, an A -module homomorphism $f: F(X) \rightarrow F(Y)$ is a **homomorphism of degree h** if

$$f(X_g) \subseteq Y_{gh}$$

for all $g \in G$.

Obviously, each A -module homomorphism $f: F(X) \rightarrow F(Y)$ is of the form

$$f = \sum_{h \in G} f_h$$

with f_h a homomorphism of degree h for each $h \in G$.

The group G is **torsion-free** if each element $g \neq 1_G$ in G has infinite order.

For example, \mathbb{Z} is torsion-free.

For the following statements, the generalization from \mathbb{Z} -graded to G -graded algebras is discussed in [G81].

Proposition 9.1 (Gordon, Green [GG82a, Section 3]). *Let A be a G -graded finite-dimensional K -algebra with G torsion-free. Then the following hold:*

- (i) $X \in \text{gr}(A)$ is indecomposable if and only if $F(X) \in \text{mod}(A)$ is indecomposable.
- (ii) Direct summands of gradable A -modules are gradable.
- (iii) Each indecomposable projective, each indecomposable injective and each simple A -module is gradable.

Proposition 9.2 ([GG82a, Section 4]). *Let A be a G -graded finite-dimensional K -algebra with G torsion-free. Let $X, Y \in \text{ind}(\text{gr}(A))$ with $F(X) \cong F(Y)$. Then there exists a unique $h \in G$ such that $X \cong \sigma(h)(Y)$ in $\text{gr}(A)$.*

Theorem 9.3 (Gordon, Green [GG82b, Section 4]). *Let A be a G -graded finite-dimensional K -algebra with G torsion-free. Then the following hold:*

- (i) *Let \mathcal{C} be a connected component of the Auslander-Reiten quiver Γ_A . If $X \in \mathcal{C}$ is gradable, then each module in \mathcal{C} is gradable.*
- (ii) *If A is representation-finite, then each $X \in \text{mod}(A)$ is gradable.*
- (iii) *If A is representation-infinite, then there are indecomposable gradable A -modules of arbitrarily large length.*

The very close connecting between coverings of quiver with relations and G -graded algebras is explained by Green [G83, Theorems 3.2 and 3.4]. The standard references for coverings are [BG81, DS85, DS857]. The following examples gives a glimpse on how this works.

Examples:

- (i) Let $A = KQ$ where Q is the Kronecker quiver

$$1 \begin{array}{c} \xleftarrow{a} \\ \xleftarrow{b} \end{array} 2$$

Let $G = \mathbb{Z}$ and set $\deg(e_1) = \deg(e_2) = \deg(a) = 0$ and $\deg(b) = 1$. Then A is G -graded via deg . Consider the infinite quiver \tilde{Q} :

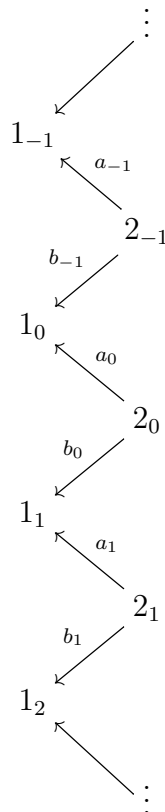

Now any finite-dimensional representation $M = (M_{1_i}, M_{2_i}, M_{a_i}, M_{b_i})$ of \tilde{Q} yields a G -graded A -module

$$M = \bigoplus_{i \in \mathbb{Z}} (M_{1_i} \oplus M_{2_i}).$$

There is an equivalence of categories

$$\text{mod}(K\tilde{Q}) \rightarrow \text{gr}(A).$$

(ii) Let $A = KQ/I$ where Q is the quiver

$$1 \xleftarrow{a} 2 \begin{array}{c} \curvearrowright \\ b \end{array}$$

and I is generated by b^2 . Let $G = \mathbb{Z}$ and set $\deg(e_1) = \deg(e_2) = \deg(a) = 0$ and $\deg(b) = 1$. Then A is G -graded via \deg . Let $\tilde{A} = K\tilde{Q}/\tilde{I}$ where \tilde{Q} is the quiver

$$\begin{array}{ccc} & & \vdots \\ & & \downarrow \\ 1_{-1} & \xleftarrow{a_{-1}} & 2_{-1} \\ & & \downarrow b_{-1} \\ 1_0 & \xleftarrow{a_0} & 2_0 \\ & & \downarrow b_0 \\ 1_1 & \xleftarrow{a_1} & 2_1 \\ & & \downarrow b_1 \\ 1_2 & \xleftarrow{a_2} & 2_2 \\ & & \downarrow \\ & & \vdots \end{array}$$

and \tilde{I} is generated by $\{b_{i+1}b_i \mid i \in \mathbb{Z}\}$. Each finite-dimensional \tilde{A} -module yields a G -graded A -module. There is an equivalence of categories

$$\text{mod}(\tilde{A}) \rightarrow \text{gr}(A).$$

In contrast to our usual convention, $K\tilde{Q}$ and \tilde{A} do not have an identity element. But the paths of length 0 provide sufficiently many idempotents to work with.

Another example can be found in Section 1.1.

LITERATURE – GRADED ALGEBRAS

[BG81] K. Bongartz, P. Gabriel, *Covering spaces in representation theory*. Invent. Math. 65 (1981/82), no. 3, 331–378.
 [DS85] P. Dowbor, A. Skowroński, *On Galois coverings of tame algebras*. Arch. Math. (Basel) 44 (1985), no. 6, 522–529.
 [DS857] P. Dowbor, A. Skowroński, *Galois coverings of representation-infinite algebras*. Comment. Math. Helv. 62 (1987), no. 2, 311–337.
 [GG82a] R. Gordon, E. Green, *Graded Artin algebras*. J. Algebra 76 (1982), no. 1, 111–137.

- [GG82b] R. Gordon, E. Green, *Representation theory of graded Artin algebras*. J. Algebra 76 (1982), no. 1, 138–152.
- [G81] E. Green, *Group-graded algebras and the zero relation problem*. Representations of algebras (Puebla, 1980), pp. 106–115, Lecture Notes in Math., 903, Springer, Berlin-New York, 1981.
- [G83] E. Green, *Graphs with relations, coverings and group-graded algebras*. Trans. Amer. Math. Soc. 279 (1983), no. 1, 297–310.

Back to Overview §9 Graded.

9.2. Differential graded algebras.

9.2.1. Differential graded algebras.

A \mathbb{Z} -graded algebra

$$A := \bigoplus_{i \in \mathbb{Z}} A_i$$

together with a cochain complex of vector spaces

$$\cdots A_{i-1} \xrightarrow{d} A_i \xrightarrow{d} A_{i+1} \xrightarrow{d} \cdots$$

with

$$d(ab) = d(a)b + (-1)^i ad(b)$$

for all $i \in \mathbb{Z}$, $a \in A_i$ and $b \in A$ is called a **differential graded algebra** (or **dg algebra** for short). We say that d is a **differential** for A .

Note that $d(1_A) = 0$.

Each algebra A can be seen as a dg algebra concentrated in degree 0, i.e. $A = A^0$ and $d = 0$.

Examples: Let $A = KQ/I$ be a gentle algebra. In particular, I is generated by a set of paths of length 2. Any degree function $\deg: Q_1 \rightarrow \mathbb{Z}$ together with the zero differential turns A into a differential graded algebra. These algebras feature prominently in work of Lekili and Polishchuk [LP20].

Let A be a dg algebra, and let $\mathcal{D}(A)$ be the **derived category** of dg A -modules. Let $\mathcal{D}^b(A)$ be its subcategory of dg A -modules whose homology is of finite total dimension, and let $\text{per}(A)$ be the subcategory of **perfect dg A -modules**. This is the smallest triangulated subcategory of $\mathcal{D}(A)$ which is closed under direct summands and which contains A . If A is homologically smooth, then $\mathcal{D}^b(A)$ is a subcategory of $\text{per}(A)$ and one can consider the triangulated quotient category $\mathcal{C}(A) := \text{per}(A)/\mathcal{D}^b(A)$. Let $\pi: \text{per}(A) \rightarrow \mathcal{C}(A)$ the canonical projection functor.

Theorem 9.4 (Amiot [A09]). *Let A be a dg algebra such that the following hold:*

- (i) A is homologically smooth,
- (ii) A is bimodule 3-Calabi-Yau,
- (iii) $H^i(A) = 0$ for all $i > 0$,
- (iv) $H^0(A)$ is finite-dimensional.

Then $\mathcal{C}(A)$ is Hom-finite and 2-Calabi-Yau. Furthermore, $\pi(A) \in \mathcal{C}(A)$ is a cluster-tilting object whose endomorphism ring is isomorphic to $H^0(A)$.

For missing definitions we refer to [A09]. In the context of Theorem 9.4, the category $\mathcal{C}(A)$ is often called the **Amiot cluster category**. These categories feature in the categorification of Fomin-Zelevinsky cluster algebras.

Meanwhile Theorem 9.4 has been generalized in various directions.

9.2.2. *Ginzburg dg algebras.* Let Q be a quiver. A **potential S for Q** is an element in KQ which is a linear combination of cycles of length at least 1 in Q .

For a cycle $a_1 \cdots a_m$ of length $m \geq 1$ in Q and an arrow $a \in Q_1$ define

$$\partial_a(a_1 \cdots a_m) := \sum_{\substack{1 \leq p \leq m \\ a_p = a}} a_{p+1} \cdots a_m a_1 \cdots a_{p-1}.$$

We extend this linearly and obtain the **cyclic derivative $\partial_a(S)$** of a potential S for Q .

Let \tilde{Q} be the quiver which is obtained from Q as follows: For each arrow $a: i \rightarrow j$ of Q add a new arrow $a^*: j \rightarrow i$. Add a new loop $t_i: i \rightarrow i$ for each vertex i of Q . Then

$$\Gamma(Q, S) := K\tilde{Q} = \bigoplus_{m \in \mathbb{Z}} \Gamma_m$$

is a \mathbb{Z} -graded algebra where

- $\deg(a) := 0$ and $\deg(a^*) := -1$ for $a \in Q_1$,
- $\deg(e_i) := 0$ and $\deg(t_i) := -2$ for $i \in Q_0$,
- Γ_m is generated by all paths of degree m .

There is a differential d

$$\cdots \xrightarrow{d} \Gamma_{-1} \xrightarrow{d} \Gamma_0 \xrightarrow{d} \Gamma_1 \xrightarrow{d} \cdots$$

defined by

- $d(a) := 0$ and $d(a^*) := \partial_a(S)$ for $a \in Q_1$,
- $d(e_i) := 0$ and $d(t_i) := e_i \left(\sum_{a \in Q_1} (aa^* - a^*a) \right) e_i$ for $i \in Q_0$.

Then $\Gamma(Q, S)$ together with d is the **Ginzburg dg algebra** associated with (Q, S) .

Ginzburg dg algebras were introduced in [G06]. They appear in different branches of mathematics, e.g. they play a crucial role in the categorification of Fomin-Zelevinsky cluster algebras and in the construction of Donaldson-Thomas invariants for certain 3-Calabi-Yau categories.

By definition, $H^i(\Gamma(Q, S)) = 0$ for all $i > 0$. Furthermore, we have

$$H^0(\Gamma(Q, S)) \cong KQ / (\partial_a(S) \mid a \in Q_1).$$

Example: Let Q be the quiver

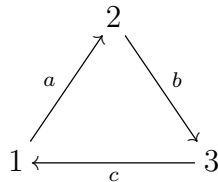

and let $S = cba$. Then \tilde{Q} is

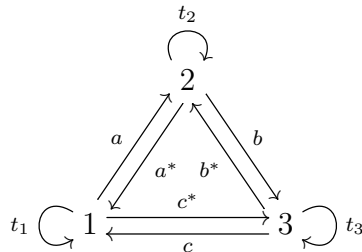

and we have $d(e_i) = d(a) = d(b) = d(c) = 0$, $d(a^*) = cb$, $d(b^*) = ac$, $d(c^*) = ba$, $d(t_1) = cc^* - a^*a$, $d(t_2) = aa^* - b^*b$, $d(t_3) = bb^* - c^*c$. We get

$$H^0(\Gamma(Q, S)) \cong KQ/(cb, ac, ba).$$

Theorem 9.5 (Keller [K11]). *The Ginzburg dg algebra $\Gamma(Q, S)$ is homologically smooth and bimodule 3-Calabi-Yau.*

Thus each Ginzburg dg algebra $\Gamma(Q, S)$ satisfies the assumptions (i), (ii) and (iii) of Theorem 9.4. For many important examples, also assumption (iv) holds.

In many situations one needs the **completed Ginzburg dg algebra** $\widehat{\Gamma}(Q, S)$ where the potential

$$S \in \widehat{KQ}$$

is now a possibly infinite linear combination of cycles of length at least 1 in Q and the underlying vector space of $\widehat{\Gamma}(Q, S)$ is

$$\widehat{KQ} = \prod_{m \in \mathbb{Z}} \Gamma_m \quad \text{instead of} \quad K\widetilde{Q} = \bigoplus_{m \in \mathbb{Z}} \Gamma_m.$$

One gets

$$H^0(\widehat{\Gamma}(Q, S)) \cong \mathcal{P}(Q, S)$$

where

$$\mathcal{P}(Q, S) := \widehat{KQ}/(\partial_a(S) \mid a \in Q_1)$$

is the Jacobian algebra associated with (Q, S) . For more details we refer to [K11, KY11].

LITERATURE – DIFFERENTIAL GRADED ALGEBRAS

- [A09] C. Amiot, *Cluster categories for algebras of global dimension 2 and quivers with potential*. Ann. Inst. Fourier (Grenoble) 59 (2009), no. 6, 2525–2590.
- [G06] V. Ginzburg, *Calabi-Yau algebras*. Preprint (2006), arXiv:math/0612139v3.
- [K11] B. Keller, *Deformed Calabi-Yau completions*. With an appendix by Michel Van den Bergh. J. Reine Angew. Math. 654 (2011), 125–180.
- [KY11] B. Keller, D. Yang, *Derived equivalences from mutations of quivers with potential*. Adv. Math. 226 (2011), no. 3, 2118–2168.
- [LP20] Y. Lekili, A. Polishchuk, *Derived equivalences of gentle algebras via Fukaya categories*. Math. Ann. 376 (2020), no. 1-2, 187–225.

Back to Overview §9 Graded.

9.3. Tensor algebras. Let A be a K -algebra, and let $M \in \text{Bimod}(A)$. For $i \geq 1$ let

$$M^{\otimes i} := M \otimes_A \cdots \otimes_A M$$

be the tensor product of i copies of M . Furthermore, let $M^{\otimes 0} := A$.

The \mathbb{Z} -graded K -algebra

$$T_A(M) := \bigoplus_{i \geq 0} M^{\otimes i}$$

is the **tensor algebra** of M .

The multiplication for $T_A(M)$ is defined by

$$(x_1 \otimes \cdots \otimes x_i)(y_1 \otimes \cdots \otimes y_j) := x_1 \otimes \cdots \otimes x_i \otimes y_1 \otimes \cdots \otimes y_j$$

for $i, j \geq 1$. For $a \in M^{\otimes 0} = A$ and $x_1 \otimes \cdots \otimes x_i \in M^{\otimes i}$ let

$$\begin{aligned} a(x_1 \otimes \cdots \otimes x_i) &:= (ax_1) \otimes x_2 \otimes \cdots \otimes x_i, \\ (x_1 \otimes \cdots \otimes x_i)a &:= x_1 \otimes \cdots \otimes x_{i-1} \otimes (x_i a). \end{aligned}$$

Example: Let Q be a quiver. Then $S := KQ_0$ is a finite-dimensional semisimple K -algebra, and $V := KQ_1$ is a finite-dimensional S - S -bimodule. We have an obvious isomorphism

$$KQ \cong T_S(V).$$

of \mathbb{Z} -graded K -algebras.

Back to Overview §9 Graded.

9.4. Enveloping algebras. Let A be a finite-dimensional K -algebra.

The algebra

$$A^e := A \otimes_K A^{\text{op}}$$

is the **enveloping algebra** of A .

The multiplication for A^e is defined by

$$(a \otimes b)(a' \otimes b') := (aa') \otimes (b \star b') = (aa') \otimes (b'b)$$

where $b \star b' := b'b$ denotes the multiplication in A^{op} .

One can identify $\text{mod}(A^e)$ with the category $\text{bimod}(A)$ of finite-dimensional A - A -bimodules.

The enveloping algebra A^e acts on A by

$$(x \otimes y)a := xay.$$

Proposition 9.6 ([SY11, Lemma 11.16]). *For each $n \geq 0$, the A^e -module $\Omega_{A^e}^n(A)$ is a projective left A -module and a projective right A -module.*

Proposition 9.7 ([SY11, Proposition 11.5]). *A is selfinjective if and only if A^e is selfinjective.*

For basic algebras A and B , Leszczyński [L94] spelled out the construction of $A \otimes_K B$ in terms of quivers with relations.

Example: Let $A = KQ/I$ where Q is the quiver

$$1 \xleftarrow{a} 2 \xleftarrow{b} 3 \xrightarrow{c} 4$$

and I is generated by $\{ab\}$. Then $A^e \cong KQ'/I'$ where Q' is the quiver

$$\begin{array}{ccccccc}
 (1, 1) & \xleftarrow{(a,1)} & (2, 1) & \xleftarrow{(b,1)} & (3, 1) & \xrightarrow{(c,1)} & (4, 1) \\
 \downarrow (1,a^{\text{op}}) & & \downarrow (2,a^{\text{op}}) & & \downarrow (3,a^{\text{op}}) & & \downarrow (4,a^{\text{op}}) \\
 (1, 2) & \xleftarrow{(a,2)} & (2, 2) & \xleftarrow{(b,2)} & (3, 2) & \xrightarrow{(c,2)} & (4, 2) \\
 \downarrow (1,b^{\text{op}}) & & \downarrow (2,b^{\text{op}}) & & \downarrow (3,b^{\text{op}}) & & \downarrow (4,b^{\text{op}}) \\
 (1, 3) & \xleftarrow{(a,3)} & (2, 3) & \xleftarrow{(b,3)} & (3, 3) & \xrightarrow{(c,3)} & (4, 3) \\
 \uparrow (1,c^{\text{op}}) & & \uparrow (2,c^{\text{op}}) & & \uparrow (3,c^{\text{op}}) & & \uparrow (4,c^{\text{op}}) \\
 (1, 4) & \xleftarrow{(a,4)} & (2, 4) & \xleftarrow{(b,4)} & (3, 4) & \xrightarrow{(c,4)} & (4, 4)
 \end{array}$$

and I' is generated by $(a, i)(b, i)$ and $(i, b^{\text{op}})(i, a^{\text{op}})$ for $1 \leq i \leq 4$ and also by all commutativity relations.

LITERATURE – ENVELOPING ALGEBRAS

- [L94] Z. Leszczyński, *On the representation type of tensor product algebras*. Fund. Math. 144 (1994), no. 2, 143–161.
- [ES08] K. Erdmann, A. Skowroński, *Periodic algebras*. Trends in representation theory of algebras and related topics, 201–251, EMS Ser. Congr. Rep., Eur. Math. Soc., Zürich, 2008.
- [SY11] A. Skowroński, K. Yamagata, *Frobenius algebras. I. Basic representation theory*. EMS Textbooks in Mathematics. European Mathematical Society (EMS), Zrich, 2011. xii+650 pp.

[Back to Overview §9 Graded.](#)

9.5. Yoneda algebras. Let A be a K -algebra.

For $M \in \text{mod}(A)$ let

$$\text{Ext}_A^\bullet(M, M) := \bigoplus_{n \geq 0} \text{Ext}_A^n(M, M)$$

be the **Yoneda algebra** of M .

The multiplication for $\text{Ext}_A^\bullet(M, M)$ comes from the Yoneda product of exact sequences

$$0 \rightarrow M \rightarrow M_1 \rightarrow \cdots \rightarrow M_n \rightarrow M \rightarrow 0.$$

Yoneda algebras are positively graded algebras.

Back to Overview §9 Graded.

9.6. Hochschild cohomology algebras. Let A be a finite-dimensional K -algebra.

The **Hochschild cohomology algebra** of A is

$$HH^\bullet(A) := \text{Ext}_{A^e}^\bullet(A, A) := \bigoplus_{i \geq 0} \text{Ext}_{A^e}^i(A, A).$$

Here $A^e := A \otimes_K A^{\text{op}}$ is the enveloping algebra of A .

Hochschild cohomology algebras are positively graded algebras.

If $\text{gl. dim}(A) < \infty$, then $\dim HH^\bullet(A) < \infty$.

We have

$$HH^0(A) \cong Z(A) \quad \text{and} \quad HH^1(A) \cong \text{Der}_K(A, A) / \text{Der}_K^0(A, A).$$

Here $Z(A)$ is the center of A ,

$$\text{Der}_K(A, A) := \{f \in \text{Hom}_K(A, A) \mid f(ab) = af(b) + f(a)b \text{ for all } a, b \in A\}$$

is the K -vector space of **derivations** of A , and

$$\text{Der}_K^0(A, A) := \{f_x \in \text{Hom}_K(A, A) \mid x \in A \text{ and } f_x(a) = ax - xa \text{ for all } a \in A\}$$

is the K -vector space of **inner derivations** of A .

The **Hochschild cohomology groups** $HH^i(A)$ control the deformations of the algebra A , see [GP95, G64].

Some explicit computations of Hochschild cohomology groups can for example be found in [RR14].

Theorem 9.8 (Happel [H89], Rickard [R91]). *Let A and B be finite-dimensional K -algebras. If there is a triangle equivalence*

$$D^b(\text{mod}(A)) \simeq D^b(\text{mod}(B)),$$

then there is an isomorphism

$$HH^\bullet(A) \cong HH^\bullet(B)$$

of \mathbb{Z} -graded algebras.

LITERATURE – HOCHSCHILD COHOMOLOGY ALGEBRAS

- [GP95] C. Geiß, J.A. de la Peña, *On the deformation theory of finite-dimensional algebras*. Manuscripta Math. 88 (1995), no. 2, 191–208.
- [G64] M. Gerstenhaber, *On the deformation of rings and algebras*. Ann. of Math. (2) 79 (1964), 59–103.
- [GSS03] E. Green, N. Snashall, O. Solberg, *The Hochschild cohomology ring of a selfinjective algebra of finite type*. Proc. Amer. Math. Soc. 131 (2003), 3387–3393.
- [H89] D. Happel, *Hochschild cohomology of finite-dimensional algebras*. Séminaire d'Algèbre Paul Dubreil et Marie-Paul Malliavin, 39ème Année (Paris, 1987/1988), 108–126, Lecture Notes in Math., 1404, Springer, Berlin, 1989.
- [RR14] M. Redondo, L. Román, *Hochschild cohomology of triangular string algebras and its ring structure*. J. Pure Appl. Algebra 218 (2014), no. 5, 925–936.
- [R91] J. Rickard, *Derived equivalences as derived functors*. J. London Math. Soc. (2) 43 (1991), no. 1, 37–48.
- [S06] A. Skowroński, *Periodicity in representation theory of algebras*. Lecture notes (2006).

[Back to Overview §9 Graded.](#)

9.7. Quadratic algebras.

A K -algebra A is a **quadratic algebra** if

$$A \cong T_S(V)/I$$

where

- (i) S is a semisimple K -algebra.
- (ii) $V \in \text{Bimod}(S)$.
- (iii) I is generated by a subset of $V \otimes_S V$.

Quadratic algebras are \mathbb{Z} -graded.

Proposition 9.9. *For a basic algebra $A = KQ/I$ the following are equivalent:*

- (i) A is quadratic.
- (ii) I is generated by a subset of KQ_2 .

LITERATURE – QUADRATIC ALGEBRAS

- [MV20] Y. Manin, B. Vallette, *Monoidal structures on the categories of quadratic data*. Doc. Math. 25 (2020), 1727–1786.
- [PP05] A. Polishchuk, L. Positselski, *Quadratic algebras*. University Lecture Series, 37. American Mathematical Society, Providence, RI, 2005. xii+159 pp.

Back to Overview §9 Graded.

9.8. **Koszul algebras.** Let

$$A = \bigoplus_{i \in \mathbb{Z}} A_i$$

be a positively graded K -algebra. (Thus $A_i = 0$ for all $i < 0$.)

A is a **Koszul algebra** if the following hold:

- (i) A_0 is a semisimple algebra.
- (ii) A_0 has a graded projective resolution

$$\cdots \xrightarrow{f_3} P_2 \xrightarrow{f_2} P_1 \xrightarrow{f_1} P_0 \xrightarrow{f_0} A_0 \rightarrow 0$$

such that P_j is generated by its degree j component for all $j \geq 0$. (All f_j are graded homomorphisms.)

Proposition 9.10 ([BGS96, Proposition 2.2.1]). *If A is a Koszul algebra, then A^{op} is also a Koszul algebra.*

Proposition 9.11 ([BGS96, Corollary 2.3.3]). *Koszul algebras are quadratic.*

Examples: Let $A = KQ/I$ where Q is the quiver

$$1 \begin{array}{c} \xrightarrow{a} \\ \xleftarrow{b} \end{array} 2 \begin{array}{c} \xrightarrow{c} \\ \xleftarrow{d} \end{array} 3$$

and I is generated by $\{ab - dc, ba, cd\}$. Thus A is the preprojective algebra of Dynkin type A_3 . The algebra A is \mathbb{Z} -graded. (The paths of length 0 have degree 0 and the arrows have degree 1.) We have $A_0 \cong A/J(A)$. There is a graded projective resolution

$$\cdots \rightarrow P_3 \rightarrow P_2 \rightarrow P_1 \rightarrow P_0 \rightarrow A_0 \rightarrow 0.$$

However P_3 is not generated in degree 3, and all graded projective resolutions of A_0 have this flaw. So A is quadratic but not Koszul. For a detailed discussion we refer to [BBK02]. (I thank Gustavo Jasso for pointing out this reference.)

The **Yoneda algebra** of A is

$$E(A) := \text{Ext}_A^\bullet(A_0, A_0) = \bigoplus_{n \geq 0} \text{Ext}_A^n(A_0, A_0)$$

where the product comes from the Yoneda product of exact sequences.

If A is a Koszul algebra, then $E(A)$ is the **Koszul dual** of A .

A Koszul algebra A is **left finite** if A_i is finitely generated as an A_0 -module for all $i \geq 0$.

Theorem 9.12 ([BGS96, Theorem 1.2.5]). *Assume that A is a left finite Koszul algebra. Then $E(A)$ is a left finite Koszul algebra, and we have*

$$E(E(A)) \cong A.$$

Examples: The following are Koszul algebras:

- (i) Finite-dimensional hereditary algebras.
- (ii) Finite-dimensional quadratic algebras A with $\text{gl. dim}(A) = 2$, see e.g. [GM96].
- (iii) Quadratic monomial algebras, see [GZ94]).

Many algebras arising from the representation theory of Lie algebras are Koszul algebras. One standard reference for this is [BGS96], see also [MOS09].

LITERATURE – KOSZUL ALGEBRAS

- [BGS96] A. Beilinson, V. Ginzburg, W. Soergel, *Koszul duality patterns in representation theory*. J. Amer. Math. Soc. 9 (1996), no. 2, 473–527.
- [BBK02] S. Brenner, M. Butler, A. King, *Periodic algebras which are almost Koszul*. Algebr. Represent. Theory 5 (2002), no. 4, 331–367.
- [GI20] J. Grant, O. Iyama, *Higher preprojective algebras, Koszul algebras, and superpotentials*. Compos. Math. 156 (2020), no. 12, 2588–2627.
- [G97] E. Green, *Introduction to Koszul algebras*. Representation theory and algebraic geometry (Waltham, MA, 1995), 45–62, London Math. Soc. Lecture Note Ser., 238, Cambridge Univ. Press, Cambridge, 1997.
- [GM96] E. Green, R. Martínez-Villa, *Koszul and Yoneda algebras*. Representation theory of algebras (Cocoyoc, 1994), 247–297, CMS Conf. Proc., 18, Amer. Math. Soc., Providence, RI, 1996.
- [GZ94] E. Green, D. Zacharia, *The cohomology ring of a monomial algebra*. Manuscripta Math. 85 (1994), no. 1, 11–23.
- [MOS09] V. Mazorchuk, S. Ovsienko, C. Stroppel, *Quadratic duals, Koszul dual functors, and applications*. Trans. Amer. Math. Soc. 361 (2009), no. 3, 1129–1172.

Back to Overview §9 Graded.

10. Other algebras

§10 Other algebras:

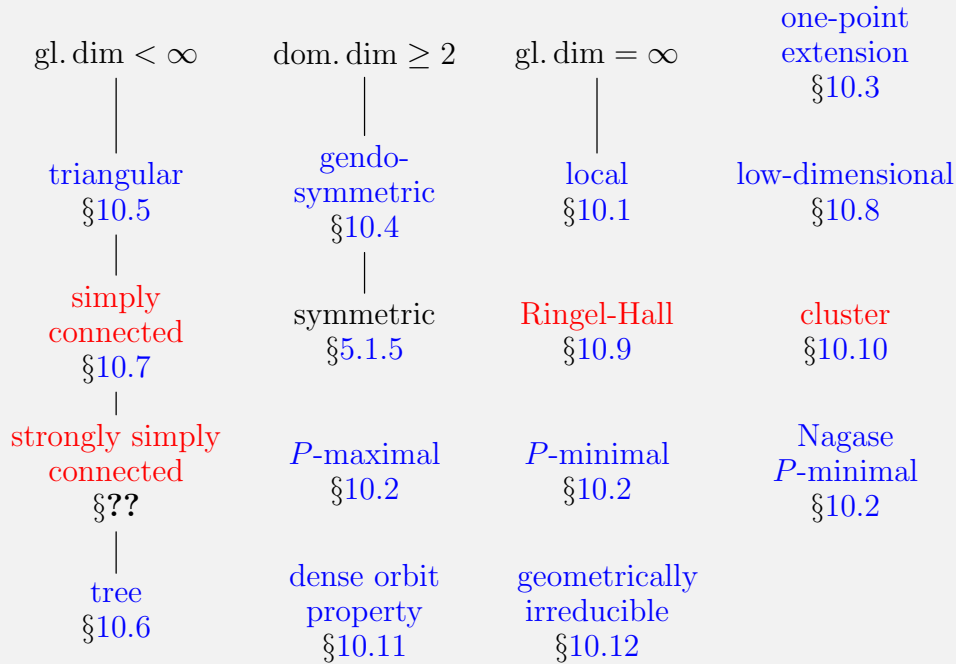

Back to Overview Metaclasses 1.

10.1. Local algebras.

A K -algebra A is **local** if ${}_A A$ has a unique maximal submodule.

It follows that A is local if and only if $A/J(A)$ is a non-zero K -skew field.

Local algebras are crucial for the understanding of direct sum decompositions of modules.

A proof of the following proposition can be found for example in [RSch20].

Proposition 10.1. *Let A be a K -algebra, and let $M \in \text{Mod}(A)$. Then the following hold:*

- (i) *If $\text{End}_A(M)$ is local, then M is indecomposable.*
- (ii) *If M is indecomposable and $\text{length}(M) < \infty$, then $\text{End}_A(M)$ is local.*

Theorem 10.2 (Krull-Remak-Schmidt-Azumaya [A50]). *Let A be a K -algebra, and let*

$$\bigoplus_{i \in I} M_i \cong \bigoplus_{j \in J} N_j$$

be an isomorphism of two direct sums of indecomposable A -modules. If $\text{End}_A(M_i)$ is local for all $i \in I$ then there exists a bijection $\sigma: I \rightarrow J$ such that

$$M_i \cong N_{\sigma(i)}$$

for all $i \in I$.

For finite sets I and J this is called the **Krull-Remak-Schmidt Theorem**.

The following definition is made up just for these notes.

A K -algebra A is **generalized local** if there exists only one simple A -module, up to isomorphism.

The following hold:

- (i) All local K -algebras are generalized local.
- (ii) For $n \geq 2$, the K -algebra $M_n(K)$ is generalized local but not local.
- (iii) A finite-dimensional K -algebra A is generalized local if and only if A is Morita equivalent to a local K -algebra.
- (iv) For a basic algebra $A = KQ/I$ the following are equivalent:
 - (a) A is local;
 - (b) A is generalized local;
 - (c) Q has only one vertex.
- (v) The power series algebra $A = K[[T]]$ is local and hereditary.

Proposition 10.3. *Let A be a finite-dimensional local K -algebra. Then for $M \in \text{Mod}(A)$ the following are equivalent:*

- (i) $\text{proj. dim}(M) = \infty$;
- (ii) M is non-projective.

Corollary 10.4. *For a finite-dimensional local K -algebra A we have*

$$\text{gl. dim}(A) = \begin{cases} 0 & \text{if } A \text{ is semisimple,} \\ \infty & \text{otherwise.} \end{cases}$$

A local basic algebra is representation-finite if and only if it is isomorphic to $K[T]/(T^n)$ for some $n \geq 1$.

Ringel [R74] determined the representation types (tame/wild) of all local basic algebras.

LITERATURE – LOCAL ALGEBRAS

- [A50] G. Azumaya, *Corrections and supplementaries to my paper concerning Krull-Remak-Schmidt's theorem*. Nagoya Math. J. 1 (1950), 117–124.
- [R74] C.M. Ringel, *The representation type of local algebras*. Proceedings of the International Conference on Representations of Algebras (Carleton Univ., Ottawa, Ont., 1974), Paper No. 22, 24 pp. Carleton Math. Lecture Notes, No. 9, Carleton Univ., Ottawa, Ont., 1974.
- [RSch20] C. Ringel, J. Schröer, *Representation theory of algebra I: Foundations*. Lecture notes (2020).

Back to Overview §10 Others.

10.2. **Minimal algebras.** Let A be a finite-dimensional K -algebra.

10.2.1. *P-Minimal algebras.*

Let P be a property satisfied by the algebra A . Then A is a **P -minimal algebra** if none of the factor algebras A/I with $I \neq 0$ satisfies P .

For example, Ringel [R11] classified the special biserial algebras which are minimal representation-infinite. He also explains how this fits into the much larger project of understanding all minimal representation-infinite algebras. As another example, Brüstle and Han [BH01] classified all minimal wild basic algebras $A = KQ/I$ such that Q has two vertices and no loops.

Warning: There are several different notions of minimality.

For example, in Section 4.3 (about concealed algebras) we consider a condition P (namely that A is representation-infinite) such that none of the factor algebras A/AeA with $e \in A$ a non-zero idempotent satisfies P . We refer also to [U90] where the same concept of minimality has been used.

Let $s(A)$ be the number of simple A -modules, up to isomorphism.

Problem 10.5 ([R02, Problem 2]). *Are there minimal wild algebras A with $s(A) > 10$?*

10.2.2. *P-maximal algebras.* Instead of *P*-minimal algebras one can also look for ***P*-maximal algebras**, in the sense that each algebra with the property *P* is isomorphic to a factor algebra of a *P*-maximal algebra.

For example, the maximal representation-finite basic algebras $A = KQ/I$ such that Q has two vertices were classified in [BG82], and the maximal tame distributive basic algebras $A = KQ/I$ such that Q has two vertices can be found in [G93].

10.2.3. *Nagase P-minimal algebras.* For a finite-dimensional K -algebra A let $s(A)$ be the number of simple A -modules, up to isomorphism.

The following interesting definition is due to Nagase and Ringel [N02, R02].

Let P be a property satisfied by the algebra A . Then A is a ***P*-Nagase minimal algebra** if the following hold:

- (i) A is *P*-minimal;
- (ii) If B is a finite-dimensional K -algebra satisfying property P , and if there exists a full, faithful and exact functor

$$\text{mod}(B) \rightarrow \text{mod}(A),$$

then $s(B) \geq s(A)$.

Example: The only Nagase minimal strictly wild basic algebra is the path algebra of the 3-Kronecker quiver

$$1 \rightrightarrows 2$$

Proposition 10.6 ([R02]). *Let A be a finite-dimensional algebra which satisfies P . Then there is a Nagase P -minimal algebra B and a full, faithful and exact functor $\text{mod}(B) \rightarrow \text{mod}(A)$.*

Problem 10.7 ([R02, Problem 3]). *Determine all Nagasa minimal wild algebras.*

LITERATURE – MINIMAL ALGEBRAS

- [BG82] K. Bongartz, P. Gabriel, *Covering spaces in representation theory*. Invent. Math. 65 (1981/82), no. 3, 331–378.
- [BH01] T. Brüstle, Y. Han, *Tame two-point algebras without loops*. Comm. Algebra 29 (2001), no. 10, 4683–4692.
- [G93] C. Geiß, *Tame distributive 2-point algebras*. Representations of algebras (Ottawa, ON, 1992), 193–204, CMS Conf. Proc., 14, Amer. Math. Soc., Providence, RI, 1993.
- [N02] H. Nagase, *τ -wild algebras*. In: Representations of algebra. Vol. I, II, 365–372, Beijing Norm. Univ. Press, Beijing, 2002.

- [R02] C.M. Ringel, *Combinatorial representation theory history and future*. In: Representations of algebra. Vol. I, II, 122–144, Beijing Norm. Univ. Press, Beijing, 2002.
- [R11] C.M. Ringel, *The minimal representation-infinite algebras which are special biserial*, Representations of algebras and related topics, 501–560, EMS Ser. Congr. Rep., Eur. Math. Soc., Zürich, 2011.
- [U90] L. Unger, *The concealed algebras of the minimal wild hereditary algebras*. Bayreuther Math. Schriften 31 (1990), 145–154.

Back to Overview §10 Others.

10.3. One-point extension algebras.

10.3.1. *One-point extensions*. Let A be a finite-dimensional K -algebra.

For $M \in \text{mod}(A)$ let

$$\mathbf{A}[M] := \begin{pmatrix} A & M \\ 0 & K \end{pmatrix}$$

be the **one-point extension** of A by M . This is a finite-dimensional K -algebra whose multiplication is defined by

$$\begin{pmatrix} a & m \\ 0 & \lambda \end{pmatrix} \begin{pmatrix} a' & m' \\ 0 & \lambda' \end{pmatrix} = \begin{pmatrix} aa' & am' + m\lambda' \\ 0 & \lambda\lambda' \end{pmatrix}.$$

(Here we use that M is an A -module and that K acts centrally on the underlying K -vector space of M .)

One point extensions (and more generally branch extensions) are a useful technique for studying (and like in the case of tubular algebras for defining) certain classes of algebras.

Examples:

- (i) Let $A' = KQ'/I'$ be a basic algebra, and let $* \in Q'_0$ be a source, i.e. there is no arrow $a \in Q_1$ with $t(a) = *$. Let $M := \text{rad}(P(*))$ and $e := 1 - e_*$. Then

$$A' \cong \begin{pmatrix} A & M \\ 0 & K \end{pmatrix}$$

with $A := eAe$.

- (ii) Let $A = KQ/I$ be a basic algebra, and let $M \in \text{mod}(A)$. We have

$$\text{top}(M) \cong \bigoplus_{i \in Q_0} S(i)^{m_i}$$

for some $m_i \geq 0$. Let Q' be the quiver obtained from Q by adding a new vertex $*$ and by adding m_i arrows $* \rightarrow i$ for each $i \in Q_0$. Then there is an

admissible ideal I' in KQ' with $I \subseteq I'$ and

$$KQ'/I' \cong \begin{pmatrix} A & M \\ 0 & K \end{pmatrix}.$$

10.3.2. *Branch extensions.*

The **full branch** $B_d = KQ_d/I_d$ of depth d is given by the quiver Q_d with vertices

$$\{k_i \mid 0 \leq k \leq d, 1 \leq i \leq 2^k\}$$

and arrows

$$\{a_{k_i} : (k+1)_{2i-1} \rightarrow k_i, b_{k_i} : k_i \rightarrow (k+1)_{2i} \mid 0 \leq k \leq d-1, 1 \leq i \leq 2^k\}$$

and the ideal I_d generated by

$$\{b_{k_i} a_{k_i} \mid 0 \leq k \leq d-1, 1 \leq i \leq 2^k\}.$$

For $d = 3$, the quiver Q_d looks like this:

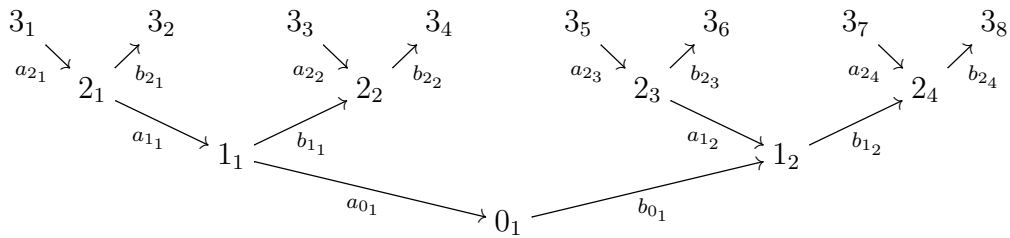

A **branch** $B = KQ/I$ is given by a full connected subquiver Q of some full branch Q_d containing the vertex 0_1 and $I := I_d \cap KQ$. Let $|B|$ be the number of vertices of B .

Let $A = KQ/I$ be a basic algebra, and let $M \in \text{mod}(A)$. Then $A[M] \cong KQ'/I'$ with $Q'_0 = Q_0 \cup \{*\}$. For a branch $B = KQ''/I''$ let

$$A[M, B] := KQ'''/I'''$$

where Q''' is obtained from Q' and Q'' by identifying the vertices $*$ and 0_1 and I''' is the ideal generated by $I' \cup I''$. The algebra $A[M, B]$ is a **branch extension** of A .

Example: Let Q be the quiver

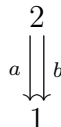

and let $A = KQ$. Let M be the representation

$$\begin{array}{c} K \\ \downarrow 1 \\ K \end{array}$$

and let $B = B_2 = KQ_2/I_2$. Then $A[M, B] \cong KQ'/I'$ where Q' is the quiver

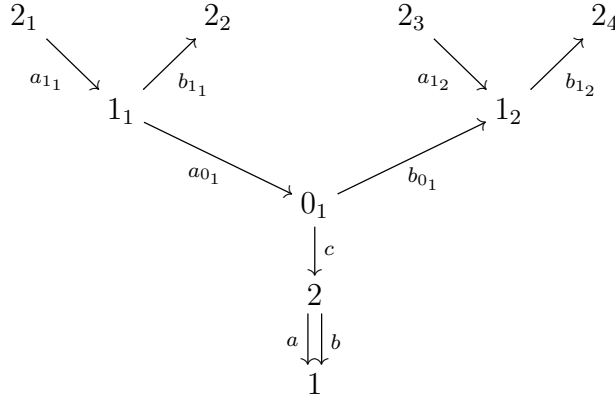

and I' is generated by $\{ac - bc, b_{11}a_{11}, b_{12}a_{12}, b_{01}a_{01}\}$.

10.3.3. *Subspace categories.* We follow [R84], [R80a, R80b] and [S92].

A **vector space category** is a pair $(\mathcal{K}, |\cdot|)$ where \mathcal{K} is a Krull-Remak-Schmidt K -category and $|\cdot|: \mathcal{K} \rightarrow \text{mod}(K)$ is a K -linear functor.

The **subspace category** $\check{U}(\mathcal{K}, |\cdot|)$ has as objects triples

$$V = (V_*, \gamma_V, V_0)$$

where $V_0 \in \mathcal{K}$, $V_* \in \text{mod}(K)$ and $\gamma_V: V_* \rightarrow |V_0|$ is a K -linear map. For objects $V, W \in \check{U}(\mathcal{K}, |\cdot|)$ a morphism

$$f = (f_*, f_0): V \rightarrow W$$

is given by $f_0 \in \text{Hom}_A(V_0, W_0)$ and $f_* \in \text{Hom}_K(V_*, W_*)$ such that $|f_0|\gamma_V = \gamma_W f_*$.

$$\begin{array}{ccc} V_* & \xrightarrow{\gamma_V} & |V_0| \\ \downarrow f_* & & \downarrow |f_0| \\ W_* & \xrightarrow{\gamma_W} & |W_0| \end{array}$$

Let $U(\mathcal{K}, |\cdot|)$ be the subcategory of $\check{U}(\mathcal{K}, |\cdot|)$ with objects $V = (V_*, \gamma_V, V_0)$ such that γ_V is a monomorphism.

- (i) The categories $\check{U}(\mathcal{K}, |\cdot|)$ and $U(\mathcal{K}, |\cdot|)$ are Krull-Remak-Schmidt K -categories.

- (ii) The only indecomposable object which is in $\check{U}(\mathcal{K}, |\cdot|)$ but not in $U(\mathcal{K}, |\cdot|)$ is $S(\omega) := (K, 0, 0)$, up to isomorphism.

A vector space category $(\mathcal{K}, |\cdot|)$ is **linear** if $|\cdot|$ is faithful and $\dim_K(|X|) = 1$ for all $X \in \text{ind}(\mathcal{K})$.

In this case, the following hold:

- (i) $\dim_K \text{Hom}_{\mathcal{K}}(X, Y) \leq 1$ for all $X, Y \in \text{ind}(\mathcal{K})$.
- (ii) If $f: X \rightarrow Y$ and $g: Y \rightarrow Z$ are non-zero morphisms with $X, Y, Z \in \text{ind}(\mathcal{K})$, then $gf: X \rightarrow Z$ is non-zero.
- (iii) The category \mathcal{K} is directed, i.e. all $X \in \text{ind}(\mathcal{K})$ are directing. (The definition of a directing object is analogous to the definition of a directing module.) It follows that the isomorphism classes of indecomposable objects in \mathcal{K} form a poset which is denoted by $P(\mathcal{K})$. (Define $[X] \leq [Y]$ if and only if $\text{Hom}_{\mathcal{K}}(X, Y) \neq 0$.)

Theorem 10.8 ([S92, Theorem 17.13(b)]). *Assume that $(\mathcal{K}, |\cdot|)$ is linear, and let $P = P(\mathcal{K})$ be the associated poset. Then there is an equivalence*

$$F_{\mathcal{K}}: \check{U}(\mathcal{K}, |\cdot|)/\mathcal{K} \rightarrow \text{rep}(P^{\text{op}}).$$

Let $V = (V_*, \gamma_V, V_0) \in \check{U}(\mathcal{K}, |\cdot|)$. We fix an isomorphism

$$V_0 \cong \bigoplus_{Y \in \text{ind}(\mathcal{K})} Y^{n_Y}$$

with $n_Y \geq 0$. Set $U := V_*$, and for $Z \in \text{ind}(\mathcal{K})$ define

$$U_Z := \text{Ker} \left(\begin{array}{ccc} V_* & \xrightarrow{\gamma_V} & |V_0| & \xrightarrow{\pi_Z} & \bigoplus_{\substack{Y \in \text{ind}(\mathcal{K}) \\ \mathcal{K}(Y, Z) \neq 0}} |Y|^{n_Y} \end{array} \right)$$

where π_Z denotes the obvious projection. Then $F_{\mathcal{K}}(V) := (U; (U_Z)_Z)$.

10.3.4. Subspace categories and one-point extensions.

Proposition 10.9. *For $M \in \text{mod}(A)$ there is an equivalence*

$$\check{U}(\text{mod}(A), \text{Hom}_A(M, -)) \rightarrow \text{mod}(A[M])$$

which sends $V = (V_, \gamma_V, V_0)$ to the $A[M]$ -module*

$$\begin{aligned} \begin{pmatrix} A & M \\ 0 & K \end{pmatrix} \times \begin{pmatrix} V_0 \\ V_* \end{pmatrix} &\rightarrow \begin{pmatrix} V_0 \\ V_* \end{pmatrix} \\ \left(\begin{pmatrix} a & m \\ 0 & \lambda \end{pmatrix}, \begin{pmatrix} v_0 \\ v_* \end{pmatrix} \right) &\mapsto \begin{pmatrix} av_0 + \bar{\gamma}_V(m \otimes v_w) \\ \lambda v_w \end{pmatrix} \end{aligned}$$

where $\bar{\gamma}_V \in \text{Hom}_A(M \otimes_K V_, V_0)$ corresponds to $\gamma_V \in \text{Hom}_K(V_*, \text{Hom}_A(M, V_0))$ under the tensor-Hom adjunction, i.e.*

$$\gamma_V: v_* \mapsto [m \mapsto \bar{\gamma}_V(m \otimes v_*)].$$

Let $A' = KQ'/I'$ be a basic algebra, and let $*$ be a source in Q . Let a_1, \dots, a_t be the arrows in Q' with $s(a_i) = *$ for $1 \leq i \leq t$. Let Q be the quiver obtained from Q' by deleting $*$. Set $A = KQ/I$ where $I := KQ \cap I'$. Let $V \in \text{mod}(A')$. We can see V as a representation $V = (V_i, V_a)_{i \in Q'_0, a \in Q'_1}$ of Q' . Set $V_0 := (V_i, V_a)_{i \in Q_0, a \in Q_1}$, and let $M := \text{rad}(P(*)) \subseteq A$. Thus $V_0, M \in \text{mod}(A)$. We get a map

$$\begin{aligned} \gamma_V: V_* &\rightarrow \text{Hom}_A(M, V_0) \\ v_* &\mapsto [m \mapsto mv_*]. \end{aligned}$$

Note that the A -module M is generated by a_1, \dots, a_t and that any $f \in \text{Hom}_A(M, V_0)$ is determined by $f(a_1), \dots, f(a_t)$. We have $\gamma_V(v_*)(a_i) = V_{a_i}(v_*)$. The functor in the previous proposition sends (V_*, γ_V, V_0) to V .

For $M \in \text{mod}(A)$ let

$$\mathcal{K}_M := \text{add}(\{X \in \text{ind}(A) \mid \text{Hom}_A(M, X) \neq 0\}).$$

The indecomposable objects in $\check{U}(\text{mod}(A), \text{Hom}_A(M, -))$ are of the form $(0, 0, V_0)$ with $V_0 \in \text{ind}(A)$ and $\text{Hom}_A(M, V_0) = 0$, or they belong to $\text{ind}(\check{U}(\mathcal{K}_M, \text{Hom}_A(M, -)))$.

Assume that $(\mathcal{K}_M, \text{Hom}_A(M, -))$ is linear, i.e. we have $\dim \text{Hom}_A(M, X) = 1$ for all $X \in \text{ind}(\mathcal{K}_M)$. Then Theorem 10.8 reduces the classification of indecomposables in $\check{U}(\mathcal{K}_M, \text{Hom}_A(M, -))$ to the classification of indecomposables in $\text{rep}(P(\mathcal{K}_M)^{\text{op}})$. In particular, the representation type of $A[M]$ depends only on the representation types of the algebra A and of the poset $P(\mathcal{K}_M)^{\text{op}}$.

Examples:

(i) Let Q be the quiver

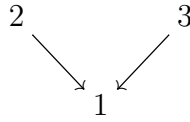

and let $A = KQ$. The AR quiver Γ_A looks as follows:

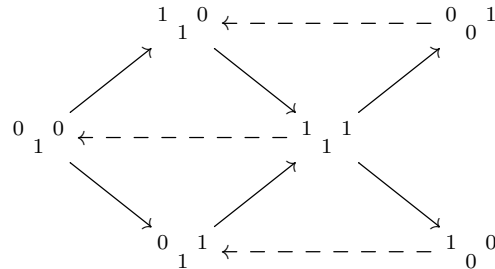

Let M, N_1, N_2 be the indecomposable A -modules with

$$\underline{\dim}(M) = \begin{matrix} 1 & 1 \\ 1 & 1 \end{matrix}, \quad \underline{\dim}(N_1) = \begin{matrix} 0 & 1 \\ 0 & 0 \end{matrix}, \quad \underline{\dim}(N_2) = \begin{matrix} 1 & 0 \\ 1 & 0 \end{matrix}.$$

It follows that $\mathcal{K}_M = \text{add}(M \oplus N_1 \oplus N_2)$, and that $(\mathcal{K}_M, |\cdot|)$ with $|\cdot| = \text{Hom}_A(M, -)$ is a linear vector space category. The poset $P := P(\mathcal{K}_M)^{\text{op}}$ is of the form

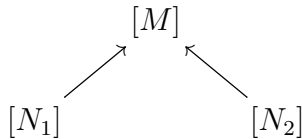

Recall that an object in $\text{rep}(P)$ consists of tuples $(U; U_M, U_{N_1}, U_{N_2})$ where U is a finite-dimensional K -vector space, and U_M, U_{N_1} and U_{N_2} are subspaces of U with $U_{N_i} \subseteq U_M$ for $i = 1, 2$. The indecomposables in $\text{rep}(P)$ are $(K; K, K, K)$, $(K; K, K, 0)$, $(K; K, 0, K)$, $(K; K, 0, 0)$, $(K; 0, 0, 0)$, up to isomorphism. Here are the irreducible morphisms in $\text{rep}(P)$:

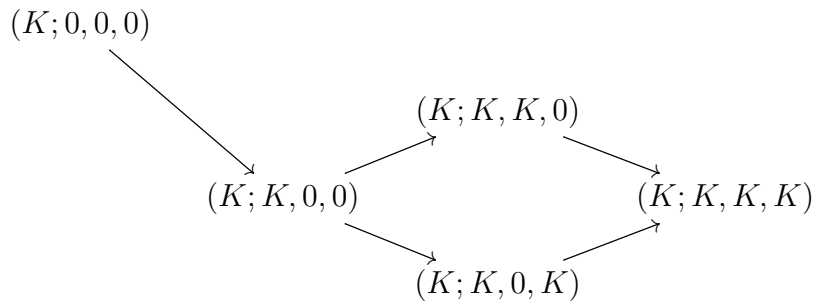

We have $A[M] \cong KQ'/I'$ where Q' is the quiver

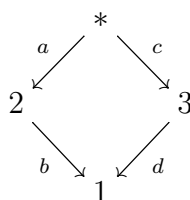

and I' is generated by $ba - dc$. The AR quiver $\Gamma_{A[M]}$ looks as follows:

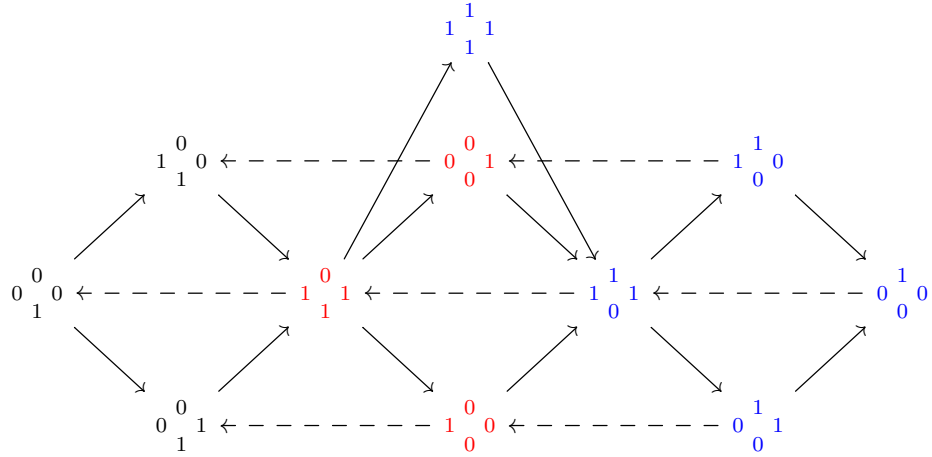

The modules marked in red and blue correspond to the indecomposables in $\check{U}(\mathcal{K}_M, |\cdot|)$, and the red ones are the indecomposables in \mathcal{K}_M . We have

$$\begin{aligned}
 F_{\mathcal{K}}\left(\begin{smallmatrix} 1 & 1 \\ 1 & 1 \end{smallmatrix}\right) &\cong (K; 0, 0, 0), & F_{\mathcal{K}}\left(\begin{smallmatrix} 1 & 1 \\ 0 & 1 \end{smallmatrix}\right) &\cong (K; K, 0, 0), \\
 F_{\mathcal{K}}\left(\begin{smallmatrix} 1 & 1 \\ 0 & 0 \end{smallmatrix}\right) &\cong (K; K, K, 0), & F_{\mathcal{K}}\left(\begin{smallmatrix} 0 & 1 \\ 0 & 1 \end{smallmatrix}\right) &\cong (K; K, 0, K), \\
 F_{\mathcal{K}}\left(\begin{smallmatrix} 0 & 1 \\ 0 & 0 \end{smallmatrix}\right) &\cong (K; K, K, K).
 \end{aligned}$$

(ii) Let $A' = KQ'/I'$ where Q' is the quiver

$$1 \begin{array}{c} \xleftarrow{a} \\ \xrightarrow{b} \end{array} 2 \xleftarrow{c} *$$

and I' is generated by $\{ac\}$. Then

$$A' \cong \begin{pmatrix} KQ & M \\ 0 & K \end{pmatrix}$$

where Q is obtained from Q' by deleting $*$, and $M \cong \text{rad}(P(*))$ is the representation

$$K \begin{array}{c} \xrightarrow{0} \\ \xrightarrow{1} \end{array} K$$

of Q . The vector space category $(\mathcal{K}_M, |\cdot|)$ with $|\cdot| = \text{Hom}_A(M, -)$ is linear. The associated poset $P := P(\mathcal{K}_M)^{\text{op}}$ is isomorphic to the total order $\mathbb{N} \cup \mathbb{N}^{\text{op}}$

where $\mathbb{N} < \mathbb{N}^{\text{op}}$. More precisely, P looks as follows:

$$\begin{array}{c}
 [N_1] \\
 \uparrow \\
 [N_2] \\
 \uparrow \\
 [N_3] \\
 \uparrow \\
 \vdots \\
 \\
 \vdots \\
 \uparrow \\
 [M_3] \\
 \uparrow \\
 [M_2] \\
 \uparrow \\
 [M_1]
 \end{array}$$

where $M_i = M((a^{-1}b)^{i-1}c)$ and $N_{i+1} = M(b(a^{-1}b)^{i-1}c)$ for $i \geq 1$ and $N_1 = M = M(b)$. (For a string C , the associated string module is denoted by $M(C)$.) It is easy to describe $\text{rep}(P)$.

LITERATURE – ONE-POINT EXTENSION ALGEBRAS

- [R80a] C.M. Ringel, *On algorithms for solving vector space problems. I. Report on the Brauer-Thrall conjectures: Rojter's theorem and the theorem of Nazarova and Rojter*. In: Representation theory, I (Proc. Workshop, Carleton Univ., Ottawa, Ont., 1979), pp. 104–136, Lecture Notes in Math., 831, Springer, Berlin, 1980.
- [R80b] C.M. Ringel, *On algorithms for solving vector space problems. II. Tame algebras*. In: Representation theory, I (Proc. Workshop, Carleton Univ., Ottawa, Ont., 1979), pp. 137–287, Lecture Notes in Math., 831, Springer, Berlin, 1980.
- [R84] C.M. Ringel, *Tame algebras and integral quadratic forms*. Lecture Notes in Mathematics, 1099. Springer-Verlag, Berlin, 1984. xiii+376 pp.
- [S92] D. Simson, *Linear representations of partially ordered sets and vector space categories*. Algebra, Logic and Applications, 4. Gordon and Breach Science Publishers, Montreux, 1992. xvi+499 pp.

Back to Overview §10 Others.

10.4. **Gendo-symmetric algebras.** Let A be a finite-dimensional algebra.

$M \in \text{mod}(A)$ is a **generator-cogenerator** of $\text{mod}(A)$ if for each $X \in \text{mod}(A)$ there exists some $n \geq 1$ together with an epimorphism $M^n \rightarrow X$ and a monomorphism $X \rightarrow M^n$.

This is the case if and only if ${}_A A \oplus D(A_A) \in \text{add}(M)$.

Let A and A' be finite-dimensional K -algebras. We write $A \sim A'$ if A and A' are Morita equivalent. For $M \in \text{mod}(A)$ and $M' \in \text{mod}(A')$ we write $(A, M) \sim (A', M')$ if there exists an equivalence $\text{mod}(A) \rightarrow \text{mod}(A')$ which restricts to an equivalence $\text{add}(M) \rightarrow \text{add}(M')$.

A proof of the following theorem can for example be found in [CB20].

Theorem 10.10 (Morita-Tachikawa correspondence). *There are mutually inverse bijections F and G between the sets*

$$\{(A, M) \mid A \text{ f.d. } K\text{-algebra, } M \text{ generator-cogenerator of } \text{mod}(A)\} / \sim$$

and

$$\{B \mid B \text{ f.d. } K\text{-algebra with } \text{dom. dim}(B) \geq 2\} / \sim$$

defined by $F: (A, M) \mapsto B$ where $B := \text{End}_A(M)^{\text{op}}$, and $G: B \mapsto (A, M)$ where $A := \text{End}_B(Q)^{\text{op}}$ and $M := \text{Hom}_B(Q, D(B_B))$ with Q an additive generator of $\text{proj-inj}(B)$.

One can now consider pairs (A, M) as above where A comes from a special class of algebras and then ask if one can say something about the algebras $B := \text{End}_A(M)^{\text{op}}$ arising in this way.

The following definition is due to Fang and König [FK16].

B is **gendo-symmetric** if

$$B \cong \text{End}_A(M)^{\text{op}}$$

where A is a finite-dimensional symmetric algebra, and M is a generator-cogenerator of $\text{mod}(A)$.

Finite-dimensional symmetric algebras A are gendo-symmetric. (The regular representation ${}_A A$ is a generator-cogenerator and $A \cong \text{End}_A({}_A A)^{\text{op}}$.)

Theorem 10.11 ([M17]). *The following are equivalent:*

- (i) A is gendo-symmetric.
- (ii) $(A, D(A_A))$ is a boc. s.

Theorem 10.12 ([KSX01]). *Let $\mathcal{C} \simeq \text{mod}(A)$ be a block of the BGG category \mathcal{O} of a complex semisimple Lie algebra. Then A is gendo-symmetric.*

The algebra A in the previous theorem is a quasi-hereditary algebra.

Theorem 10.13 ([KSX01]). *The Schur algebras $S(n, r)$ with $n \geq r$ are gendo-symmetric (and not symmetric).*

Example: Let $A = KQ/I$ where Q is the quiver

$$a \curvearrowright 1$$

and I is generated by a^2 . There are two indecomposable A -modules, namely

$$P = \begin{smallmatrix} 1 \\ | \\ 1 \end{smallmatrix} \quad \text{and} \quad S = 1.$$

The algebra A is symmetric, $M := P \oplus S$ is a generator-cogenerator of $\text{mod}(A)$ and $B := \text{End}_A(M)^{\text{op}} \cong KQ'/I'$ where Q' is the quiver

$$1 \begin{smallmatrix} \xleftarrow{a} \\ \xrightarrow{b} \end{smallmatrix} 2$$

and I is generated by ba . The algebra B is gendo-symmetric, but it is not symmetric. (We have $\text{gl. dim}(B) = 2$.)

LITERATURE – GENDO-SYMMETRIC ALGEBRAS

- [CM19] A. Chan, R. Marczinzik, *On representation-finite gendo-symmetric biserial algebras*. Algebr. Represent. Theory 22 (2019), no. 1, 141–176.
- [CB20] W. Crawley-Boevey, *Noncommutative Algebra 2: Representations of finite-dimensional algebras*. Lecture notes. Bielefeld University, Winter Semester 2019/20
- [FK16] M. Fang, S. König, *Gendo-symmetric algebras, canonical comultiplication, bar cocomplex and dominant dimension*. Trans. Amer. Math. Soc. 368 (2016), no. 7, 5037–5055.
- [KSX01] S. König, I. Slungård, C. Xi, *Double centralizer properties, dominant dimension, and tilting modules*. J. Algebra 240 (2001), no. 1, 393–412.
- [M17] R. Marczinzik, *A bocs theoretic characterization of gendo-symmetric algebras*. J. Algebra 470 (2017), 160–171.

[Back to Overview](#) §10 [Others](#).

10.5. Triangular algebras. Let A be a finite-dimensional K -algebra.

Let $S(1), \dots, S(n)$ be the simple A -modules, up to isomorphism. Then A is a **triangular algebra** if there does not exist a sequence (i_1, \dots, i_m) of indices with $m \geq 2$ and $i_1 = i_m$ such that

$$\text{Ext}_A^1(S(i_k), S(i_{k+1})) \neq 0$$

for all $1 \leq k \leq m - 1$.

Proposition 10.14. *A basic algebra $A = KQ/I$ is a triangular algebra if and only if Q has no oriented cycles.*

Proposition 10.15. *If A is a triangular algebra, then*

$$\text{gl. dim}(A) < \infty.$$

The converse of Proposition 10.15 is in general wrong.

Example: Let $A = KQ/I$ where Q is the quiver

$$1 \begin{array}{c} \xrightarrow{a} \\ \xleftarrow{b} \end{array} 2$$

and I is generated by ab . Then $\text{gl. dim}(A) \leq 2$ and A is not triangular.

There are almost no interesting results on triangular algebras in general. (One exception is mentioned below.) However, many interesting classes of finite-dimensional algebras are almost by definition triangular: Semisimple algebras, finite-dimensional path algebras, tubular algebras, canonical algebras, tree algebras, incidence algebras, and many others.

From now on assume that K is algebraically closed

Let $A = KQ/I$ be a basic algebra. Recall that a **relation** for Q is a linear combination

$$\sum_{i=1}^t \lambda_i p_i$$

of pairwise different paths p_i of length at least two in Q such that $\lambda_i \neq 0$, $s(p_i) = s(p_j)$ and $t(p_i) = t(p_j)$ for all $1 \leq i, j \leq t$. The admissible ideal I is (almost by definition) generated by a finite set of relations. Let R be a set of relations, and assume that R is of minimal cardinality such that R generates I . For $i, j \in Q_0$ define

$$r(i, j) := R \cap e_i A e_j.$$

One can show that these numbers do only depend on the isomorphism class of A and not on the choice of the admissible ideal I or the set R . For more details we refer to [?].

Let $A = KQ/I$ be a basic triangular algebra. The **Tits form** of Q is defined as

$$q_A: \mathbb{Z}^{Q_0} \rightarrow \mathbb{Z}$$

$$x \mapsto \sum_{i \in Q_0} x_i^2 - \sum_{a \in Q_1} x_{s(a)} x_{t(a)} + \sum_{i, j \in Q_0} r(i, j) x_i x_j.$$

Proposition 10.16. *Let $A = KQ/I$ be a basic triangular algebra. Assume that $\text{gl. dim}(A) \leq 2$. For $M \in \text{mod}(A)$ we have*

$$q_A(\underline{\dim}(M)) = \dim \text{End}_A(M) - \dim \text{Ext}_A^1(M, M) + \dim \text{Ext}_A^2(M, M).$$

Some of the following definitions will only be used in later sections of the FD-Atlas.

Let A be a finite-dimensional K -algebra with $\text{gl. dim}(A) < \infty$. For $M \in \text{mod}(A)$ define

$$\chi_A(M) := \sum_{i \geq 0} (-1)^i \dim \text{Ext}_A^i(M, M).$$

This value only depends on the dimension vector $\underline{\dim}(M) \in \mathbb{Z}^n$. (Here n is the number of simple A -modules, up to isomorphism.) We obtain a quadratic form

$$\chi_A: \mathbb{Z}^n \rightarrow \mathbb{Z}$$

which is called the **Euler form** of A .

Thus for a basic triangular algebra A with $\text{gl. dim}(A) \leq 2$ one can identify q_A and χ_A .

A quadratic form

$$q: \mathbb{Z}^n \rightarrow \mathbb{Z}$$

is **non-negative** (resp. **weakly non-negative**) if $q(x) \geq 0$ for all $x \in \mathbb{Z}^n$ (resp. $x \in \mathbb{N}^n$). It is **weakly positive** if $q(x) > 0$ for all $0 \neq x \in \mathbb{N}^n$.

.

A proof of the following result can be found in [?].

Theorem 10.17. *Let $A = KQ/I$ be a basic triangular algebra. If A is tame, then q_A is weakly non-negative.*

The converse is in general wrong. But it remains an interesting problem to identify classes of triangular algebra such that the converse holds.

Back to Overview §10 Others.

10.6. Tree algebras.

A basic algebra $A = KQ/I$ is a **tree algebra** if the quiver Q is a tree, i.e. Q does not contain any (oriented or non-oriented) cycles.

Tree algebras are monomial algebras.

Proposition 10.18 (Bongartz, Ringel [BR81]). *Each tree algebra has a pre-projective component.*

Corollary 10.19. *For a tree algebra A the following are equivalent:*

- (i) A is representation-finite.
- (ii) A is a directed algebra.

The representation type of a tree algebra A is characterized via its Tits form q_A . (For the definition of the Tits form q_A we refer to Section 10.5.)

Theorem 10.20 (Bongartz [B83]). *For a tree algebra A the following are equivalent:*

- (i) A is representation-finite.
- (ii) The Tits form q_A is weakly positive.

For example, all gentle tree algebras are representation-finite.

Assume from now on that K is algebraically closed.

Theorem 10.21 (Brüstle [B04]). *For a tree algebra A the following are equivalent:*

- (i) A is tame.
- (ii) The Tits form q_A is weakly non-negative.

Brüstle also shows that a tree algebra is wild if and only if it is strictly wild.

There is an algorithm which decides if q_A is weakly positive or weakly non-negative.

Example: Let $A = KQ/I$ be the tree algebra where Q is the quiver

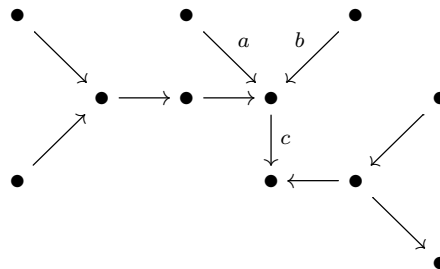

and I is generated by $\{ca, cb\}$. Then A is a tame algebra of exponential growth. (The algebra A belongs to the list of *pg-critical algebras*.)

There is also a notion of tameness for the derived category $D^b(\text{mod}(A))$ of a finite-dimensional K -algebra A . Each derived-tame algebra is tame. The converse is mostly wrong.

Theorem 10.22 (Brüstle [B01], Geiß [G02]). *For a tree algebra A the following are equivalent:*

- (i) A is derived-tame.
- (ii) The Euler form χ_A is non-negative.

(For the definition of the Euler form χ_A we refer again to Section 10.5.)

The definition of a tree algebra is straightforward, but it remains unclear if there is some homological or geometric characterization of this class of algebras.

Besides the finite/tame/wild classification of tree algebras and their derived categories, there are very few results on tree algebras in general.

LITERATURE – TREE ALGEBRAS

- [B83] K. Bongartz, *Algebras and quadratic forms*, J. London Math. Soc. (2) 28 (1983), no. 3, 461–469.
- [BR81] K. Bongartz, C.M. Ringel, *Representation-finite tree algebras*, In: Representations of algebras (Puebla, 1980), pp. 39–54, Lecture Notes in Math., 903, Springer, Berlin-New York, 1981.
- [G02] C. Geiß, *Derived tame algebras and Euler-forms*. With an appendix by the author and B. Keller. Math. Z. 239 (2002), no. 4, 829–862.
- [B01] T. Brüstle, *Derived-tame tree algebras*, Compositio Math. 129 (2001), no. 3, 301–323.
- [B04] T. Brüstle, *Tame tree algebras*, J. Reine Angew. Math. 567 (2004), 51–98.

Back to Overview §10 Others.

10.7. **Contruction site:** Simply connected algebras.

Back to Overview §10 Others.

10.8. **Low-dimensional algebras.** Let K be algebraically closed with $\text{char}(K) \neq 2$, and let A be a finite-dimensional K -algebra. This section contains the list of isomorphism classes of k -algebras of dimension at most 4. With the exception of $M_2(K)$, all of them are basic algebras KQ/I . The list is taken from Gabriel [G74]. For the list of isomorphism classes of 5-dimensional K -algebras we refer to Mazzola [M79].

1-dimensional:

(1) \bullet

2-dimensional:

(1) $\bullet \quad \bullet$

(2) $a \circlearrowleft \bullet / (a^2)$

3-dimensional:

(1) $\bullet \quad \bullet \quad \bullet$

(2) $\bullet \ a \circlearrowleft \bullet / (a^2)$

(3) $a \circlearrowleft \bullet / (a^3)$

(4) $a \circlearrowleft \bullet \circlearrowright b / (a, b)^2$

(5) $\bullet \longleftarrow \bullet$

4-dimensional:

(1) $\bullet \quad \bullet \quad \bullet \quad \bullet$

(2) $\bullet \quad \bullet \ a \circlearrowleft \bullet / (a^2)$

(3) $a \circlearrowleft \bullet \ b \circlearrowleft \bullet / (a^2, b^2)$

(4) $\bullet \ a \circlearrowleft \bullet / (a^3)$

(5) $a \circlearrowleft \bullet / (a^4)$

(6) $\bullet \ a \circlearrowleft \bullet \circlearrowright b / (a, b)^2$

(7) $a \circlearrowleft \bullet \circlearrowright b / (a^2, b^2, ab - ba)$

(8) $a \circlearrowleft \bullet \circlearrowright b / (a^3, b^2, ab, ba)$

(9) $a \circlearrowleft \bullet \circlearrowright c / (a, b, c)^2$

(10) $M_2(K)$

(11) $\bullet \xleftrightarrow[b]{a} \bullet / (ab, ba)$

(12) $a \circlearrowleft \bullet \circlearrowright b / (a^2, b^2, ab + ba)$

(13) $\bullet \quad \bullet \longleftarrow \bullet$

(14) $a \circlearrowleft \bullet \xrightarrow{b} \bullet / (a^2, ba)$

(15) $a \circlearrowleft \bullet \xleftarrow{b} \bullet / (a^2, ab)$

(16) $a \circlearrowleft \bullet \circlearrowright b / (a^2, b^2, ab)$

(17) $\bullet \xleftarrow{\quad} \bullet$

(18) $A_\lambda = a \circlearrowleft \bullet \circlearrowright b / (a^2, b^2, ab - \lambda ba)$

(19) $a \circlearrowleft \bullet \circlearrowright b / (a^2, b^2 + ab, ab + ba)$

The numbering is taken from [G74]. In (18) we have $\lambda \in K \setminus \{0, \pm 1\}$ and $A_\lambda \cong A_\mu$ if and only if $\mu \in \{\lambda, \lambda^{-1}\}$. Note that the 4-dimensional algebras (1), \dots , (9) are commutative, whereas all others are not.

Gabriel and Mazzola do much more than just computing the lists above. They consider the affine variety $\text{alg}(n)$ of n -dimensional K -algebras and determine its irreducible components (Gabriel for $n \leq 4$ and Mazzola for $n = 5$). The general linear group $\text{Gl}_n(K)$ acts on $\text{alg}(n)$ such that the orbits correspond to isomorphism classes of algebras. The closure of an orbit is a union of orbits. For $n \leq 4$ Gabriel determines all orbit closures.

LITERATURE – LOW-DIMENSIONAL ALGEBRAS

- [G74] P. Gabriel, *Finite representation type is open*. Proceedings of the International Conference on Representations of Algebras (Carleton Univ., Ottawa, Ont., 1974), Paper No. 10, 23 pp. Carleton Math. Lecture Notes, No. 9, Carleton Univ., Ottawa, Ont., 1974.
- [H79] D. Happel, *Deformations of five-dimensional algebras with unit*. Ring theory (Proc. Antwerp Conf. (NATO Adv. Study Inst.), Univ. Antwerp, Antwerp, 1978), pp. 459–494, Lecture Notes in Pure and Appl. Math., 51, Dekker, New York, 1979.
- [M79] G. Mazzola, *The algebraic and geometric classification of associative algebras of dimension five*. Manuscripta Math. 27 (1979), no. 1, 81–101.

Back to Overview §10 Others.

10.9. **Construction site:** Ringel-Hall algebras.

Back to Overview §10 Others.

10.10. **Construction site:** Cluster algebras.

Back to Overview §10 Others.

10.11. **Algebras with the dense orbit property.** Let K be algebraically closed, and let A be a finite-dimensional K -algebra. For $d \geq 0$ let $\text{mod}(A, d)$ be the affine variety of d -dimensional A -modules. The following definition is due to Chindris, Kinser and Weyman [CKW15].

A has the **dense orbit property** if for each $d \geq 0$ and $Z \in \text{Irr}(A, d)$ there is some $M \in \text{mod}(A, d)$ with

$$Z = \overline{\mathcal{O}_M}.$$

Examples:

- (i) Obviously, representation-finite algebras have the dense orbit property.

(ii) For $n \geq 2$ let $A = KQ/I$ where Q is the quiver

$$a \begin{array}{c} \circlearrowleft \\ \circlearrowright \end{array} 1 \xleftarrow{b} 2$$

and I is generated by $\{a^n, a^2b\}$. Then A has the dense orbit property, see [CKW15, Theorem 4.1]. The algebra A is wild for $n \geq 7$.

(iii) Let $A = KQ/I$ where Q is the quiver

$$a \begin{array}{c} \circlearrowleft \\ \circlearrowright \end{array} 1 \xleftarrow{b} 2 \begin{array}{c} \circlearrowleft \\ \circlearrowright \end{array} c$$

and I is generated by $\{a^n, ba - ac, c^n\}$. Then A has the dense orbit property, see [B21].

LITERATURE – ALGEBRAS WITH THE DENSE ORBIT PROPERTY

[B21] G. Bobiński, *Algebras with irreducible module varieties III: Birkhoff varieties*. Int. Math. Res. Not. IMRN 2021, no. 4, 2497–2525.

[CKW15] C. Chindris, R. Kinser, J. Weyman, *Module varieties and representation type of finite-dimensional algebras*. Int. Math. Res. Not. IMRN 2015, no. 3, 631–650.

Back to Overview §10 Others.

10.12. Geometrically irreducible algebras. Let K be algebraically closed, and let A be a finite-dimensional K -algebra. For $d \geq 0$ let $\text{mod}(A, d)$ be the affine variety of d -dimensional A -modules.

A is **geometrically irreducible** if for each $d \geq 0$ all connected components of $\text{mod}(A, d)$ are irreducible.

These algebras were introduced and studied in [BS19].

Theorem 10.23 ([BS19, Theorem 1.3]). *Assume that $\text{Ext}_A^1(S, S) = 0$ for all simple A -modules S . Then the following are equivalent:*

- (i) A is geometrically irreducible;
- (ii) A is hereditary.

By the No-Loop Theorem, if $\text{gl. dim}(A) < \infty$, then $\text{Ext}_A^1(S, S) = 0$ for all simple A -modules S .

Example: For $n \geq 2$ let $A = KQ/I$ where Q is the quiver

$$a \begin{array}{c} \circlearrowleft \\ \circlearrowright \end{array} 1 \xleftarrow{b} 2 \begin{array}{c} \circlearrowleft \\ \circlearrowright \end{array} c$$

and I is generated by $\{a^n, c^n, ab - bc\}$. It is shown in [B21] that A is geometrically irreducible.

LITERATURE – GEOMETRICALLY IRREDUCIBLE ALGEBRAS

- [B21] G. Bobiński, *Algebras with irreducible module varieties III: Birkhoff varieties*. Int. Math. Res. Not. IMRN 2021, no. 4, 2497–2525.
- [BS19] G. Bobiński, J. Schröer, *Algebras with irreducible module varieties I*. Adv. Math. 343 (2019), 624–639.

[Back to Overview](#) §10 [Others](#).

Part 2. Fundamental results, conjectures and techniques

11. Finite-dimensional algebras

In this section we want to recall some general statements about finite-dimensional K -algebras and give at least a partial answer to the question why they are special. All statements are wrong if one considers the more general class of finitely generated K -algebras.

11.1. Modules categories. Let A be a K -algebra. Let $\text{Mod}(A)$ be the category of A -modules. (By a *module* we always mean a left modules, unless stated otherwise.) Let $\text{mod}(A)$ be the category of finite-dimensional A -modules.

If A is finite-dimensional, then for $M \in \text{Mod}(A)$ the following are equivalent:

- (i) M is finite-dimensional.
- (ii) M is **finitely generated**, i.e. there exists an exact sequence

$${}_A A^n \rightarrow M \rightarrow 0$$

for some $n \geq 0$.

- (iii) M is **finitely presented**, i.e. there exists an exact sequence

$${}_A A^m \rightarrow {}_A A^n \rightarrow M \rightarrow 0$$

for some $m, n \geq 0$.

Both categories $\text{Mod}(A)$ and $\text{mod}(A)$ are abelian.

The category $\text{mod}(A)$ is a length category. In particular, it is a Krull-Remak-Schmidt category.

Our focus lies on $\text{mod}(A)$ for A finite-dimensional.

11.2. Simple modules over finite-dimensional algebras. Let A be a K -algebra. Recall that the **Jacobson radical**

$$J(A) := \text{rad}({}_A A)$$

is the intersection of all maximal left ideals in A . We proved that $J(A)$ is a two sided ideal, and that it equals the intersection of all maximal right ideals. We have also seen that an element $x \in A$ annihilates all simple A -modules if and only if $x \in J(A)$.

Let A be a finite-dimensional K -algebra. Then the following hold:

(i) We have

$$A/J(A) \cong \prod_{i=1}^n M_{n_i}(D_i)$$

with $n_i \geq 1$ and D_i a finite-dimensional K -skew field for $1 \leq i \leq n$.

(ii) Up to isomorphism, there are exactly n simple A -modules $S(1), \dots, S(n)$. We can assume that

$$S(i) = D_i^{n_i}$$

with $A/J(A)$ and A acting in the obvious way. We have

$$D_i \cong \text{End}_A(S(i))^{\text{op}}.$$

11.3. Projective and injective modules over finite-dimensional algebras.

Let A be a finite-dimensional K -algebra.

Theorem 11.1. *Up to isomorphism, there are exactly n indecomposable projective A -modules $P(1), \dots, P(n)$ and n indecomposable injective A -modules $I(1), \dots, I(n)$. We can order these such that*

$$P(i)/\text{rad}(P(i)) \cong S(i) \cong \text{soc}(I(i)).$$

We have

$${}_A A \cong \bigoplus_{i=1}^n P(i)^{n_i}$$

and

$$D(A_A) \cong \bigoplus_{i=1}^n I(i)^{n_i}$$

for some $n_i \geq 1$.

Note that in general $\dim(P(i)) \neq \dim(I(i))$.

Theorem 11.2. *Each projective A -module is a direct sum of indecomposable projectives, and each injective A -module is a direct sum of indecomposable injectives.*

Theorem 11.3. *Each $M \in \text{Mod}(A)$ has a projective cover $P(M) \rightarrow M$ and an injective envelope $M \rightarrow I(M)$.*

(Recall that injective envelopes exist for all modules over arbitrary K -algebras whereas projective covers do not exist in general.)

For $M \in \text{Mod}(A)$ the following hold:

- (i) For $P \in \text{Proj}(A)$, an epimorphism $P \rightarrow M$ is a projective cover if and only if the induced map $\text{top}(P) \rightarrow \text{top}(M)$ is an isomorphism.
- (ii) For $I \in \text{Inj}(A)$, a monomorphism $M \rightarrow I$ is an injective envelope if and only if the restriction $\text{soc}(M) \cong \text{soc}(I)$ is an isomorphism.

11.4. Homological dimensions.

11.4.1. *Projective, injective and global dimension.* For a projective resolution

$$P_\bullet = (\cdots \rightarrow P_2 \rightarrow P_1 \rightarrow P_0)$$

define

$$d(P_\bullet) := \begin{cases} \min\{m \geq 0 \mid P_{m+1} = 0\} & \text{if such an } m \text{ exists,} \\ \infty & \text{otherwise.} \end{cases}$$

For an A -module M let

$$\text{proj. dim}(M) := \min\{d(P_\bullet) \mid P_\bullet \text{ is a projective resolution of } M\}.$$

We call $\text{proj. dim}(M)$ the **projective dimension** of M .

Thus $\text{proj. dim}(M) = 0$ if and only if M is projective.

Lemma 11.4. *For $M \in \text{Mod}(A)$ and $m \geq 0$ the following are equivalent:*

- (i) $\text{proj. dim}(M) \leq m$;
- (ii) $\text{Ext}_A^{m+1}(M, -) = 0$;
- (iii) $\text{Ext}_A^{p+1}(M, -) = 0$ for all $p \geq m$.

For an injective resolution

$$I^\bullet = (I_0 \rightarrow I_1 \rightarrow I_2 \rightarrow \cdots)$$

define

$$d(I^\bullet) := \begin{cases} \min\{m \geq 0 \mid I_{m+1} = 0\} & \text{if such an } m \text{ exists,} \\ \infty & \text{otherwise.} \end{cases}$$

For an A -module M let

$$\text{inj. dim}(M) := \min\{d(I^\bullet) \mid I^\bullet \text{ is an injective resolution of } M\}.$$

We call $\text{inj. dim}(M)$ the **injective dimension** of M .

Thus $\text{inj. dim}(M) = 0$ if and only if M is injective.

Lemma 11.5. *For $N \in \text{Mod}(A)$ and $m \geq 0$ the following are equivalent:*

- (i) $\text{inj. dim}(N) \leq m$;
- (ii) $\text{Ext}_A^{m+1}(-, N) = 0$;
- (iii) $\text{Ext}_A^{p+1}(-, N) = 0$ for all $p \geq m$.

The **global dimension** of A is by definition

$$\text{gl. dim}(A) := \sup\{\text{proj. dim}(M) \mid M \in \text{Mod}(A)\}.$$

Here **sup** denotes the supremum.

Lemma 11.6. *For a K -algebra A and $m \geq 0$ the following are equivalent:*

- (i) $\text{gl. dim}(A) \leq m$;
- (ii) $\text{proj. dim}(M) \leq m$ for all $M \in \text{Mod}(A)$;
- (iv) $\text{inj. dim}(M) \leq m$ for all $M \in \text{Mod}(A)$;
- (ii) $\text{Ext}_A^{m+1}(-, ?) = 0$;
- (iii) $\text{Ext}_A^{p+1}(-, ?) = 0$ for all $p \geq m$.

Corollary 11.7. *We have*

$$\text{gl. dim}(A) = \sup\{\text{inj. dim}(M) \mid M \in \text{Mod}(A)\}.$$

As the following results show, the computation of projective, injective and global dimensions can be reduced to simple modules.

Theorem 11.8. *Let A be a finite-dimensional K -algebra. Then*

$$\text{gl. dim}(A) = \max\{\text{proj. dim}(S) \mid S \text{ is a simple } A\text{-module}\}.$$

Lemma 11.9. *Let A be a finite-dimensional K -algebra. For $M \in \text{Mod}(A)$ and $m \geq 1$ the following are equivalent:*

- (i) $\text{proj. dim}(M) \leq m$.
- (ii) $\text{Ext}_A^{m+1}(M, S) = 0$ for all simple A -modules S .

Lemma 11.10. *Let A be a finite-dimensional K -algebra. For $N \in \text{Mod}(A)$ and $m \geq 1$ the following are equivalent:*

- (i) $\text{inj. dim}(N) \leq m$.
- (ii) $\text{Ext}_A^{m+1}(S, N) = 0$ for all simple A -modules S .

Thus for a finite-dimensional K -algebra A one can determine the projective (resp. injective) dimensions of all A -modules M by computing only the injective (resp. projective) resolutions of the simple A -modules and then apply $\text{Hom}_A(M, -)$ (resp. $\text{Hom}_A(-, M)$).

11.4.2. *Dominant dimension.* Let A be a finite-dimensional K -algebra, and let

$$0 \rightarrow {}_A A \rightarrow I_0 \rightarrow I_1 \rightarrow I_2 \rightarrow \cdots$$

be a minimal injective resolution of ${}_A A$.

The following definition is due to Tachikawa [T64].

Then

$$\text{dom. dim}(A) := \begin{cases} n & \text{if } I_i \in \text{proj}(A) \text{ for } 0 \leq i \leq n-1 \text{ and } I_n \notin \text{proj}(A), \\ \infty & \text{if } I_i \in \text{proj}(A) \text{ for all } i \geq 0 \end{cases}$$

is the **dominant dimension** of A .

Remarks:

- (i) We have $\text{dom. dim}(A) = 0$ if and only if I_0 is non-projective.
- (ii) Recall that A is semisimple if and only if $\text{gl. dim}(A) = 0$. In this case, we have $\text{dom. dim}(A) = \infty$.
- (iii) More generally, it follows immediately from the definitions that for all self-injective algebras A we have $\text{dom. dim}(A) = \infty$.

Lemma 11.11. *If $\text{dom. dim}(A) < \infty$, then $\text{dom. dim}(A) \leq \text{gl. dim}(A)$.*

Lemma 11.12. *If $1 \leq \text{gl. dim}(A) < \infty$, then $\text{dom. dim}(A) \leq \text{gl. dim}(A)$.*

The following theorem indicates that the dominant dimension is an interesting invariant of an algebra.

Theorem 11.13 (Auslander Correspondence). *Up to Morita equivalence, the representation-finite algebras A correspond bijectively to the algebras B with $\text{dom. dim}(B) \geq 2 \geq \text{gl. dim}(B)$. (One takes $M \in \text{mod}(A)$ with $\text{add}(M) = \text{mod}(A)$ and maps it to $B = \text{End}_A(M)^{\text{op}}$.)*

11.4.3. *Representation dimension.* Let A be a finite-dimensional K -algebra.

$M \in \text{mod}(A)$ is a **generator-cogenerator** of $\text{mod}(A)$ provided
 $\text{proj}(A) \subseteq \text{add}(M)$ and $\text{inj}(A) \subseteq \text{add}(M)$.

The following definition is due to Auslander [A71].

Let
 $\text{rep. dim}(A) := \min\{\text{gl. dim}(\text{End}_A(M)^{\text{op}}) \mid M \text{ generator-cogenerator of } \text{mod}(A)\}$
 be the **representation dimension** of A .

Proposition 11.14. *The following are equivalent:*

- (i) $\text{rep. dim}(A) = 0$;
- (ii) A is semisimple.

Proposition 11.15. $\text{rep. dim}(A) \neq 1$.

The following theorem indicates that the representation dimension is an interesting invariant of an algebra.

Theorem 11.16 (Auslander [A71]). *The following are equivalent:*

- (i) $\text{rep. dim}(A) \leq 2$;
- (ii) A is representation-finite.

Theorem 11.17 (Rouquier [R06]). *For each $n \geq 2$ there exists an algebra A with*

$$\text{rep. dim}(A) = n.$$

Theorem 11.18 (Iyama [I03]). $\text{rep. dim}(A) < \infty$.

LITERATURE – HOMOLOGICAL DIMENSIONS

- [A71] M. Auslander, *The representation dimension of artin algebras*. Queen Mary College Mathematics Notes (1971). Republished in Selected works of Maurice Auslander. Amer. Math. Soc., Providence 1999.
- [I03] O. Iyama, *Finiteness of representation dimension*. Proc. Amer. Math. Soc. 131 (2003), no. 4, 1011–1014.
- [R06] R. Rouquier, *Representation dimension of exterior algebras*. Inventiones Math. 165 (2006), 357–367.
- [T64] H. Tachikawa, *On dominant dimension of QF-3 algebras*. Trans. Amer. Math. Soc. 112 (1964), 249–266.

11.5. Basic algebras.

A K -algebra A is **basic** provided it is finite-dimensional and

$$A/J(A) \cong \prod_{i=1}^n K.$$

Here we deviate from the usual definition which demands that

$$A/J(A) \cong \prod_{i=1}^n D_i$$

for some K -skew fields D_i .

For a K -algebra A the following are equivalent:

- (i) A is basic.
- (ii) $A \cong KQ/I$ where Q is a quiver and I is an admissible ideal in the path algebra KQ .

Let K be algebraically closed, and let A be a finite-dimensional K -algebra. Then there exists a basic K -algebra B such that $\text{mod}(A)$ and $\text{mod}(B)$ are equivalent categories.

Let A be a finite-dimensional K -algebra.

The most important A -modules are:

$$\begin{array}{lll} {}_A A \rightsquigarrow & P(1), \dots, P(n) & \text{indecomposable projective } A\text{-modules} \\ D(A_A) \rightsquigarrow & I(1), \dots, I(n) & \text{indecomposable injective } A\text{-modules} \\ A/J(A) \rightsquigarrow & S(1), \dots, S(n) & \text{simple } A\text{-modules} \end{array}$$

We can label these modules such that

$$\text{top}(P(i)) \cong S(i) \cong \text{soc}(I(i))$$

for $1 \leq i \leq n$.

Suppose that A is Morita equivalent to a basic algebra KQ/I . Then the following hold:

- (i) The vertices Q_0 correspond to the simples $S(1), \dots, S(n)$.
- (ii) The number of arrows $i \rightarrow j$ in Q_1 is $\dim \text{Ext}_A^1(S(i), S(j))$ for $1 \leq i, j \leq n$.
- (iii) Having a detailed knowledge of $P(1), \dots, P(n)$ leads to a description of I .

Remarks:

- Computing Q_1 is in general much harder than computing Q_0 .
- Computing I is in general much harder than computing Q .
- In general, I is not uniquely determined, i.e. there can be different ideals I_1 and I_2 such that $KQ/I_1 \cong KQ/I_2$.

Algebras occur in many different forms, and this determines how difficult the computation of Q and I will be.

For example, let G be a finite group, and let $A = KG$ be its group algebra with K algebraically closed. Finding the simple A -modules can be already very hard, but in many cases this is doable. If $\text{char}(K)$ does not divide $|G|$, then $Q_1 = \emptyset$ and $I = 0$. So in this case, finding the simples is enough and A is just a semisimple algebra. Otherwise, if $\text{char}(K)$ divides $|G|$, then the next challenge is to compute $\dim \text{Ext}_A^1(S(i), S(j))$.

For the symmetric groups $G = S_n$ one knows how to parametrize the simple modules. However, if $\text{char}(K)$ divides $|G|$, it seems to be close to impossible to compute $\dim \text{Ext}_A^1(S(i), S(j))$. Also the K -dimension of the simples is unknown in this case.

What is the advantage of dealing with a basic algebra $A = KQ/I$?

First, certain homological and representation theoretical information is readily available. For example, the simple modules $S(i)$ and also $\dim \text{Ext}_A^1(S(i), S(j))$ are

trivial to obtain. Also the indecomposable projective modules $P(i)$ and the indecomposable injective modules $I(i)$ can be constructed quite explicitly. An A -module is just a representation $V = (V_i, V_a)$ of Q such that the linear maps V_a satisfy the defining relations in I . So it is almost trivial to write down representations. (Classifying them up to isomorphism is another and much more complicated matter.) In case V is finite-dimensional, the Jordan-Hölder multiplicity $[V : S(i)]$ is just $\dim(V_i)$. It is also easy to compute $\text{top}(V)$ and $\text{soc}(V)$. With some effort this leads to the explicit construction of the minimal projective and the minimal injective resolution of V . (This depends a bit on the complexity of the defining relations in I .)

11.6. Algebraically closed ground fields. There are numerous publications on the representation theory of finite-dimensional K -algebras, where K is assumed to be algebraically closed. This assumption often helps, e.g. one can focus on basic algebras KQ/I . However, many results can be generalized to algebras over arbitrary ground fields without too many difficulties. One often gets the impression that the authors did not think of this issue very hard and just made a habit of always working over algebraically closed fields. In this sense, the results in the literature (including the FD-Atlas) are not always optimal.

11.7. Connected algebras. Let A be a finite-dimensional K -algebra. Then there is a unique direct sum decomposition

$$A = A_1 \oplus \cdots \oplus A_t$$

where the A_i are indecomposable two-sided ideals. (An ideal I is **indecomposable** if it cannot be written as $I = I_1 \oplus I_2$ with I_1 and I_2 non-zero two-sided ideals.) Let now $1 = e_1 + \cdots + e_t$ with $e_i \in A_i$ for $1 \leq i \leq t$. The elements e_1, \dots, e_t are a complete set of orthogonal central idempotents. Then A_i is a K -algebra with unit element e_i . We call A_1, \dots, A_t the **blocks** of A . (The terminology *block* is often just used for group algebras.)

There is an obvious K -algebra isomorphism

$$A \cong A_1 \times \cdots \times A_t.$$

Each A_i -module can be seen as an A -module in the obvious way. For each $M \in \text{Mod}(A)$ we get a direct sum decomposition

$$M = e_1M \oplus \cdots \oplus e_tM.$$

Note that $e_iM \in \text{Mod}(A_i)$ for $1 \leq i \leq t$. Thus each indecomposable A -module belongs to a unique block. The algebra A is **connected** if $t = 1$.

A basic algebra $A = KQ/I$ is connected if and only if the quiver Q is connected.

For a finite-dimensional K -algebra A the following are equivalent:

- (i) A is connected.
- (ii) If ${}_A A = U_1 \oplus U_2$ with U_1 and U_2 submodules of ${}_A A$ with $\text{Hom}_A(U_1, U_2) = \text{Hom}_A(U_2, U_1) = 0$, then $U_1 = 0$ or $U_2 = 0$.

- (iii) For any simple A -modules $S \not\cong S'$ there exists a tuple $(S_{i_1}, S_{i_2}, \dots, S_{i_t})$ of simple A -modules such that $S_{i_1} \cong S$, $S_{i_t} \cong S'$ and for each $1 \leq k \leq t-1$ we have $\text{Ext}_A^1(S_{i_k}, S_{i_{k+1}}) \oplus \text{Ext}_A^1(S_{i_{k+1}}, S_{i_k}) \neq 0$.
- (iv) 0 and 1 are the only central idempotents in A .

11.8. Various approaches to the representation theory of algebras. There are many different approaches to the representation theory of finite-dimensional algebras. Let us try to name some of them:

- (i) One can develop the representation theory of basic algebras $A = KQ/I$, i.e. try to understand $\text{mod}(A)$. Here we get certain things for free, e.g. the simple modules $S(i)$, the numbers $\dim \text{Ext}_A^1(S(i), S(j))$ and also a pretty good description of the indecomposable projectives $P(i)$ and the indecomposable injectives $I(i)$. Already the case $A = KQ$ is extremely interesting.
- (ii) There are several striking results on the representation theory of arbitrary finite-dimensional algebras without the need to use basic algebras. One can also define different classes of finite-dimensional algebras by homological conditions (e.g. hereditary algebras, quasi-hereditary algebras, tilted algebras, quasi-tilted algebras) and then study their representation theory.
- (iii) For K algebraically closed, one can take interesting K -algebras A (e.g. group algebras or certain quasi-hereditary algebras appearing in Lie Theory or diagram algebras like the Temperley-Lieb algebras) and try to find KQ/I as indicated above. To get a complete answer can be very difficult and often impossible. So this angle of representation theory only helps up to a certain degree.
- (iv) Everywhere in mathematics and physics one can look for abelian categories which are equivalent or at least somehow related to $\text{mod}(A)$ for some finite-dimensional algebra A . This can be very fruitful and often leads to new links between different research areas.
- (v) One can also take the representation theory of finite-dimensional algebras as an inspiration to develop new tools of Homological Algebra. These tools might turn out to be useful in a much wider context.
- (vi) One can look at the definitions, tools and results in other areas of mathematics and try to find analogues for finite-dimensional algebras. For example many ideas from Commutative Algebra and Algebraic Geometry turned out to be useful for finite-dimensional algebras.

12. Finite length modules

12.1. Filtrations of modules. A chain

$$0 = U_0 \subseteq U_1 \subseteq \dots \subseteq U_s = M$$

of submodules of a module M is called a **filtration** of M . The **length** of such a filtration is

$$|\{1 \leq i \leq s \mid U_i/U_{i-1} \neq 0\}|.$$

A filtration

$$0 = U'_0 \subseteq U'_1 \subseteq \cdots \subseteq U'_t = M$$

is a **refinement** of the filtration above if

$$\{U_i \mid 0 \leq i \leq s\} \subseteq \{U'_j \mid 0 \leq j \leq t\}.$$

Two filtrations

$$U_0 \subseteq U_1 \subseteq \cdots \subseteq U_s \quad \text{and} \quad V_0 \subseteq V_1 \subseteq \cdots \subseteq V_t$$

of M are called **isomorphic** if $s = t$ and there exists a bijection $\sigma: [1, s] \rightarrow [1, t]$ such that

$$U_i/U_{i-1} \cong V_{\sigma(i)}/V_{\sigma(i)-1}$$

for $1 \leq i \leq s$.

Theorem 12.1 (Schreier). *Any two filtrations of a module M have isomorphic refinements.*

12.2. Jordan-Hölder Theorem.

A filtration

$$0 = U_0 \subseteq U_1 \subseteq \cdots \subseteq U_s = M$$

of a module M is a **composition series** of M if U_i/U_{i-1} is simple for $1 \leq i \leq s$. The modules U_i/U_{i-1} are the **composition factors** of M .

For $M = 0$, we call 0 a composition series of M . It has length 0 , and there are no composition factors.

The following is a direct consequence of Theorem 12.1.

Theorem 12.2 (Jordan-Hölder). *Assume that a module M has a composition series of length s . Then the following hold:*

- (i) *Any filtration of M has length at most s and can be refined to a composition series.*
- (ii) *All composition series of M have length s and are isomorphic to each other.*

If M has a composition series of length s , then we say that M has **length** $l(M) := s$. Otherwise, M has **infinite length** and we write $l(M) = \infty$.

Let

$$0 = U_0 \subseteq U_1 \subseteq \cdots \subseteq U_s = M$$

be a composition series of M . For a simple module S let

$$[M : S] := |\{1 \leq i \leq s \mid U_i/U_{i-1} \cong S\}|$$

be the **Jordan-Hölder multiplicity** of S in M .

We know from Theorem 12.1 that the Jordan-Hölder multiplicities $[M : S]$ do not depend on the choice of a composition series of M .

One calls $([M : S])_S$ the **dimension vector** of M , where S runs through a complete set of representatives of isomorphism classes of the simple modules.

Note that only finitely many entries of the dimension vector of a finite length module M are non-zero.

For a finite-dimensional algebra A , an A -module M has finite length if and only if M is finite-dimensional.

12.3. Local endomorphism rings. The endomorphism ring $\text{End}_A(M)$ of a module M contains information about the decomposition of M into direct sums of submodules:

Proposition 12.3. *For each $M \in \text{Mod}(A)$ there is a bijection*

$$\{e \in \text{End}_A(M) \mid e^2 = e\} \rightarrow \{(U_1, U_2) \mid U_1, U_2 \text{ are submodules with } M = U_1 \oplus U_2\}.$$

defined by $e \mapsto (\text{Im}(e), \text{Ker}(e))$.

A ring R is **local** if the following hold:

- $1 \neq 0$;
- If $r \in R$, then r or $1 - r$ is invertible.

Note that we do not exclude that for some $r \in R$ both r and $1 - r$ are invertible.

Examples:

- Every skew field is a local ring.
- $M_n(K)$ is not local, provided $n \geq 2$.
- $K[T]$ is not local.
- Let $p \in K[T]$ be irreducible, and let $n \geq 1$. Then $K[T]/(p^n)$ is local.

Proposition 12.4. *Let $M \in \text{Mod}(A)$. If $\text{End}_A(M)$ is a local ring, then M is indecomposable.*

Example: The regular representation of $A = K[T]$ is indecomposable, but its endomorphism ring $\text{End}_A({}_A A) \cong K[T]^{\text{op}} \cong K[T]$ is not local. Thus the converse of the previous proposition is in general wrong.

Proposition 12.5. *Let $M \in \text{Mod}(A)$ be of finite length. Then the following are equivalent:*

- (i) V is indecomposable.
- (ii) $\text{End}_A(V)$ is a local ring.

12.4. Krull-Remak-Schmidt Theorem.

Theorem 12.6 (Krull-Remak-Schmidt). *Let M_1, \dots, M_m be A -modules with local endomorphism rings, and let N_1, \dots, N_n be indecomposable A -modules. If*

$$\bigoplus_{i=1}^m M_i \cong \bigoplus_{j=1}^n N_j$$

then $m = n$ and there exists a permutation π such that $M_i \cong N_{\pi(i)}$ for all $1 \leq i \leq m$.

As an important application, the Krull-Remak-Schmidt Theorem reduces the classification of finite length modules up to isomorphism to the classification of indecomposable finite length modules up to isomorphism.

In the literature the [Krull-Remak-Schmidt Theorem](#) is often called [Krull-Schmidt Theorem](#). But in fact, as part of his Doctoral Dissertation which he published in 1911, [Robert Remak \(1888-1942\)](#) was the first to prove such a result in the context of finite groups. Remak's PhD advisor was [Ferdinand Frobenius \(1849-1917\)](#). Afterwards Krull generalized this to modules. Schmidt did not contribute anything new, but one has to remember that there was no internet at the time and that he might have not been aware of Remak's work. When the Fascists came to power in 1933, Remak, who was of Jewish ancestry, lost his right to teach. After several weeks in the concentration camp Sachsenhausen in 1938, he managed to migrate to Amsterdam. He was later arrested by the German occupation authorities and was murdered in Auschwitz in 1942.

[Otto Schmidt \(1891-1956\)](#) was a Soviet scientist. His mother was Latvian and his father was a descendant of German settlers in Courland, hence the very German sounding name. Schmidt contributed to mathematics, geophysics, astronomy, and he was an arctic explorer. He also had an impressive political career. Amongst many other honours, Schmidt was declared a Hero of the Soviet Union, and he received the Order of Lenin three times. There is an oil on canvas painting by Jakoff Jakovlevitch Kalinitchenko from 1938 showing Stalin and Schmidt shaking hands. Given his numerous high profile positions and responsibilities, it remains Schmidt's secret how he managed to survive all the purges of the Stalin era.

After positions in Freiburg and Erlangen, [Wolfgang Krull \(1899-1971\)](#) became Professor in Bonn in 1939. His position was formerly held by [Otto Toeplitz \(1881-1940\)](#), who lost it in 1935, due to his Jewish ancestry. Toeplitz migrated in 1939 and died shortly after in Jerusalem. Krull became a member of the NS-Lehrerbund on August 1st, 1933. According to his German Wikipedia entry, a membership in the NSDAP could not be confirmed. After World War II, Krull's name was on a list of politically compromised persons, but he was readmitted to his Professor position in 1946.

13. Homological conjectures

13.1. Cartan Determinant Conjecture. Let A be a finite-dimensional K -algebra. Let $P(1), \dots, P(n)$ (resp. $I(1), \dots, I(n)$) be the indecomposable projective (resp. injective) A -modules, and let $S(1), \dots, S(n)$ be the simple A -modules, up to isomorphism. As usual, we choose the labeling such that $\text{top}(P(i)) \cong S(i) \cong \text{soc}(I(i))$.

Let C_P (resp. C_I) be the matrix with j th column the dimension vector $\underline{\dim}(P(j))$ (resp. $\underline{\dim}(I(j))$) with $1 \leq j \leq n$. The matrix $C_A := C_P$ is called the **Cartan matrix** of A .

An important aspect of the representation theory of finite-dimensional algebras is the interplay between the projective, the injective and the simple modules. The Cartan matrix helps to shed some light on this.

Let S_A be the diagonal matrix with ii -th entry $\dim \text{End}_A(S(i))$. Recall that the transpose of a matrix M is denoted by tM .

Lemma 13.1. *We have*

$${}^tC_I = S_A C_P S_A^{-1}.$$

Recall that for a basic algebra $A = KQ/I$ we have $\text{End}_A(S(i)) \cong K$ for all $1 \leq i \leq n$.

Corollary 13.2. *If $A = KQ/I$ is basic, then*

$${}^tC_I = C_P.$$

In other words, the j -th row of C_P is $\underline{\dim}(I(j))$.

Examples:

(i) For

$$A = \begin{pmatrix} \mathbb{R} & \mathbb{C} \\ 0 & \mathbb{C} \end{pmatrix}.$$

we have

$$C_A = C_P = \begin{pmatrix} 1 & 2 \\ 0 & 1 \end{pmatrix}, \quad C_I = \begin{pmatrix} 1 & 0 \\ 1 & 1 \end{pmatrix}, \quad S_A = \begin{pmatrix} 1 & 0 \\ 0 & 2 \end{pmatrix}.$$

(ii) Let $A = KQ/I$ be a basic algebra such that Q has no oriented cycles. Then $\det(C_A) = 1$.

(iii) Let $A = KQ/I$ where Q is the 1-loop quiver

$$1 \begin{array}{c} \curvearrowright \\ \curvearrowleft \end{array} a$$

and I is generated by a^m for some $m \geq 2$. Then

$$C_A = (m) \quad \text{and} \quad \det(C_A) = m.$$

Thus C_A is invertible over \mathbb{Q} , but not invertible over \mathbb{Z} .

(iv) For $m \geq 1$, let $A = KQ/I$ where Q is the quiver

$$\begin{array}{ccc} 1 & \xrightarrow{a_1} & 2 \\ & \cdots & \\ & \xrightarrow{a_m} & \\ & \searrow & \\ & & b \end{array}$$

and I is generated by all paths of length 2. Then

$$C_A = \begin{pmatrix} 1 & 1 \\ m & 1 \end{pmatrix} \quad \text{and} \quad \det(C_A) = -m + 1.$$

Theorem 13.3 (Eilenberg [E58]). *If $\text{gl. dim}(A) < \infty$, then $\det(C_A) = \pm 1$.*

In the following proposition, we treat elements in \mathbb{Z}^n as column vectors.

Proposition 13.4. *Assume that $\text{gl. dim}(A) < \infty$. For $X, Y \in \text{mod}(A)$ we have*

$$\langle X, Y \rangle_A := \sum_{i \geq 0} (-1)^i \dim \text{Ext}_A^i(X, Y) = {}^t \underline{\dim}(X) ({}^t C_A)^{-1} S_A \underline{\dim}(Y).$$

The following conjecture is still wide open. Up to our knowledge it was first spelled out by Zacharia [Z83].

Conjecture 13.5. *If $\text{gl. dim}(A) < \infty$, then $\det(C_A) = 1$.*

The Cartan Determinant Conjecture is discussed for example in [FZH86].

LITERATURE - CARTAN DETERMINANT CONJECTURE

- [E58] S. Eilenberg, *Algebras of cohomologically finite dimension*, Comment. Math. Helv. 28 (1958), 310–319.
- [FZH86] K.R. Fuller, B. Zimmermann-Huisgen, *On the generalized Nakayama conjecture and the Cartan determinant problem*, Trans. Amer. Math. Soc. 294 (1986), no. 2, 679–691.
- [Z83] D. Zacharia, *On the Cartan matrix of an Artin algebra of global dimension two*. J. Algebra 82 (1983), no. 2, 353–357.

13.2. Finitistic Dimension Conjectures. Let A be a finite-dimensional K -algebra.

Let

$$\text{fn. dim}(A) := \sup\{\text{proj. dim}(M) \mid M \in \text{mod}(A), \text{proj. dim}(M) < \infty\}$$

be the **finitistic dimension** of A .

The following famous conjecture was first formulated by Bass [Ba60].

Conjecture 13.6 (Finitistic Dimension Conjecture). $\text{fin. dim}(A) < \infty$.

Conjecture 13.6 has been confirmed for various classes of algebras. However, most classes of well understood algebras are defined by relatively easy relations like zero relations or commutativity relations. Examples with complicated overlapping relations involving scalars are hard to handle. So despite more than 100 publications on this conjecture, there is in fact not much evidence supporting it. For an overview we refer to [ZH95].

Note that

$$\text{fin. dim}(A^{\text{op}}) = \sup\{\text{inj. dim}(M) \mid M \in \text{mod}(A), \text{inj. dim}(M) < \infty\}.$$

(Here we use the duality $D: \text{mod}(A) \rightarrow \text{mod}(A^{\text{op}})$.)

Conjecture 13.7. $\text{fin. dim}(A) < \infty$ if and only if $\text{fin. dim}(A^{\text{op}}) < \infty$.

Example: We give an example due to Happel [H] of a finite-dimensional algebra A with

$$\text{fin. dim}(A) \neq \text{fin. dim}(A^{\text{op}}).$$

Let Q be the quiver

$$n \longrightarrow n-1 \longrightarrow \cdots \longrightarrow 2 \longrightarrow 1 \curvearrowright$$

and let $A = KQ/I$ where I is generated by all paths of length 2 in Q . Then

$$\text{fin. dim}(A) = 0 \quad \text{and} \quad \text{fin. dim}(A^{\text{op}}) = n-1.$$

Proposition 13.8. *The following are equivalent:*

- (i) $\text{fin. dim}(A) = 0$;
- (ii) $\text{Hom}_A(D(A_A), S) \neq 0$ for all simple A -modules S .

For example, if A is local, then $\text{fin. dim}(A) = 0$.

Let

$$\text{Fin. Dim}(A) := \sup\{\text{proj. dim}(M) \mid M \in \text{Mod}(A), \text{proj. dim}(M) < \infty\}$$

be the **big finitistic dimension** of A .

(Thus the supremum is now taken over all A -modules with finite projective dimension, and not just over all finite-dimensional A -modules with finite projective dimension.)

We obviously have

$$\text{fin.dim}(A) \leq \text{Fin.Dim}(A).$$

Zimmermann-Huisgen [ZH92, ZH95] found the first examples of finite-dimensional algebras A with

$$\text{fin.dim}(A) \neq \text{Fin.Dim}(A).$$

She studied this phenomenon in the context of monomial algebras. Smalø [S98] constructed another class of examples:

For $n \geq 1$ let $Q(n)$ be the quiver

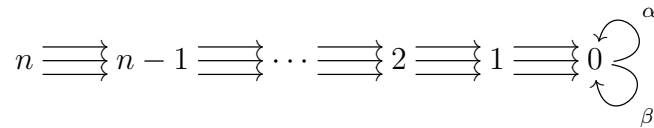

where the arrows $i \rightarrow i - 1$ are denoted by ρ_i, σ_i, τ_i for $1 \leq i \leq n$. Let

$$A(n) := KQ(n)/I(n)$$

where $I(n)$ is the ideal in $KQ(n)$ generated by the following list of relations:

- $\alpha^2, \beta^2, \alpha\beta, \beta\alpha, \alpha\rho_1, \alpha\sigma_1, \beta\tau_1,$
- $x_i y_{i+1}$ for $1 \leq i \leq n - 1$ and $x \neq y$ with $x, y \in \{\rho, \sigma, \tau\},$
- $x_i x_{i+1} - y_i y_{i+1}$ for $1 \leq i \leq n - 1$ and $x, y \in \{\rho, \sigma, \tau\}.$

The modules $P(0), P(1)$ and $P(i)$ for $2 \leq i \leq n$ look as follows:

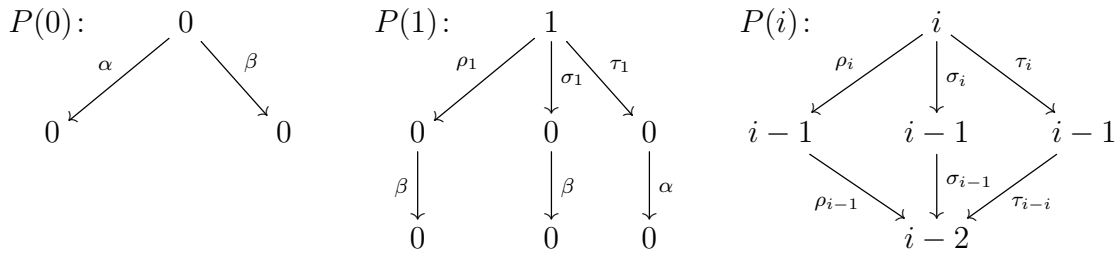

Theorem 13.9 (Smalø [S98]). For $n \geq 1$ we have

$$\text{fin.dim}(A(n)) = 1 \quad \text{and} \quad \text{Fin.Dim}(A(n)) = n.$$

When I could not understand one step of Smalø’s proof and asked him about it, I got this slightly cryptic answer:

“The idea is based on the fact that $2 < 3$, and therefore $2n < 3n$ for all natural numbers $n \geq 1$. However, $2\infty = 3\infty.$ ”

Actually, this really helped...

LITERATURE - FINITISTIC DIMENSION CONJECTURES

- [Ba60] H. Bass, *Finitistic dimension and a homological generalization of semiprimary rings*. Trans. Amer. Math. Soc. 95 (1960), 466–488.
- [H] D. Happel, *Homological conjectures in representation theory of finite-dimensional algebras*, Unpublished note.
- [S98] S. Smalø, *The supremum of the difference between the big and little finitistic dimensions is infinite*, Proc. Amer. Math. Soc. 126 (1998), no. 9, 2619–2622.
- [ZH92] B. Zimmermann-Huisgen, *Homological domino effects and the first finitistic dimension conjecture*. Invent. Math. 108 (1992), no. 2, 369–383.
- [ZH95] B. Zimmermann-Huisgen, *The finitistic dimension conjectures—a tale of 3.5 decades*, Abelian groups and modules (Padova, 1994), 501–517, Math. Appl., 343, Kluwer Acad. Publ., Dordrecht, 1995.

13.3. Nakayama Conjectures. Let A be a finite-dimensional K -algebra, and let

$$0 \rightarrow {}_A A \rightarrow I_0 \rightarrow I_1 \rightarrow \cdots$$

be a minimal injective resolution of the regular representation of A .

Conjecture 13.10 (Nakayama Conjecture [N58]). *If I_i is projective for all $i \geq 0$, then A is selfinjective.*

Here is an obvious reformulation of the Nakayama Conjecture:

Conjecture 13.11. *If $\text{dom. dim}(A) = \infty$, then A is selfinjective.*

Proposition 13.12. *If the Finitistic Dimension Conjecture is true for A , then the Nakayama Conjecture is true for A .*

Conjecture 13.13 (Generalized Nakayama Conjecture [AR75]). *For each indecomposable injective A -module I there exists some $j \geq 0$ such that I is isomorphic to a direct summand of I_j .*

Proposition 13.14. *If the Generalized Nakayama Conjecture is true for A , then the Nakayama Conjecture is true for A .*

Proposition 13.15. *The following hold:*

(i) *Let $M \in \text{mod}(A)$ be non-zero with $\text{proj. dim}(M) = n < \infty$. Then*

$$\text{Ext}_A^n(M, {}_A A) \neq 0.$$

(ii) *Suppose that $\text{gl. dim}(A) = n < \infty$. Then the following hold:*

(a) *$\text{inj. dim}({}_A A) = \text{gl. dim}(A)$.*

(b) *The Generalized Nakayama Conjecture is true for A .*

Conjecture 13.16. *Let S be a simple A -module. Then there exists some $i \geq 0$ such that*

$$\mathrm{Ext}_A^i(S, {}_A A) \neq 0.$$

Proposition 13.17. *The Generalized Nakayama Conjecture is true for A if and only if Conjecture 13.16 is true for A .*

Here is an even stronger conjecture which is discussed in [CF90] (I do not know if there is an older reference for this):

Conjecture 13.18 (Strong Nakayama Conjecture [CF90]). *Let $M \in \mathrm{mod}(A)$ be non-zero. Then there exists some $i \geq 0$ such that*

$$\mathrm{Ext}_A^i(M, {}_A A) \neq 0.$$

Proposition 13.19. *If the Finitistic Dimension Conjecture is true for A^{op} , then the Strong Nakayama Conjecture is true for A .*

LITERATURE - NAKAYAMA CONJECTURES

- [AR75] M. Auslander, I. Reiten, *On a generalized version of the Nakayama conjecture*. Proc. Amer. Math. Soc. 52 (1975), 69–74.
 [CF90] R. Colby, R. Fuller, *A note on the Nakayama conjectures*. Tsukuba J. Math. 14 (1990), no. 2, 343–352.
 [N58] T. Nakayama, *On algebras with complete homology*. Abh. Math. Sem. Univ. Hamburg 22 (1958), 300–307.

13.4. No Loop Conjectures. Let A be a finite-dimensional K -algebra.

Conjecture 13.20 (No Loop Conjecture). *Let S be a simple A -module with $\mathrm{Ext}_A^1(S, S) \neq 0$. Then $\mathrm{gl. dim}(A) = \infty$.*

Theorem 13.21 (Igusa [I90], Lenzing [L69]). *Assume that K is algebraically closed. Then Conjecture 13.20 is true.*

Conjecture 13.22 (Strong No Loop Conjecture). *Let S be a simple A -module with $\mathrm{Ext}_A^1(S, S) \neq 0$. Then $\mathrm{proj. dim}(S) = \infty$.*

Theorem 13.23 (Igusa, Liu, Paquette [ILP11]). *Assume that K is algebraically closed. Then Conjecture 13.22 is true.*

The following even stronger conjecture is due to Liu and Morin [LM04].

Conjecture 13.24 (Very Strong No Loop Conjecture). *Let S be a simple A -module with $\text{Ext}_A^1(S, S) \neq 0$. Then $\text{Ext}_A^i(S, S) \neq 0$ for infinitely many i .*

LITERATURE - NO LOOP CONJECTURES

- [I90] K. Igusa, *Notes on the no loops conjecture*. J. Pure Appl. Algebra 69 (1990), no. 2, 161–176.
 [ILP11] K. Igusa, S. Liu, C. Paquette, *A proof of the strong no loop conjecture*. Adv. Math. 228 (2011), no. 5, 2731–2742.
 [L69] H. Lenzing, *Nilpotente Elemente in Ringen von endlicher globaler Dimension*. (German) Math. Z. 108 (1969), 313–324.
 [LM04] S. Liu, J. Morin, *The strong no loop conjecture for special biserial algebras*. Proc. Amer. Math. Soc. 132 (2004), no. 12, 3513–3523.

13.5. **Global dimension conjectures.** Let A be a K -algebra.

The **global dimension** of A is

$$\text{gl. dim}(A) := \sup\{\text{proj. dim}(M) \mid M \in \text{Mod}(A)\}.$$

Here **sup** denotes the supremum.

Proposition 13.25. *For $m \geq 0$ the following are equivalent:*

- (i) $\text{gl. dim}(A) \leq m$.
- (ii) $\text{Ext}_A^{m+1}(-, ?) = 0$.

Corollary 13.26. *We have*

$$\text{gl. dim}(A) = \sup\{\text{inj. dim}(M) \mid M \in \text{Mod}(A)\}.$$

There are examples of infinite-dimensional K -algebras A such that

$$\text{gl. dim}(A) \neq \text{gl. dim}(A^{\text{op}}).$$

Recall that an A -module is **cyclic** if it can be generated by a single element.

Clearly, an A -module M is cyclic if and only if $M \cong {}_A A/U$ for some submodule U of the regular representation ${}_A A$.

Theorem 13.27 (Auslander [A55]). *We have*

$$\text{gl. dim}(A) = \sup\{\text{proj. dim}(M) \mid M \text{ is a cyclic } A\text{-module}\}.$$

Corollary 13.28. *For a finite-dimensional K -algebra A we have*

$$\text{gl. dim}(A) = \max\{\text{proj. dim}(S) \mid S \text{ is a simple } A\text{-module}\}.$$

Conjecture 13.29 (Marczinik [M18]). *For a finite-dimensional K -algebra A we have*

$$\text{gl. dim}(A) = \text{inj. dim}(J(A)).$$

Let Q be a quiver. We know that $\text{gl. dim}(KQ) \leq 1$, even if KQ is infinite-dimensional.

Proposition 13.30. *Let $A = KQ/I$ be a basic algebra with $I \neq 0$. Then*

$$\text{gl. dim}(A) \geq 2.$$

If Q has a loop and K is algebraically closed, then $\text{gl. dim}(KQ/I) = \infty$ for all admissible ideals I . (This follows from Theorem 13.21.)

Theorem 13.31 (Dlab, Ringel [DR89, DR90]). *Let Q be a quiver without loops. Then there exists an admissible ideal I such that*

$$\text{gl. dim}(KQ/I) \leq 2.$$

Proposition 13.32. *For a basic algebra $A = KQ/I$ we have*

$$\text{gl. dim}(A) \leq \sup\{\text{length}(p) \mid p \text{ is a path in } Q\}.$$

Problem 13.33. *Given a quiver Q and some $d \geq 1$. Find a sufficient and necessary condition on Q such that there exists an admissible ideal I with*

$$\text{gl. dim}(KQ/I) = d.$$

Following Happel and Zacharia [HZ13] we define

$$g(Q) := \sup\{\text{gl. dim}(KQ/I) \mid I \text{ admissible in } KQ, \text{gl. dim}(KQ/I) < \infty\}$$

and

$$d(Q) := \sup\{\dim_K(KQ/I) \mid I \text{ admissible in } KQ, \text{gl. dim}(KQ/I) < \infty\}.$$

Theorem 13.34 (Schofield [S85]). *Let K be algebraically closed. There is a function $f: \mathbb{N} \rightarrow \mathbb{N}$ such that for all finite-dimensional K -algebras A with $\dim_K(A) \leq d$ and $\text{gl. dim}(A) < \infty$ we have*

$$\text{gl. dim}(A) \leq f(d).$$

Corollary 13.35 (Happel, Zacharia [HZ13]). *Let K be algebraically closed. If $d(Q) < \infty$, then $g(Q) < \infty$.*

As a matter of habit, I upgraded problems and questions in [HZ13] to conjectures.

Conjecture 13.36. *If $g(Q) < \infty$, then $d(Q) < \infty$.*

Here is an even stronger conjecture:

Conjecture 13.37. *$g(Q) < \infty$ and $d(Q) < \infty$.*

Conjecture 13.38. *Assume that $\text{gl. dim}(KQ/I) < \infty$ for some admissible ideal I . Then we have*

$$\text{gl. dim}(KQ/I) \leq \dim_K(KQ/I).$$

One can refine the above conjectures by using

$$g(Q, d) := \sup\{\text{gl. dim}(KQ/I) \mid I \text{ admissible in } KQ, \text{gl. dim}(KQ/I) = d\}$$

and

$$d(Q, d) := \sup\{\dim_K(KQ/I) \mid I \text{ admissible in } KQ, \text{gl. dim}(KQ/I) = d\}$$

with $d \geq 1$.

Proposition 13.39. *If A and B are finite-dimensional K -algebras with*

$$D^b(\text{mod}(A)) \simeq D^b(\text{mod}(B)),$$

then $\text{gl. dim}(A) < \infty$ if and only if $\text{gl. dim}(B) < \infty$.

I learned the following two questions from Martin Kalck [K16].

Question 13.40. Let A and B be finite-dimensional K -algebras with

$$D^b(\text{mod}(A)) \simeq D^b(\text{mod}(B)).$$

Assume that $\text{gl. dim}(A) \leq m \leq \text{gl. dim}(B)$. Is there a finite-dimensional K -algebra C with $\text{gl. dim}(C) = m$ and

$$D^b(\text{mod}(A)) \simeq D^b(\text{mod}(C))?$$

Question 13.41. Let A be a finite-dimensional K -algebra. Is there some $b_A \geq 0$ such that for each finite-dimensional K -algebra B with

$$D^b(\text{mod}(A)) \simeq D^b(\text{mod}(B))$$

we have

$$|\text{gl. dim}(A) - \text{gl. dim}(B)| \leq b_A?$$

Theorem 13.42 ([H87, H88, HR82]). Let $T \in \text{mod}(A)$ be a classical tilting module, and let $B := \text{End}_A(T)^{\text{op}}$. Then

$$|\text{gl. dim}(A) - \text{gl. dim}(B)| \leq 1$$

and

$$D^b(\text{mod}(A)) \simeq D^b(\text{mod}(B)).$$

Conjecture 13.43 (Kalck [K16]). Let K be algebraically closed. Let $\mathbb{X} = \mathbb{X}(p, \lambda)$ be a weighted projective line with weight sequence $p = (p_1, \dots, p_t)$, and let A be a finite-dimensional K -algebra with

$$D^b(\text{coh}(\mathbb{X})) \simeq D^b(\text{mod}(A)).$$

Then

$$\text{gl. dim}(A) \leq \max\{p_i \mid 1 \leq i \leq t\}.$$

Most conjectures and statements in this section should have an analogue in the world of finite-dimensional K -algebras with K an arbitrary field.

LITERATURE - GLOBAL DIMENSION CONJECTURES

- [A55] M. Auslander, *On the dimension of modules and algebras. III. Global dimension*. Nagoya Math. J. 9 (1955), 67–77.
- [DR89] V. Dlab, C.M. Ringel, *Filtrations of right ideals related to projectivity of left ideals*. In: Sem. Malliavin. Springer LNM. 1404, 95–107 (1989).
- [DR90] V. Dlab, C.M. Ringel, *The dimension of a quasi-hereditary algebra*. In: Topics in Algebra. Banach Center Publ. 26 (1990).
- [H87] D. Happel, *On the derived category of a finite-dimensional algebra*. Comment. Math. Helv. 62 (1987), no. 3, 339–389.

- [H88] D. Happel, *Triangulated categories in the representation theory of finite-dimensional algebras*. London Mathematical Society Lecture Note Series, 119. Cambridge University Press, Cambridge, 1988. x+208 pp.
- [HR82] D. Happel, C.M. Ringel, *Tilted algebras*. Trans. Amer. Math. Soc. 274 (1982), no. 2, 399–443.
- [HZ13] D. Happel, D. Zacharia, *Algebras of finite global dimension*. In: Algebras, quivers and representations, 95–113, Abel Symp., 8, Springer, Heidelberg, 2013.
- [K16] M. Kalck, Private communication, January 2016.
- [M18] R. Marczinzik, *On the injective dimension of the Jacobson radical*. Preprint, arXiv:1801.05674
- [S85] A. Schofield, *Bounding the global dimension in terms of the dimension*. Bull. London Math. Soc. 17, no. 4, 393–394 (1985).

13.6. Conjectures on rigid modules. Let A be a finite-dimensional K -algebra.

For $M \in \text{mod}(A)$ let $\text{sd}(M)$ be the number of isomorphism classes of indecomposable direct summands of M . Let $n(A)$ be the number of isomorphism classes of simple A -modules. Recall that we have

$$n(A) = \text{sd}({}_A A) = \text{sd}(D(A_A)).$$

We call $M \in \text{mod}(A)$ **rigid** if

$$\text{Ext}_A^1(M, M) = 0.$$

I found the following conjecture in [K].

Conjecture 13.44. *For each $d \geq 1$ there are only finitely many rigid A -modules of dimension d , up to isomorphism.*

Using a geometric argument, Conjecture 13.44 can be proved provided K is algebraically closed. There is a proof for A hereditary and K arbitrary. It also should not be difficult to prove it in general and probably someone did it already, I just could not find a reference.

An A -module M is **selforthogonal** if

$$\text{Ext}_A^i(M, M) = 0$$

for all $i \geq 1$. (This terminology varies from author to author.)

The following conjecture can be found in [H, H95].

Conjecture 13.45. *Let $M \in \text{mod}(A)$ be selforthogonal. Then we have*

$$\text{sd}(M) \leq n(A).$$

Also the following weaker conjecture from [H, H95] is still unsolved.

Conjecture 13.46. *Let $M \in \text{mod}(A)$ be selforthogonal with $\text{proj. dim}(M) < \infty$. Then we have*

$$\text{sd}(M) \leq n(A).$$

Theorem 13.47 (Bongartz [Bo81]). *Let $M \in \text{mod}(A)$ be selforthogonal with $\text{proj. dim}(M) \leq 1$. Then there exists some $N \in \text{mod}(A)$ such that*

$$\text{sd}(M \oplus N) = n(A) \quad \text{and} \quad \text{proj. dim}(M \oplus N) \leq 1.$$

In particular, we have

$$\text{sd}(M) \leq n(A).$$

There exist finite-dimensional K -algebras A such that for each $m \geq 1$ there exists some $M \in \text{mod}(A)$ with $\text{Ext}_A^1(M, M) = 0$ and $\text{sd}(M) = m$, see [HIO14].

Here is a related problem:

Problem 13.48 (Iyama [I]). *Find a finite-dimensional algebra A and an A -module*

$$M := \bigoplus_{i \in I} M_i$$

such that I is infinite, $M_i \in \text{mod}(A)$ is indecomposable for all i , and $M_i \not\cong M_j$ for all $i \neq j$ such that the following hold:

- (i) $\text{Ext}_A^1(M, M) = 0$.
- (ii) *If $N \in \text{mod}(A)$ is indecomposable with $\text{Ext}_A^1(M, N) = 0$, then $N \cong M_i$ for some i .*
- (iii) *If $N \in \text{mod}(A)$ is indecomposable with $\text{Ext}_A^1(N, M) = 0$, then $N \cong M_i$ for some i .*

Question 13.49 (Tachikawa). *Let A be selfinjective. Let $M \in \text{mod}(A)$ be selforthogonal. Does this imply that M is projective?*

Conjecture 13.50 (Auslander-Reiten [AR75]). *Each selforthogonal generator-cogenerator of $\text{mod}(A)$ is projective.*

Proposition 13.51 (Müller [M68]). *Conjecture 13.50 is true if and only if the Nakayama Conjecture is true.*

Conjecture 13.52 ([AR75]). *Each selforthogonal generator of $\text{mod}(A)$ is projective.*

Proposition 13.53 ([AR75]). *Conjecture 13.52 is true if and only if the Generalized Nakayama Conjecture is true.*

A module $T \in \text{mod}(A)$ is a **tilting module** if the following hold:

- (i) T is selforthogonal;
- (ii) $\text{proj. dim}(T) < \infty$;
- (iii) There exists an exact sequence of the form

$$0 \rightarrow {}_A A \rightarrow T_0 \rightarrow T_1 \rightarrow \cdots \rightarrow T_m \rightarrow 0$$

with $T_i \in \text{add}(T)$ for all $1 \leq i \leq m$.

Proposition 13.54. *For tilting modules T we have*

$$\text{sd}(T) = n(A).$$

In the literature, tilting modules are sometimes called *generalized tilting modules*, whereas the term *tilting module* is used for tilting modules with projective dimension at most one. Tilting modules with projective dimension at most one are also called **classical tilting modules**.

Conjecture 13.55. *Let $M \in \text{mod}(A)$ be a selforthogonal A -module with $\text{proj. dim}(M) < \infty$ and $\text{sd}(M) = n(A)$. Then M is a tilting module.*

Direct summands of tilting modules are called **partial tilting modules**.

There are examples of selforthogonal modules M with $\text{proj. dim}(M) < \infty$ which are not partial tilting modules, see [H, H95].

A partial tilting module $M \in \text{mod}(A)$ with $\text{sd}(M) = n(A) - 1$ is an **almost complete tilting module**. An indecomposable $C \in \text{mod}(A)$ is a **complement** of an almost complete tilting module M if $M \oplus C$ is a tilting module.

Conjecture 13.56. *Let $M \in \text{mod}(A)$ be a projective almost complete tilting module. Then M has only finitely many complements, up to isomorphism.*

For a proof of the following result we refer to [HU98].

Proposition 13.57. *Conjecture 13.56 is true if and only if the Generalized Nakayama Conjecture is true.*

Here is a more general conjecture, see for example [HU98]:

Conjecture 13.58. *Let $M \in \text{mod}(A)$ be an almost complete tilting module. Then M has only finitely many complements, up to isomorphism.*

Theorem 13.59 ([HU89, RS90]). *Let $M \in \text{mod}(A)$ be an almost complete classical tilting module. Then M has at most two complements, up to isomorphism.*

Conjecture 13.60. *Assume that $D(A_A)$ is selforthogonal with $\text{proj. dim}(D(A_A)) < \infty$. Then $D(A_A)$ is a tilting module.*

Conjecture 13.61 (Wakamatsu Tilting Conjecture [W88]). *Let $T \in \text{mod}(A)$ such that the following hold:*

- (i) T is selforthogonal with $\text{proj. dim}(T) < \infty$.
- (ii) There exists an exact sequence

$$0 \rightarrow {}_A A \rightarrow T_0 \xrightarrow{f_0} T_1 \xrightarrow{f_1} T_2 \xrightarrow{f_2} T_3 \xrightarrow{f_3} \dots$$

with $T_i \in \text{add}(T)$ and

$$\text{Im}(f_i) \subseteq \{M \in \text{mod}(A) \mid \text{Ext}_A^j(M, T) = 0 \text{ for all } j \geq 1\}$$

for all $i \geq 0$.

Then T is a tilting module.

LITERATURE - RIGID MODULE CONJECTURES

- [AR75] M. Auslander, I. Reiten, *On a generalized version of the Nakayama conjecture*, Proc. Amer. Math. Soc. 52 (1975), 69–74.
- [Bo81] K. Bongartz, *Tilted algebras*. Representations of algebras (Puebla, 1980), pp. 26–38, Lecture Notes in Math., 903, Springer, Berlin-New York, 1981.
- [H] D. Happel, *Homological conjectures in representation theory of finite-dimensional algebras*. Unpublished note.
- [H95] D. Happel, *Selforthogonal modules*. In: Abelian groups and modules (Padova, 1994), 257–276, Math. Appl., 343, Kluwer Acad. Publ., Dordrecht, 1995
- [HU89] D. Happel, L. Unger, *Almost complete tilting modules*. Proc. Amer. Math. Soc. 107 (1989), no. 3, 603–610.
- [HU98] D. Happel, L. Unger, *Complements and the generalized Nakayama conjecture*, In: Algebras and modules, II (Geiranger, 1996), 293–310, CMS Conf. Proc., 24, Amer. Math. Soc., Providence, RI, 1998
- [HIO14] M. Herschend, O. Iyama, S. Oppermann, *n-representation infinite algebras*, Adv. Math. 252 (2014), 292–342.
- [I] O. Iyama, *Selforthogonal categories*, Unpublished note. Can be found on the FDLIST webpage.
- [K] H. Krause, *The number of exceptional modules of fixed dimension*, Unpublished note. Can be found on the FDLIST webpage.

- [M68] B. Müller, *The classification of algebras by dominant dimension*. Canadian J. Math. 20 (1968), 398–409.
- [RS90] C. Riedtmann, A. Schofield, *On open orbits and their complements*. J. Algebra 130 (1990), no. 2, 388–411.
- [W88] T. Wakamatsu, *On modules with trivial self-extensions*, J. Algebra 114 (1988), no. 1, 106–114.

13.7. Hierarchy of homological conjectures. We display the relation between various homological conjectures:

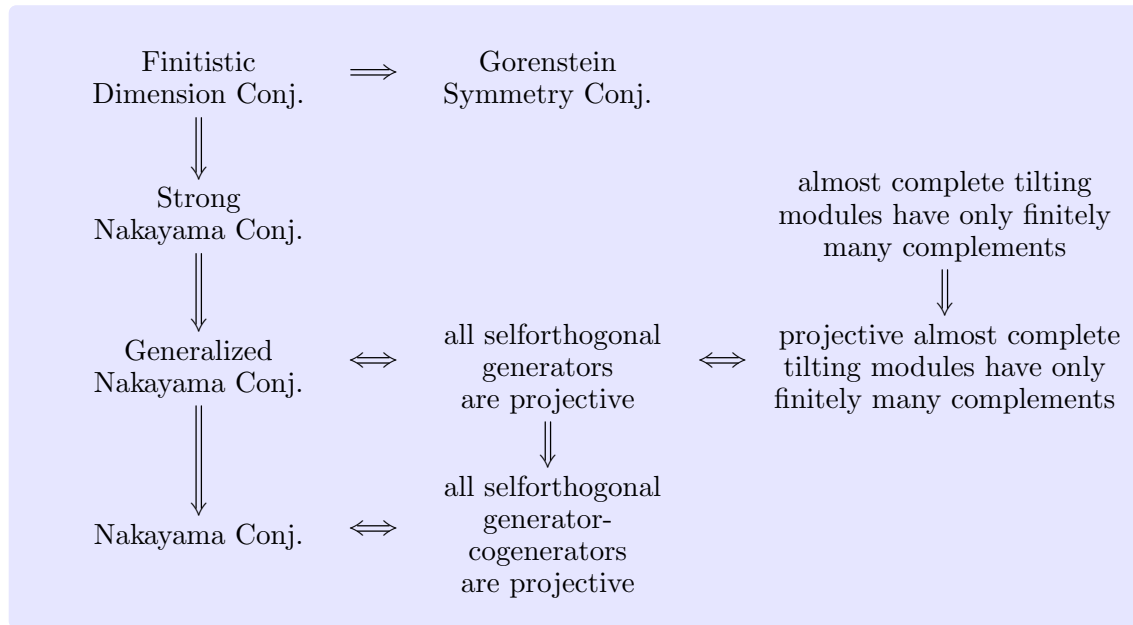

14. Auslander-Reiten theory

Let A be a finite-dimensional K -algebra, and let $\text{mod}(A)$ be the category of finite-dimensional A -modules.

Auslander-Reiten theory provides a homological tool box for studying the category $\text{mod}(A)$. For many representation-finite algebras A it also yields a combinatorial description of $\text{mod}(A)$ via the knitting algorithm and the mesh category.

14.1. Auslander-Reiten sequences.

A homomorphism $f: X \rightarrow Y$ in $\text{mod}(A)$ is a **split monomorphism** if f is a monomorphism and $\text{Im}(f)$ is a direct summand of Y .

A homomorphism $f: X \rightarrow Y$ in $\text{mod}(A)$ is a **split epimorphism** if f is an epimorphism and $\text{Ker}(f)$ is a direct summand of X .

It follows that $f: X \rightarrow Y$ is a split monomorphism (resp. split epimorphism) if and only if there exists some homomorphism $g: Y \rightarrow X$ such that

$$gf = 1_X \quad (\text{resp. } fg = 1_Y).$$

A homomorphism f in $\text{mod}(A)$ is **irreducible** if the following hold:

- (i) f is not a split monomorphism.
- (ii) f is not a split epimorphism.
- (iii) If $f = f_2 f_1$ for some homomorphisms f_1 and f_2 , then f_1 is a split monomorphism or f_2 is a split epimorphism.

Lemma 14.1. *Every irreducible homomorphism in $\text{mod}(A)$ is either injective or surjective.*

A short exact sequence

$$0 \rightarrow X \xrightarrow{f} Y \xrightarrow{g} Z \rightarrow 0$$

in $\text{mod}(A)$ is an **Auslander-Reiten sequence** if f and g are irreducible.

Proposition 14.2. *For $i = 1, 2$ let*

$$\eta_i: 0 \rightarrow X_i \rightarrow Y_i \rightarrow Z_i \rightarrow 0$$

be an Auslander-Reiten sequence in $\text{mod}(A)$. If $X_1 \cong X_2$ or $Z_1 \cong Z_2$, then η_1 and η_2 are isomorphic.

One can characterize Auslander-Reiten sequences in terms of source maps and sink maps.

A homomorphism $f: X \rightarrow Y$ in $\text{mod}(A)$ is **left almost split** if the following hold:

- (i) f is not a split monomorphism.
- (ii) For every homomorphism $h: X \rightarrow M$ which is not a split monomorphism there exists some $h': Y \rightarrow M$ with $h'f = h$.

$$\begin{array}{ccc} X & \xrightarrow{f} & Y \\ h \downarrow & \swarrow h' & \\ M & & \end{array}$$

A homomorphism $f: X \rightarrow Y$ is **left minimal** if all $h \in \text{End}_A(Y)$ with $hf = f$ are automorphisms.

A homomorphism $f: X \rightarrow Y$ is a **source map** for X if the following hold:

- (i) f is left almost split.
- (ii) f is left minimal.

Lemma 14.3. *Let I be an indecomposable injective module. Then the projection*

$$I \rightarrow I/\text{soc}(I)$$

is a source map. Let $X \in \text{ind}(A)$ be non-injective. Then any source map $X \rightarrow Y$ is a monomorphism.

Lemma 14.4. *Source maps are unique up to isomorphism. More precisely, for $X \in \text{mod}(A)$ and $i = 1, 2$ let $f_i: X \rightarrow Y_i$ be source maps. Then there exists an isomorphism $h: Y_1 \rightarrow Y_2$ such that $hf_1 = f_2$.*

A source map $X \rightarrow Y$ contains all irreducible homomorphisms starting in X :

Lemma 14.5. *Let $f: X \rightarrow Y$ be a source map, and let $f': X \rightarrow Y'$ be an arbitrary homomorphism. Then the following are equivalent:*

- (i) *There exists a homomorphism $f'': X \rightarrow Y''$ and an isomorphism $h: Y \rightarrow Y' \oplus Y''$ such that the diagram*

$$\begin{array}{ccc}
 X & \xrightarrow{f} & Y \\
 \left[\begin{array}{c} f' \\ f'' \end{array} \right] \downarrow & & \swarrow h \\
 Y' \oplus Y'' & &
 \end{array}$$

commutes.

- (ii) *f' is irreducible or $Y' = 0$.*

Corollary 14.6. *Non-zero source maps are irreducible.*

Here are the dual definitions and statements:

A homomorphism $g: Y \rightarrow Z$ in $\text{mod}(A)$ is **right almost split** if the following hold:

- (i) g is not a split epimorphism.
- (ii) For every homomorphism $h: N \rightarrow Z$ which is not a split epimorphism there exists some $h': N \rightarrow Y$ with $gh' = h$.

$$\begin{array}{ccc}
 & & N \\
 & \nearrow h' & \downarrow h \\
 Y & \xrightarrow{g} & Z
 \end{array}$$

A homomorphism $g: Y \rightarrow Z$ is **right minimal** if all $h \in \text{End}_A(Y)$ with $gh = g$ are automorphisms.

A homomorphism $g: Y \rightarrow Z$ is a **sink map** for Z if the following hold:

- (i) g is right almost split.
- (ii) g is right minimal.

Lemma 14.7. *Let P be an indecomposable projective module. Then the embedding*

$$\text{rad}(P) \rightarrow P$$

is a sink map. Let $Z \in \text{ind}(A)$ be non-projective. Then any sink map $Y \rightarrow Z$ is an epimorphism.

Lemma 14.8. *Sink maps are unique up to isomorphism.*

A sink map $Y \rightarrow Z$ contains all irreducible homomorphisms ending in Z :

Lemma 14.9. *Let $g: Y \rightarrow Z$ be a sink map, and let $g': Y' \rightarrow Z$ be an arbitrary homomorphism. Then the following are equivalent:*

- (i) *There exists a homomorphism $g'': Y'' \rightarrow Z$ and an isomorphism $h: Y' \oplus Y'' \rightarrow Y$ such that the diagram*

$$\begin{array}{ccc} & Y' \oplus Y'' & \\ & \swarrow h & \downarrow [g', g''] \\ Y & \xrightarrow{g} & Z \end{array}$$

commutes.

- (ii) *g' is irreducible or $Y' = 0$.*

Corollary 14.10. *Non-zero sink maps are irreducible.*

Theorem 14.11. *Let*

$$\eta: 0 \rightarrow X \xrightarrow{f} Y \xrightarrow{g} Z \rightarrow 0$$

be a short exact sequence in $\text{mod}(A)$. Then the following are equivalent.

- (i) *g is right almost split, and X is indecomposable.*
- (ii) *f is left almost split, and Z is indecomposable.*
- (iii) *f is a source map.*
- (iv) *g is a sink map.*
- (v) *η is an Auslander-Reiten sequence.*

14.2. Existence of Auslander-Reiten sequences.

The **stable category** $\underline{\text{mod}}(A)$ has by definition the same objects as $\text{mod}(A)$. The morphisms spaces in $\underline{\text{mod}}(A)$ are

$$\underline{\text{Hom}}_A(X, Y) := \text{Hom}_A(X, Y) / \mathcal{P}(X, Y)$$

where $\mathcal{P}(X, Y)$ is the subspace of all homomorphisms $X \rightarrow Y$ factoring through a projective A -module.

Dually, the **stable category** $\overline{\text{mod}}(A)$ has the same objects as $\text{mod}(A)$. The morphisms spaces in $\overline{\text{mod}}(A)$ are

$$\overline{\text{Hom}}_A(X, Y) := \text{Hom}_A(X, Y) / \mathcal{I}(X, Y)$$

where $\mathcal{I}(X, Y)$ is the subspace of all homomorphisms $X \rightarrow Y$ factoring through an injective A -module.

Stable categories are in general not abelian, but there are some interesting exceptions.

If A is selfinjective, then $\underline{\text{mod}}(A)$ is a triangulated category with the shift given by the inverse syzygy functor Ω_A^{-1} .

Let $\nu_A := D \text{Hom}_A(-, {}_A A)$ and $\nu_A^{-1} := \text{Hom}_A(D({}_A A), -)$. These functors are the **Nakayama functors** and give rise to equivalences

$$\text{proj}(A) \begin{array}{c} \xrightarrow{\nu_A} \\ \xleftarrow{\nu_A^{-1}} \end{array} \text{inj}(A)$$

which are quasi-inverses of each other.

For $M \in \text{mod}(A)$ let

$$P_1 \xrightarrow{f} P_0 \rightarrow M \rightarrow 0$$

be a minimal projective presentation. Define

$$\tau_A(M) := \text{Ker}(\nu_A(f)).$$

Dually, for $M \in \text{mod}(A)$ let

$$0 \rightarrow M \rightarrow I_0 \xrightarrow{f} I_1$$

be a minimal injective presentation. Define

$$\tau_A^{-1}(M) := \text{Cok}(\nu_A^{-1}(f)).$$

One calls τ_A and τ_A^{-1} **Auslander-Reiten translations**.

The AR translations τ_A and τ_A^{-1} induce bijections

$$\{[X] \mid X \in \text{ind}(A) \text{ non-projective}\} \xrightleftharpoons[\tau_A^{-1}]{\tau_A} \{[X] \mid X \in \text{ind}(A) \text{ non-injective}\}$$

which are inverses of each other. (Here $[X]$ denotes the isomorphism class of X .)

Theorem 14.12 (Auslander, Reiten [SY11, Chapter III, Corollary 4.8]). *The Auslander-Reiten translations τ_A and τ_A^{-1} induce equivalences*

$$\underline{\text{mod}}(A) \xrightleftharpoons[\tau_A^{-1}]{\tau_A} \overline{\text{mod}}(A)$$

which are quasi-inverses of each other.

Theorem 14.13 (Auslander-Reiten formulas [SY11, Chapter III, Theorem 6.3]). *For $X, Y \in \text{mod}(A)$ we have functorial isomorphisms*

$$D\overline{\text{Hom}}_A(Y, \tau_A(X)) \cong \text{Ext}_A^1(X, Y) \cong D\underline{\text{Hom}}_A(\tau_A^{-1}(Y), X).$$

For $X \in \text{ind}(A)$ let

$$\underline{\text{End}}_A(X) := \text{End}_A(X) / \mathcal{P}(X, X).$$

If X is projective, then $\underline{\text{End}}_A(X) = 0$. Otherwise, we have $\mathcal{P}(X, X) \subseteq J(\text{End}_A(X))$.

We have

$$D\underline{\text{End}}_A(X) = \{f \in D\text{End}_A(X) \mid f(\mathcal{P}(X, X)) = 0\}.$$

The Auslander-Reiten formulas lead to the following groundbreaking existence theorems:

Theorem 14.14 (Existence of Auslander-Reiten sequences [SY11, Chapter III, Theorem 8.4]). *Let $X \in \text{ind}(A)$ be non-projective. We have a functorial isomorphism*

$$\eta: D\underline{\text{End}}_A(X) \rightarrow \text{Ext}_A^1(X, \tau_A(X)).$$

Let $0 \neq f \in D\text{End}_A(X)$ with $f(J(\text{End}_A(X))) = 0$. Then

$$\eta(f): 0 \rightarrow \tau_A(X) \rightarrow F \rightarrow X \rightarrow 0$$

is an Auslander-Reiten sequence.

14.3. Translation quivers. Let $(\Gamma_0, \Gamma_1, s, t)$ be a quiver. In contrast to our usual convention, we now allow Γ_0 and Γ_1 to be infinite sets. As before, we allow multiple arrows between vertices. We call $(\Gamma_0, \Gamma_1, s, t)$ **locally finite** if for each vertex y there are at most finitely many arrows ending at y and there are at most finitely many arrows starting at y .

A **loop** is an arrow $a \in \Gamma_1$ with $s(a) = t(a)$.

A six-tuple $\Gamma = (\Gamma_0, \Gamma_1, s, t, \tau, \sigma)$ is a **translation quiver** if the following hold:

- (T1) $(\Gamma_0, \Gamma_1, s, t)$ is a locally finite quiver without loops;
- (T2) $\tau: \Gamma'_0 \rightarrow \Gamma_0$ is an injective map where Γ'_0 is a subset of Γ_0 , and for all $z \in \Gamma'_0$ and $y \in \Gamma_0$ the number of arrows $y \rightarrow z$ equals the number of arrows $\tau(z) \rightarrow y$;
- (T3) $\sigma: \Gamma'_1 \rightarrow \Gamma_1$ is an injective map with $\sigma(\alpha): \tau(z) \rightarrow y$ for each $\alpha: y \rightarrow z$, where Γ'_1 is the set of all arrows $\alpha: y \rightarrow z$ with $z \in \Gamma'_0$.

If $\Gamma = (\Gamma_0, \Gamma_1, s, t, \tau, \sigma)$ is a translation quiver, then τ is called the **translation** of Γ . The vertices in $\Gamma_0 \setminus \Gamma'_0$ are the **projective vertices**, and $\Gamma_0 \setminus \tau(\Gamma'_0)$ is the set of **injective vertices**. The map τ yields a bijection $\Gamma'_0 \rightarrow \tau(\Gamma'_0)$ from the set of non-projective to the set of non-injective vertices. The inverse map is denoted by τ^{-1} .

If there is an arrow $x \rightarrow y$ in a quiver Γ , then x is called a **direct predecessor** of y , and y is a **direct successor** of x . Recall that a **path** of length $n \geq 1$ in Γ is an n -tuple $w = (a_1, \dots, a_n)$ of arrows in Γ such that $s(a_i) = t(a_{i+1})$ for $1 \leq i \leq n - 1$. We say that w **starts** in $s(w) := s(a_n)$, and w **ends** in $t(w) := t(a_1)$. Additionally, for each vertex x of Γ there is a path 1_x of length 0 with $s(1_x) = t(1_x) = x$.

We write

$$x \xrightarrow{m} y$$

for indicating that there are exactly m arrows $x \rightarrow y$. We draw a dashed arrow

$$x \leftarrow - - z$$

to indicate that $x = \tau(z)$.

By condition (T2) we know that each non-projective vertex z of Γ yields a full subquiver of the form

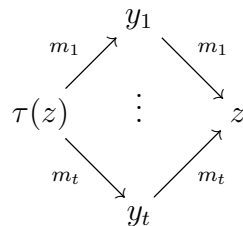

where y_1, \dots, y_t are the direct predecessors of z in Γ , and $m_i \geq 1$ for $1 \leq i \leq t$. Such a subquiver is called a **mesh** in Γ . By (T2) and (T3) the map σ yields a bijection between the set of arrows $y_i \rightarrow z$ and the set of arrows $\tau(z) \rightarrow y_i$ for each $1 \leq i \leq t$.

If Γ does not have any projective or injective vertices, then Γ is **stable**.

Connected components (with respect to arrows and dashed arrows) of translation quivers are again translation quivers in the obvious way.

Example: The following translation quiver is finite and has just one connected component. Its projective vertices are 1, 2, 3, 4 and its injective vertices are 4, 7, 8, 9.

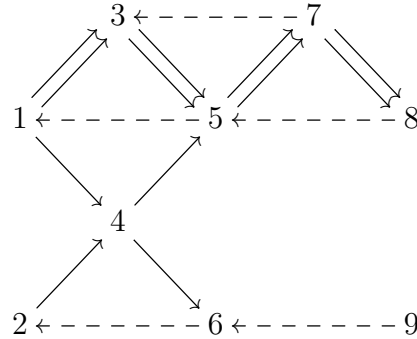

(We do not specify the map σ . It gives a bijection between the two arrows $3 \rightarrow 5$ and the two arrows $1 \rightarrow 3$, etc.)

14.4. Mesh category of a translations quiver. Let $\Gamma = (\Gamma_0, \Gamma_1, s, t, \tau, \sigma)$ be a translation quiver.

The **path category** $K\Gamma$ of Γ has the vertices of Γ as objects. For vertices $x, y \in \Gamma_0$ the morphism space $\text{Hom}_{K\Gamma}(x, y)$ has a K -basis indexed by the paths in Γ which start in x and end in y . There is a path 1_x of length 0 which is the identity element for x . The K -bilinear composition is defined via the usual composition of paths in quivers.

For each non-projective vertex z we call the linear combination

$$\rho_z := \sum_{\alpha: y \rightarrow z} \alpha \sigma(\alpha)$$

the **mesh relation** associated to z , where the sum runs over all arrows ending in z .

By definition, ρ_z is a morphism in the path category $K\Gamma$.

The **mesh category** $K\langle\Gamma\rangle$ of the translation quiver Γ is by definition the factor category of $K\Gamma$ modulo the ideal \mathcal{M}_Γ generated by all mesh relations ρ_z , where z runs through the set Γ'_0 of all non-projective vertices of Γ .

Example: Let Γ be the translation quiver

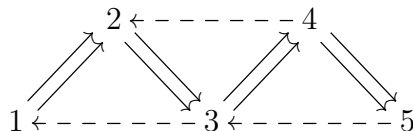

(We do not specify σ .) For $1 \leq i, j \leq 5$ we get

$$\dim \text{Hom}_{K\Gamma}(i, j) = \begin{cases} 2^{j-i} & \text{if } j \geq i, \\ 0 & \text{otherwise.} \end{cases}$$

$$\dim \text{Hom}_{K\langle\Gamma\rangle}(i, j) = \begin{cases} j - i + 1 & \text{if } j \geq i, \\ 0 & \text{otherwise.} \end{cases}$$

14.5. Valued translation quivers.

Assume that $\Gamma = (\Gamma_0, \Gamma_1, s, t, \tau, \sigma)$ is a translation quiver without multiple arrows. A function

$$d: \Gamma_0 \cup \Gamma_1 \rightarrow \mathbb{N}_1$$

is a **valuation** for Γ if the following hold:

- (V1) If $\alpha: x \rightarrow y$ is an arrow, then $d(x)$ and $d(y)$ divide $d(\alpha)$;
- (V2) We have $d(\tau(z)) = d(z)$ and $d(\tau(z) \rightarrow y) = d(y \rightarrow z)$ for every non-projective vertex z and every arrow $y \rightarrow z$.

If d is a valuation for Γ , then we call (Γ, d) a **valued translation quiver**.

If d is a valuation for Γ with $d(x) = 1$ for all vertices x of Γ , then d **splits**.

Let (Γ, d) be a valued translation quiver such that d splits. Then we define the **expansion** $(\Gamma, d)^e$ of Γ as follows: The quiver $(\Gamma, d)^e$ has the same vertices as (Γ, d) , and also the same translation τ . For every arrow $\alpha: x \rightarrow y$ in Γ , we get a sequence of $d(x \rightarrow y)$ arrows $\alpha^i: x \rightarrow y$ where $1 \leq i \leq d(\alpha)$. (Thus the arrows in $(\Gamma, d)^e$ starting in x and ending in y are enumerated, there is a first arrow, a second arrow, etc.) Now σ sends the i th arrow $y \rightarrow z$ to the i th arrow $\tau(z) \rightarrow y$ provided z is a non-projective vertex.

A **valued quiver** is a valued translation quiver which only has projective vertices. In particular, we allow that a valued quiver is infinite.

Let Δ be a valued quiver. We define a valued translations quiver $\mathbb{Z}\Delta$ as follows: The vertices of $\mathbb{Z}\Delta$ are

$$\{x[i] \mid x \in \Delta_0, i \in \mathbb{Z}\}.$$

For each arrow $a: x \rightarrow y$ in Δ_1 there are arrows

$$a[i]: x[i] \rightarrow y[i] \quad \text{and} \quad a'[i]: y[i] \rightarrow x[i+1]$$

for all $i \in \mathbb{Z}$. For $x \in \Delta_0$ and $i \in \mathbb{Z}$ define

$$\tau(x[i+1]) := x[i].$$

Let d be the valuation for Δ . The valuation $d_{\mathbb{Z}}$ for $\mathbb{Z}\Delta$ is defined by $d_{\mathbb{Z}}(x[i]) := d(x)$, $d_{\mathbb{Z}}(a[i]) := d(a)$ and $d_{\mathbb{Z}}(a'[i]) := d(a)$ for all $x \in \Delta_0$, $a \in \Delta_1$ and $i \in \mathbb{Z}$.

Example: Let Δ be the valued quiver

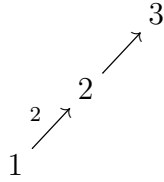

where the valuation for the vertices is $d_1 = d_3 = 1$ and $d_2 = 2$. Then $\mathbb{Z}\Delta$ is

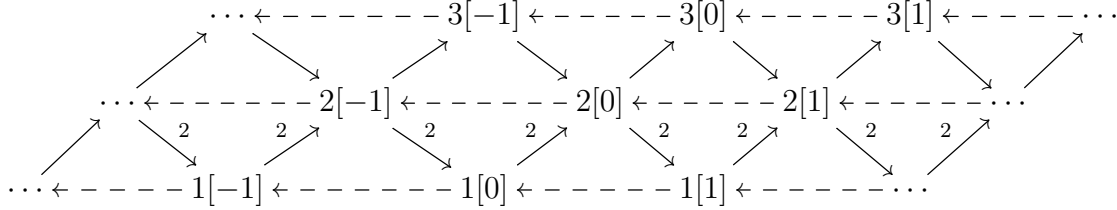

where the valuation for the vertices is $d_{1[i]} = d_{3[i]} = 1$ and $d_{2[i]} = 2$.

For a valued quiver Δ let G be a group of automorphisms of the valued translation quiver $\mathbb{Z}\Delta$. (Such an automorphism is defined in the obvious way. It is compatible with the translation τ and with the valuation d for $\mathbb{Z}\Delta$.) For a vertex x and an arrow a of $\mathbb{Z}\Delta$, let $[x]$ and $[a]$ be their G -orbits.

Let $\mathbb{Z}\Delta/G$ be the valued translation quiver with vertices the G -orbits $[x]$, with arrows

$$[a]: [s(a)] \rightarrow [t(a)],$$

and with

$$\tau([x]) := [\tau(x)].$$

The valuation for $\mathbb{Z}\Delta/G$ is defined by $d([x]) := d(x)$ and $d([a]) := d(a)$.

14.6. Radical of a module category.

For $X, Y \in \text{ind}(A)$ let

$$\text{rad}_A(X, Y) := \{f \in \text{Hom}_A(X, Y) \mid f \text{ is not invertible}\}.$$

In particular, if $X \not\cong Y$, then $\text{rad}_A(X, Y) = \text{Hom}_A(X, Y)$. If $X = Y$, then

$$\text{rad}_A(X, X) = \text{rad}(\text{End}_A(X)) = J(\text{End}_A(X))$$

is the Jacobson radical of $\text{End}_A(X)$.

Now let

$$X = \bigoplus_{i=1}^s X_i \quad \text{and} \quad Y = \bigoplus_{j=1}^t Y_j$$

with $X_i, Y_j \in \text{ind}(A)$ for all i and j . Recall that we can think of a homomorphism $f: X \rightarrow Y$ as a matrix

$$f = \begin{pmatrix} f_{11} & \cdots & f_{1s} \\ \vdots & & \vdots \\ f_{t1} & \cdots & f_{ts} \end{pmatrix}$$

where $f_{ji}: X_i \rightarrow Y_j$ is a homomorphism for all i and j .

Set

$$\text{rad}_A(X, Y) := \begin{pmatrix} \text{rad}_A(X_1, Y_1) & \cdots & \text{rad}_A(X_s, Y_1) \\ \vdots & & \vdots \\ \text{rad}_A(X_1, Y_t) & \cdots & \text{rad}_A(X_s, Y_t) \end{pmatrix}.$$

This definition does not depend on the chosen direct sum decompositions of X and Y .

Lemma 14.15. *For $X, Y \in \text{mod}(A)$ the following are equivalent:*

- (i) $f \in \text{rad}_A(X, Y)$.
- (ii) For each $g \in \text{Hom}_A(Y, X)$ the map $1_X - gf$ is an isomorphism.

Let $X, Y \in \text{mod}(A)$. Define $\text{rad}_A^0(X, Y) := \text{Hom}_A(X, Y)$, $\text{rad}_A^1(X, Y) := \text{rad}_A(X, Y)$, and for $m \geq 2$ let $\text{rad}_A^m(X, Y)$ be the homomorphisms $f \in \text{Hom}_A(X, Y)$ such that $f = hg$ for some $g \in \text{rad}_A^{m-1}(X, C)$, $h \in \text{rad}_A(C, Y)$ and $C \in \text{mod}(A)$.

Let

$$\text{rad}_A^\infty(X, Y) := \bigcap_{m \geq 0} \text{rad}_A^m(X, Y)$$

be the **infinite radical** of $\text{mod}(A)$.

Lemma 14.16. *For $m \in \mathbb{N} \cup \{\infty\}$, the map*

$$(X, Y) \mapsto \text{rad}_A^m(X, Y)$$

defines an ideal rad_A^m in $\text{mod}(A)$. In particular, $\text{rad}_A^m(X, Y)$ is a subspace of $\text{Hom}_A(X, Y)$.

The next result follows from a bit of Auslander-Reiten theory together with the Harada-Sai Lemma.

Theorem 14.17. *Let A be representation-finite. Then*

$$\text{rad}_A^\infty = 0.$$

Lemma 14.18. *For $X, Y \in \text{ind}(A)$ and $f \in \text{Hom}_A(X, Y)$ the following are equivalent:*

- (i) f is irreducible.
- (ii) $f \in \text{rad}_A(X, Y) \setminus \text{rad}_A^2(X, Y)$.

14.7. Bimodules of irreducible homomorphisms.

For $X, Y \in \text{ind}(A)$ define

$$\text{Irr}_A(X, Y) := \text{rad}_A(X, Y) / \text{rad}_A^2(X, Y).$$

We call $\text{Irr}_A(X, Y)$ the **bimodule of irreducible maps** from X to Y .

Warning: One has to keep in mind that the elements in $\text{Irr}_A(X, Y)$ are not maps. They are residue classes of maps.

For $X \in \text{ind}(A)$ let

$$F(X) := \text{End}_A(X) / \text{rad}(\text{End}_A(X)).$$

It follows that $F(X)$ is a finite-dimensional K -skew field.

Lemma 14.19. *$\text{Irr}_A(X, Y)$ is an $F(Y)$ - $F(X)$ -bimodule.*

Lemma 14.20. *Assume K is algebraically closed. If X is an indecomposable A -module, then*

$$F(X) \cong K.$$

Theorem 14.21. *Let $X, Y \in \text{ind}(A)$, and let $f: X \rightarrow E$ be a source map for X . Write*

$$E = Y^s \oplus E'$$

with s maximal. Thus $f = {}^t[f_1, \dots, f_s, f']$ where $f_i: X \rightarrow Y$, $1 \leq i \leq s$ and $f': X \rightarrow E'$ are homomorphisms. Then the following hold:

- (i) *The residue classes of f_1, \dots, f_s in $\text{Irr}_A(X, Y)$ form a basis of the $F(Y)$ -vector space $\text{Irr}_A(X, Y)$;*
- (ii) *We have*

$$s = \dim_{F(Y)}(\text{Irr}_A(X, Y)) = \frac{\dim_K(\text{Irr}_A(X, Y))}{\dim_K(F(Y))}.$$

Here is the corresponding result for sink maps:

Theorem 14.22. *Let $X, Y \in \text{ind}(A)$, and let $g: E \rightarrow Y$ be a sink map for Y . Write*

$$E = X^t \oplus E'$$

with t maximal. Thus $g = [g_1, \dots, g_t, g']$ where $g_i: X \rightarrow Y$, $1 \leq i \leq t$ and $g': E' \rightarrow Y$ are homomorphisms. Then the following hold:

- (i) *The residue classes of g_1, \dots, g_t in $\text{Irr}_A(X, Y)$ form a basis of the $F(X)$ -vector space $\text{Irr}_A(X, Y)$;*
- (ii) *We have*

$$t = \dim_{F(X)}(\text{Irr}_A(X, Y)) = \frac{\dim_K(\text{Irr}_A(X, Y))}{\dim_K(F(X))}.$$

Corollary 14.23. *Let*

$$0 \rightarrow \tau_A(X) \rightarrow E \rightarrow X \rightarrow 0$$

be an Auslander-Reiten sequence, and let $Y \in \text{ind}(A)$. Then

$$\dim_K \text{Irr}_A(\tau_A(X), Y) = \dim_K \text{Irr}_A(Y, X).$$

Lemma 14.24. *Let $X \in \text{ind}(A)$ be non-projective. Then*

$$F(\tau_A(X)) \cong F(X).$$

14.8. Auslander-Reiten quivers. Let A be a finite-dimensional K -algebra. For an A -module X denote its isomorphism class by $[X]$. Recall that for $X, Y \in \text{ind}(A)$ we defined

$$F(X) := \text{End}_A(X) / \text{rad}(\text{End}_A(X)) \quad \text{and} \quad \text{Irr}_A(X, Y) := \text{rad}_A(X, Y) / \text{rad}_A^2(X, Y).$$

Let τ_A be the Auslander-Reiten translation for A .

The **Auslander-Reiten quiver** $\Gamma_A = (\Gamma_0, \Gamma_1, s, t)$ of A has as vertices

$$\Gamma_0 := \{[X] \mid X \in \text{ind}(A)\}.$$

For $X, Y \in \text{ind}(A)$ there is an arrow $[X] \rightarrow [Y]$ if and only if $\text{Irr}_A(X, Y) \neq 0$.

Let

$$\Gamma'_0 := \{[X] \in \Gamma_0 \mid X \text{ is non-projective}\}$$

and define

$$\begin{aligned} \tau: \Gamma'_0 &\rightarrow \Gamma_0 \\ [X] &\mapsto [\tau_A(X)]. \end{aligned}$$

For $[X] \in \Gamma'_0$ we draw a dotted arrow $[\tau_A(X)] \leftarrow \cdots [X]$.

For each vertex $[X]$ of Γ_A define

$$d_X := d_A([X]) := \dim_K F(X),$$

and for each arrow $[X] \rightarrow [Y]$ let

$$d_{XY} := d_A([X] \rightarrow [Y]) := \dim_K \text{Irr}_A(X, Y).$$

Arrows in Γ_A are displayed as $[X] \xrightarrow{d_{XY}} [Y]$.

Lemma 14.25. *The following hold:*

- (i) (Γ_A, d_A) is a valued translation quiver.
- (ii) The valuation d_A splits if and only if for each $X \in \text{ind}(A)$ we have $F(X) \cong K$.
- (iii) A vertex $[X]$ of (Γ_A, d_A) is projective (resp. injective) if and only if X is projective (resp. injective).

Lemma 14.26. *If K is algebraically closed, then d_A splits.*

Examples of Auslander-Reiten quivers can be found in Section 14.12.

14.9. Components of Auslander-Reiten quivers. Connected components of Auslander-Reiten quivers are just called **components**.

Theorem 14.27 (Auslander). *Assume that A is connected. Then the following are equivalent:*

- (i) A is representation-finite.
- (ii) Γ_A has a finite component.
- (iii) There is a component \mathcal{C} of Γ_A and some $b \geq 1$ such that

$$\text{length}(X) \leq b$$
 for all $[X] \in \mathcal{C}$.

The following two conjectures are from the list of conjectures in [ARS97].

Conjecture 14.28. *Assume that Γ_A has only one connected component. Then A is representation-finite.*

Conjecture 14.29. *Assume that A is representation-infinite. Then Γ_A has infinitely many connected components.*

I found the following conjecture in [Bu].

Conjecture 14.30. *Let K be algebraically closed. Assume there is some $X \in \text{ind}(A)$ such that*

$$\lim_{n \rightarrow \infty} \sqrt[n]{\text{length}(\tau_A^n(X))} > 1 \quad \text{or} \quad \lim_{n \rightarrow \infty} \sqrt[n]{\text{length}(\tau_A^{-n}(X))} > 1.$$

Then A is wild.

For a component \mathcal{C} of the Auslander-Reiten quiver Γ_A let $\text{ind}(\mathcal{C})$ be the full subcategory of $\text{ind}(A)$ with objects a set of representatives of isomorphism classes of all X with $[X] \in \mathcal{C}$. For $X \in \text{ind}(A)$ we often just write $X \in \mathcal{C}$ if $[X] \in \mathcal{C}$, and we write \mathcal{C} instead of $\text{ind}(\mathcal{C})$. Thus we treat \mathcal{C} (or any set of components of Γ_A) as a full subcategory of $\text{ind}(A)$ and $\text{mod}(A)$.

Assume that the induced valuation for \mathcal{C} splits, and let \mathcal{C}^e be the expansion of \mathcal{C} . Then \mathcal{C} is **standard** if the mesh category $K\langle \mathcal{C}^e \rangle$ is isomorphic to $\text{ind}(\mathcal{C})$.

In this case, the mesh category $K\langle \mathcal{C}^e \rangle$ provides a combinatorial description of $\text{ind}(\mathcal{C})$.

\mathcal{C} is **generalized standard** if

$$\text{rad}_A^\infty(X, Y) = 0$$

for all $X, Y \in \mathcal{C}$.

Proposition 14.31 (Liu [L94]). *Let K be algebraically closed. Then any standard component of Γ_A is generalized standard.*

The τ -orbit of $X \in \Gamma_A$ is

$$\{\tau^i(X) \mid i \in \mathbb{Z}\}$$

\mathcal{C} is **preprojective** (resp. **preinjective**) if the following hold:

- (i) \mathcal{C} contains no oriented cycles.
- (ii) Each $X \in \mathcal{C}$ belongs to the τ -orbit of a projective (resp. injective) module.

$X \in \text{ind}(A)$ is **preprojective** (resp. **preinjective**) if $[X]$ lies in a preprojective (resp. preinjective) component of Γ_A .

Theorem 14.32. *Assume that \mathcal{C} is preprojective or preinjective, and assume that the induced valuation for \mathcal{C} splits. Then \mathcal{C} is standard.*

\mathcal{C} is **regular** if it does not contain any projective or injective module, i.e.

$$\mathcal{C} \cap \text{proj}(A) = \emptyset \quad \text{and} \quad \mathcal{C} \cap \text{inj}(A) = \emptyset.$$

\mathcal{C} is **semiregular** if it does not contain both a projective and an injective module, i.e. we have

$$\mathcal{C} \cap \text{proj}(A) = \emptyset \quad \text{or} \quad \mathcal{C} \cap \text{inj}(A) = \emptyset.$$

\mathcal{C} is a **semiregular tube** if \mathcal{C} is semiregular and it contains an oriented cycle.

The shapes of semiregular tubes and semiregular components were described by Liu [L93]. This extends work by Zhang [Z91].

A path

$$X_1 \rightarrow X_2 \rightarrow \cdots \rightarrow X_t$$

in Γ_A is a **sectional path** if

$$X_i \not\cong \tau(X_{i+2})$$

for $1 \leq i \leq t - 2$.

Sectional paths are an important combinatorial tool for analyzing Auslander-Reiten quivers.

There are examples of Auslander-Reiten components $\mathcal{C} \cong \mathbb{Z}\Delta$ where Δ is one of the following three quivers:

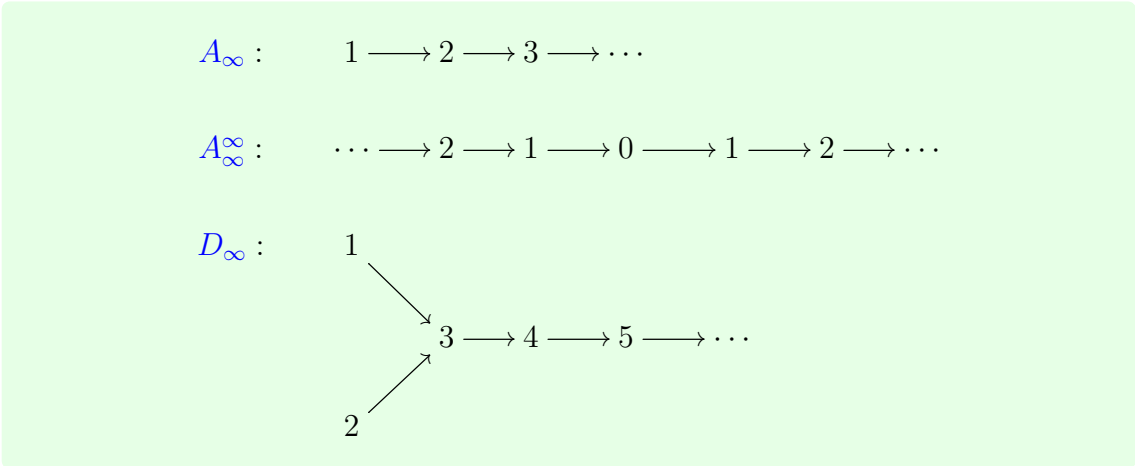

\mathcal{C} is a **stable tube** of **rank** $r \geq 1$ if

$$\mathcal{C} \cong \mathbb{Z}A_\infty / (\tau^r).$$

A stable tube of rank 1 is a **homogeneous tube**.

The following picture shows a stable tube of rank 3 (one needs to identify the vertices on the two dashed vertical lines):

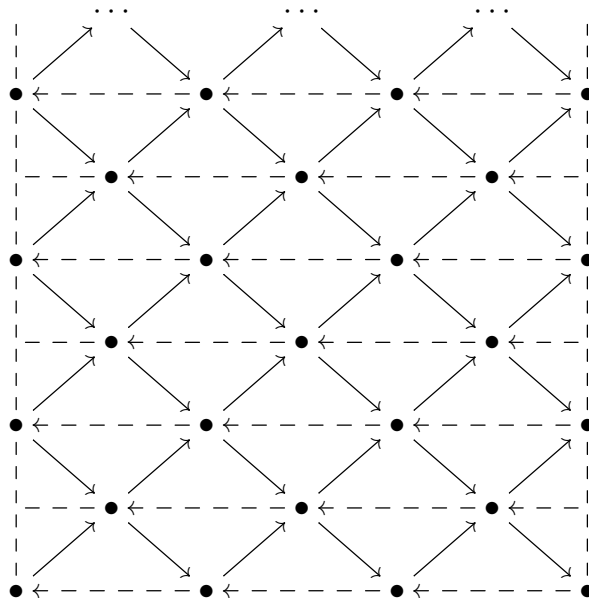

Theorem 14.33 (Skowroński [S94]). *There is only a finite number of generalized standard components of Γ_A which are not stable tubes.*

The **stable Auslander-Reiten quiver** ${}_s\Gamma_A$ is obtained from Γ_A by deleting the τ -orbits which contain a projective or injective module.

This is again a valued translation quiver in the obvious way.

A **stable component** of Γ_A is by definition a component of the stable Auslander-Reiten quiver ${}_s\Gamma_A$.

Note that each regular component is a stable component.

$X \in \mathcal{C}$ is **τ -periodic** if $\tau^r(X) = X$ for some $r \geq 1$.

\mathcal{C} is **periodic** if each $X \in \mathcal{C}$ is τ -periodic. Otherwise, \mathcal{C} is **non-periodic**.

Proposition 14.34. *Assume that \mathcal{C} is a stable component of Γ_A . Suppose there exists some periodic $X \in \mathcal{C}$. Then \mathcal{C} is periodic.*

Theorem 14.35 (Happel, Preiser, Ringel [HPR80]). *Let \mathcal{C} be a stable component of Γ_A . If \mathcal{C} contains a τ -periodic module, then the following hold:*

(i) *If \mathcal{C} is infinite, then*

$$\mathcal{C} \cong \mathbb{Z}A_\infty / (\tau^r)$$

for some $r \geq 1$.

(ii) *If \mathcal{C} is finite, then*

$$\mathcal{C} \cong \mathbb{Z}\Delta / G$$

where Δ is a valued quiver of Dynkin type and G is a group of automorphisms of $\mathbb{Z}\Delta$ containing the automorphism τ^r for some $r \geq 1$.

Theorem 14.36 (Zhang [Z91]). *Let \mathcal{C} be a stable component of Γ_A . If \mathcal{C} does not contain a τ -periodic module, then*

$$\mathcal{C} \cong \mathbb{Z}\Delta$$

where Δ is a valued acyclic quiver.

Both theorems were proved by combinatorial methods.

Problem 14.37 (Ringel [R02, Problem 6]). *Assume that A is 1-domestic. Are all but finitely many components of Γ_A homogeneous tubes?*

Problem 14.38 (Ringel [R02, Problem 5]). Assume that A is tame. Let \mathcal{C} be a regular component of Γ_A which is not a stable tube. Does it follow that

$$\mathcal{C} \cong \mathbb{Z}A_\infty \quad \text{or} \quad \mathcal{C} \cong \mathbb{Z}D_\infty?$$

Theorem 14.39 (Liu [L96]). Assume that a stable component \mathcal{C} of Γ_A contains a τ -orbit with infinitely many modules of the same length. Then

$$\mathcal{C} \cong \mathbb{Z}A_\infty.$$

Conjecture 14.40 (Liu [L96, Problem 2]). Assume that a stable component \mathcal{C} of Γ_A contains infinitely many modules of the same length. Then

$$\mathcal{C} \cong \mathbb{Z}A_\infty.$$

We follow now [Bu]. Let

$$\eta : \quad 0 \rightarrow \tau_A(M) \rightarrow \bigoplus_{i=1}^t E_i \rightarrow M \rightarrow 0$$

be an Auslander-Reiten sequence in $\text{mod}(A)$ with E_i indecomposable for all $1 \leq i \leq t$. In this case, set $\text{sd}(\eta) := t$.

Theorem 14.41. Assume that $\text{sd}(\eta) \geq 2$ and $E_1 \cong E_2$. Then the following hold:

- (i) A is representation infinite.
- (ii) If $\text{sd}(\eta) \geq 4$, then A is wild.
- (iii) If $\text{sd}(\eta) = 3$ and E_3 is not projective-injective, then A is wild.

Theorem 14.42 (Bautista, Brenner [BB81]). If A is representation-finite, then

$$\text{sd}(\eta) \leq 4.$$

In this case, if $\text{sd}(\eta) = 4$, then one the E_i is projective-injective.

The following conjecture is due to Brenner. Some special cases are considered in [PT99].

Conjecture 14.43 (Five Terms in the Middle Conjecture). If A is tame, then

$$\text{sd}(\eta) \leq 5.$$

In this case, if $\text{sd}(\eta) = 5$, then one the E_i is projective-injective.

For $n \geq 2$, the path algebra of the n -Kronecker quiver

$$1 \begin{array}{c} \xrightarrow{a_1} \\ \cdots \\ \xrightarrow{a_n} \end{array} 2$$

is an example of a representation-infinite algebra with $\text{sd}(\eta) \leq n$ for all Auslander-Reiten sequences η . (Recall that the n -Kronecker quiver is tame for $n = 2$ and strictly wild for $n \geq 3$.)

LITERATURE – AUSLANDER-REITEN QUIVERS

- [ASS06] I. Assem, D. Simson, A. Skowroński, *Elements of the representation theory of associative algebras. Vol. 1. Techniques of representation theory*. London Mathematical Society Student Texts, 65. Cambridge University Press, Cambridge, 2006. x+458 pp.
- [ARS97] M. Auslander, I. Reiten, S. Smalø, *Representation theory of Artin algebras*. Corrected reprint of the 1995 original. Cambridge Studies in Advanced Mathematics, 36. Cambridge University Press, Cambridge, 1997. xiv+425 pp.
- [BB81] R. Bautista, S. Brenner, *On the number of terms in the middle of an almost split sequence*. Representations of algebras (Puebla, 1980), pp. 1–8, Lecture Notes in Math., 903, Springer, Berlin-New York, 1981.
- [BCBLZ00] R. Bautista, W. Crawley-Boevey, T. Lei, Y. Zhang, *On homogeneous exact categories*. J. Algebra 230 (2000), no. 2, 665–675.
- [Bu] M.C.R. Butler, *Some conjectures and problems in the representation theory of algebras*. Unpublished note. Can be found on the FDLIST webpage. (Maybe not anymore...)
- [CB88] W. Crawley-Boevey, *On tame algebras and bocses*. Proc. London Math. Soc. (3) 56 (1988), no. 3, 451–483.
- [HPR80] D. Happel, U. Preiser, C.M. Ringel, *Vinberg’s characterization of Dynkin diagrams using subadditive functions with application to DTr-periodic modules*. Representation theory, II (Proc. Second Internat. Conf., Carleton Univ., Ottawa, Ont., 1979), pp. 280–294, Lecture Notes in Math., 832, Springer, Berlin, 1980.
- [K94] H. Krause, *On the four terms in the middle theorem for almost split sequences*. Arch. Math. (Basel) 62 (1994), no. 6, 501–505.
- [L92] S. Liu, *Degrees of irreducible maps and the shapes of Auslander-Reiten quivers*. J. London Math. Soc. (2) 45 (1992), no. 1, 32–54.
- [L93] S. Liu, *Semi-stable components of an Auslander-Reiten quiver*. J. London Math. Soc. (2) 47 (1993), no. 3, 405–416.
- [L94] S. Liu, *Infinite radicals in standard Auslander-Reiten components*. J. Algebra 166 (1994), no. 2, 245–254.
- [L96] S. Liu, *Shapes of connected components of the Auslander-Reiten quivers of Artin algebras*. In: Representation theory of algebras and related topics (Mexico City, 1994), 109–137, CMS Conf. Proc., 19, Amer. Math. Soc., Providence, RI, 1996.
- [PT99] J.A. de la Peña, M. Takane, *On the number of terms in the middle of almost split sequences over tame algebras*. Trans. Amer. Math. Soc. 351 (1999), no. 9, 3857–3868.
- [Rie80] C. Riedtmann, *Algebren, Darstellungsköcher, Überlagerungen und zurück*. (German) Comment. Math. Helv. 55 (1980), no. 2, 199–224.
- [R84] C.M. Ringel, *Tame algebras and integral quadratic forms*. Lecture Notes in Mathematics, 1099. Springer-Verlag, Berlin, 1984. xiii+376 pp.
- [R02] C.M. Ringel, *Combinatorial representation theory – History and future*. Representations of algebra. Vol. I, II, 122–144, Beijing Norm. Univ. Press, Beijing, 2002.
- [S94] A. Skowroński, *Generalized standard Auslander-Reiten components*. J. Math. Soc. Japan 46 (1994), no. 3, 517–543.
- [S96] A. Skowroński, *On omnipresent tubular families of modules*. Representation theory of algebras (Cocoyoc, 1994), 641–657, CMS Conf. Proc., 18, Amer. Math. Soc., Providence, RI, 1996.

- [SY11] A. Skowroński, K. Yamagata, *Frobenius algebras. I. Basic representation theory*. EMS Textbooks in Mathematics. European Mathematical Society (EMS), Zürich, 2011. xii+650 pp.
- [H90] H. von Höhne, *A new proof of the “4-terms in the middle”-theorem*. *Comm. Algebra* 18 (1990), no. 7, 2355–2360.
- [Z91] Y. Zhang, *The structure of stable components*. *Canad. J. Math.* 43 (1991), no. 3, 652–672.

14.10. Directing and reachable modules. As before, let A be a finite-dimensional K -algebra.

A **path** of length $n \geq 0$ in $\text{mod}(A)$ is a finite sequence

$$([X_0], [X_1], \dots, [X_n])$$

of isomorphism classes with $X_i \in \text{ind}(A)$ for all i such that $\text{rad}_A(X_{i-1}, X_i) \neq 0$ for $1 \leq i \leq n$.

Such a path $([X_0], [X_1], \dots, [X_n])$ **starts in** X_0 and **ends in** X_n . If $n \geq 1$ and $[X_0] = [X_n]$, then $([X_0], [X_1], \dots, [X_n])$ is a **cycle** in $\text{mod}(A)$. In this case, we say that the modules X_0, \dots, X_{n-1} **lie on a cycle**.

For $X, Y \in \text{ind}(A)$ we write $X \preceq Y$ if there exists a path which starts in X and ends in Y , and we write $X \prec Y$ if there is such a path of length $n \geq 1$.

$X \in \text{ind}(A)$ is **directing** if X does not lie on a cycle.

In other words, X is directing if and only if $X \not\prec X$.

Examples:

- (i) Let A be the path algebra of a Dynkin quiver. Then all indecomposable A -modules are directing.
- (ii) Let $A = K[T]/(T^m)$ for some $m \geq 2$. Then none of the indecomposable A -modules is directing.

Lemma 14.44. *Let X be a directing A -module, then $\text{End}_A(X)$ is a K -skew field, and we have $\text{Ext}_A^i(X, X) = 0$ for all $i \geq 1$.*

$X \in \text{mod}(A)$ is **sincere** if each simple A -module occurs as a composition factor of X .

Theorem 14.45. *Let X be a sincere directing A -module. Then the following hold:*

- (i) $\text{proj. dim}(X) \leq 1$;
- (ii) $\text{inj. dim}(X) \leq 1$;
- (iii) $\text{gl. dim}(A) \leq 2$.

Theorem 14.46. *Let $X, Y \in \text{ind}(A)$ with $\underline{\dim}(X) = \underline{\dim}(Y)$. If X is a directing module, then $X \cong Y$.*

$X \in \text{ind}(A)$ is **reachable** if there are only finitely many paths in $\text{mod}(A)$ which end in X .

Lemma 14.47. *Every reachable module is directing.*

Let $_{-1}\mathcal{P} := \emptyset$. For $n \geq 0$ let $_n\mathcal{P}$ be the class of all $X \in \text{ind}(A)$ such that all paths ending in X have length at most n . Let

$$_{\infty}\mathcal{P} := \bigcup_{n \geq 0} {}_n\mathcal{P}.$$

We get a chain

$$\emptyset = {}_{-1}\mathcal{P} \subseteq {}_0\mathcal{P} \subseteq \cdots \subseteq {}_{n-1}\mathcal{P} \subseteq {}_n\mathcal{P} \subseteq \cdots$$

Lemma 14.48. *For $X \in \text{ind}(A)$ the following are equivalent:*

- (i) X is reachable.
- (ii) $X \in {}_{\infty}\mathcal{P}$.

The following properties of $_{\infty}\mathcal{P}$ are easy to prove:

- (i) ${}_0\mathcal{P}$ is the class of simple projective modules.
- (ii) ${}_1\mathcal{P}$ contains additionally all indecomposable projective modules P such that $\text{rad}(P)$ is semisimple and projective.
- (iii) ${}_2\mathcal{P}$ can contain non-projective modules (e.g. if A is the path algebra of a quiver of Dynkin type A_2).
- (iv) ${}_n\mathcal{P}$ is closed under indecomposable submodules.
- (v) If $X \in {}_n\mathcal{P}$ is non-projective, then $\tau_A(X) \in {}_{n-2}\mathcal{P}$.
- (vi) For each $X \in {}_n\mathcal{P}$ there is some indecomposable projective A -module P and some $m \geq 0$ such that

$$X \cong \tau_A^{-m}(P).$$

As before, let Γ_A be the Auslander-Reiten quiver of A .

Let ${}_{-1}\Gamma := \emptyset$. For $n \geq 0$, if ${}_{n-1}\Gamma$ is already defined, then ${}_n\Gamma$ is the set of all vertices $[X] \in \Gamma_A$ such that all direct predecessors of $[X]$ in Γ_A are in ${}_{n-1}\Gamma$. Set

$${}_{\infty}\Gamma := \bigcup_{n \geq 0} {}_n\Gamma.$$

We get a chain of inclusions

$$\emptyset = {}_{-1}\Gamma \subseteq {}_0\Gamma \subseteq \cdots \subseteq {}_{n-1}\Gamma \subseteq {}_n\Gamma \subseteq \cdots$$

We have $X \in {}_n\mathcal{P}$ if and only if $[X] \in {}_n\Gamma$.

For $[X] \in \Gamma_A$ we have $[X] \in {}_{\infty}\Gamma$ if and only if there are only finitely many paths in Γ_A ending in $[X]$.

For $n \geq -1$ let ${}_n\underline{\Gamma}$ be the full subquiver of Γ_A with vertices ${}_n\Gamma$. Set

$${}_{\infty}\underline{\Gamma} := \bigcup_{n \geq 0} {}_n\underline{\Gamma}.$$

14.11. Knitting algorithm. The results in this section are based on Theorems 14.21 and 14.22, Corollary 14.23 and Lemma 14.24.

Here is the basic idea of the knitting process: Let $X \in \text{ind}(A)$. Whenever the sink map ending in X is known, we can construct the source map starting in X . In

(Γ_A, d_A) the situation around the vertex $[X]$ looks like this:

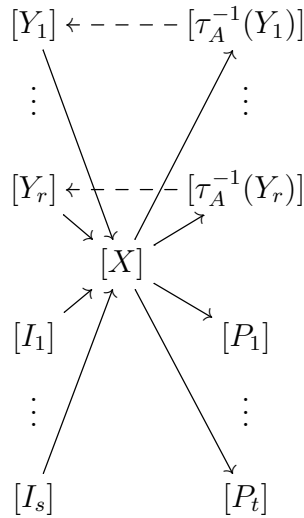

Here the Y_i are non-injective modules, the I_i are injective, and the P_i are projective. The sink map ending in X is of the form $Y \rightarrow X$ where

$$Y = \bigoplus_{i=1}^r Y_i^{d_{Y_i X}/d_{Y_i}} \oplus \bigoplus_{i=1}^s I_i^{d_{I_i X}/d_{I_i}}.$$

To get the source map $X \rightarrow Z$, we have to translate the non-injective modules Y_i using τ_A^{-1} . Note that

$$d_{X\tau_A^{-1}(Y_i)} = d_{Y_i X} \quad \text{and} \quad d_{\tau_A^{-1}(Y_i)} = d_{Y_i}$$

for all i . Furthermore, we have to check if X occurs as a direct summand of $\text{rad}(P)$ where P runs through the set of indecomposable projective modules.

For an indecomposable projective module P and an indecomposable module X let r_{XP} be the multiplicity of X in a direct sum decomposition of $\text{rad}(P)$ into indecomposables, i.e.

$$\text{rad}(P) = X^{r_{XP}} \oplus C$$

for some module C and r_{XP} is maximal with this property.

In this case, there is an arrow $[X] \rightarrow [P]$ with valuation

$$d_{XP} = r_{XP}d_X.$$

We get

$$Z = \bigoplus_{i=1}^r \tau_A^{-1}(Y_i)^{d_{X\tau_A^{-1}(Y_i)}/d_{\tau_A^{-1}(Y_i)}} \oplus \bigoplus_{i=1}^t P_i^{d_{XP_i}/d_{P_i}}.$$

If X is non-injective, we get a mesh

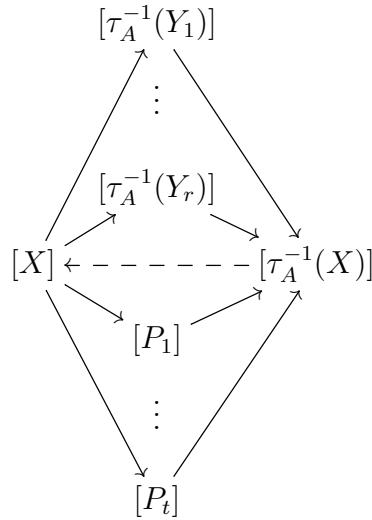

in the Auslander-Reiten quiver (Γ_A, d_A) . We have

$$d_{\tau_A^{-1}(Y_i)\tau_A^{-1}(X)} = d_{X\tau_A^{-1}(Y_i)} \quad \text{and} \quad d_{\tau_A^{-1}(X)} = d_X.$$

Knitting preparations:

- (i) Determine all indecomposable projectives $P(1), \dots, P(n)$ and all indecomposable injectives $I(1), \dots, I(n)$.
- (ii) For each $1 \leq i \leq n$ determine $\text{rad}(P(i))$ and decompose it into indecomposable modules, say

$$\text{rad}(P(i)) = \bigoplus_{j=1}^{r_i} R_{ij}^{r_{ij}}$$

where $r_{ij} \geq 1$, and the R_{ij} are indecomposable such that $R_{ik} \cong R_{il}$ if and only if $k = l$.

- (iii) For each $1 \leq i \leq n$ determine $d_{P(i)} = \dim_K F(P(i))$.

Since the inclusion $\text{rad}(P(i)) \rightarrow P(i)$ is a sink map, we have

$$d_{R_{ij}P(i)} = r_{ij}d_{R_{ij}} \quad \text{and} \quad r_{ij} = r_{R_{ij}P(i)}.$$

Furthermore, we know that

$$F(P(i)) = \text{End}_A(P(i))/\text{rad}(\text{End}_A(P(i))) \cong \text{End}_A(P(i)/\text{rad}(P(i))) \cong \text{End}_A(S(i))$$

where $S(i)$ is the simple A -module with $S(i) \cong P(i)/\text{rad}(P(i))$.

Knitting algorithm:

Let $_{-1}\underline{\Delta}$ be the empty quiver. For $n \geq 0$ we define inductively quivers ${}_n\underline{\Delta}$, ${}_n\underline{\Delta}(\text{proj})$, ${}_n\underline{\Delta}(\text{proj}, \tau^-)$, which are full valued translation subquivers of (Γ_A, d_A) .

- (In) **Define $n\Delta$:** Let $n\Delta$ be the full subquiver of ${}_{n-1}\Delta(\text{proj})$ with vertices $[X]$ such that all direct predecessors of $[X]$ in ${}_{n-1}\Delta(\text{proj})$ are contained in ${}_{n-1}\Delta$, and if $[X]$ is a vertex with $[X] = [P(i)]$ projective, then we require additionally that $[R_{ij}] \in {}_{n-1}\Delta$ for all j .
- (IIIn) **Add projectives:** For each $[X] \in n\Delta$, if $[X] = [R_{ij}]$ for some i, j , then (if it wasn't added already) add the vertex $[P(i)]$ to ${}_{n-1}\Delta(\text{proj}, \tau^-)$ with valuation $d_{P(i)}$, and add an arrow $[X] \rightarrow [P(i)]$ to ${}_{n-1}\Delta(\text{proj}, \tau^-)$ with valuation $d_{XP(i)} = r_{XP(i)}d_X$. We denote the resulting quiver by $n\Delta(\text{proj})$.
- (IIIIn) **Translate the non-injectives in $n\Delta \setminus {}_{n-1}\Delta$:** For each $[X] \in n\Delta \setminus {}_{n-1}\Delta$ with X non-injective, add the vertex $[\tau_A^{-1}(X)]$ to $n\Delta(\text{proj})$ with valuation $d_{\tau_A^{-1}(X)} = d_X$, and for each arrow $[X] \rightarrow [Y]$ constructed so far add an arrow $[Y] \rightarrow [\tau_A^{-1}(X)]$ to $n\Delta(\text{proj})$ with valuation $d_{Y\tau_A^{-1}(X)} = d_{XY}$. We denote the resulting quiver by $n\Delta(\text{proj}, \tau^-)$.

The algorithm stops if $n\Delta \setminus {}_{n-1}\Delta$ is empty for some n . It can happen that the algorithm never stops.

Define

$$\infty\Delta := \bigcup_{n \geq 0} n\Delta \quad \text{and} \quad \infty\Delta := \bigcup_{n \geq 0} n\Delta.$$

The situation around a vertex $[X] \in n\Delta$ looks like this:

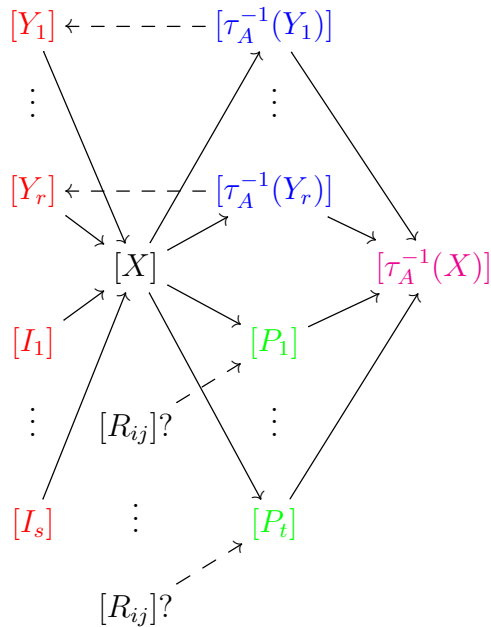

Red $\subseteq {}_{n-1}\Delta$, Blue $\subseteq {}_{n-1}\Delta(\text{proj}, \tau^-)$, Green $\subseteq n\Delta(\text{proj})$, Magenta $\subseteq n\Delta(\text{proj}, \tau^-)$. For each R_{ij} an indecomposable direct summand of $\text{rad}(P_k)$, one needs to check if $[R_{ij}] \in m\Delta$ for some m . Otherwise, $[P_k]$ will not be in $\infty\Delta$.

The following statements follow directly from the construction of ${}_{\infty}\underline{\Delta}$.

- (i) Let $[Y_i] \rightarrow [X]$, $1 \leq i \leq s$ be the arrows in ${}_n\underline{\Delta}$ ending in $[X]$. Then the sink map ending in X is of the form

$$\bigoplus_{i=1}^s Y_i^{d_{Y_i X}/d_{Y_i}} \rightarrow X$$

and $[Y_i] \in {}_{n-1}\underline{\Delta}$ for all i .

- (ii) Let $[X] \in {}_n\underline{\Delta}$, and let $[X] \rightarrow [Z_i]$, $1 \leq i \leq t$ be the arrows in ${}_n\underline{\Delta}(\text{proj})$ starting in $[X]$. Then the source map starting in X is of the form

$$X \rightarrow \bigoplus_{i=1}^t Z_i^{d_{X Z_i}/d_{Z_i}}.$$

- (iii) For $[X]$ and $[Z_i]$ as in (ii) the following are equivalent:

- (a) X is non-injective.
 (b) We have

$$l(X) < \sum_{i=1}^t d_{X Z_i}/d_{Z_i} \cdot l(Z_i).$$

In this case, we have

$$\underline{\dim}(\tau_A^{-1}(X)) = -\underline{\dim}(X) + \sum_{i=1}^t d_{X Z_i}/d_{Z_i} \cdot \underline{\dim}(Z_i).$$

Lemma 14.49. *For all $n \geq -1$ we have*

$${}_n\underline{\Delta} = {}_n\underline{\Gamma}.$$

In particular, ${}_{\infty}\underline{\Delta} = {}_{\infty}\underline{\Gamma}$.

Corollary 14.50. *Let $[X] \in {}_{\infty}\underline{\Delta}$ and $[Y] \in \Gamma_A$. Then $[X] = [Y]$ if and only if $\underline{\dim}(X) = \underline{\dim}(Y)$.*

If we know the dimension vectors $\underline{\dim}(P(i))$ and $\underline{\dim}(R_{ij})$ for all i, j , then our knitting algorithm yields an algorithm to determine $\underline{\dim}(X)$ for any vertex $[X] \in {}_{\infty}\underline{\Delta}$. We get a knitting algorithm which only uses dimension vectors.

Here are some further remarks:

- (i) We have ${}_{\infty}\underline{\Delta} \neq \emptyset$ if and only if there is a simple projective module.
 (ii) The number of connected components of ${}_{\infty}\underline{\Delta}$ is bounded by the number of simple projective A -modules.
 (iii) For each $[X] \in {}_{\infty}\underline{\Delta}$ we have $X \cong \tau_A^{-m}(P)$ for some indecomposable projective P and some $m \geq 0$.

- (iv) There is also a dual knitting algorithm by starting with the simple injective A -modules. As a knitting preparation one needs to decompose $I(i)/\text{soc}(I(i))$ into a direct sum of indecomposables, and one needs the values $d_{I(i)}$.

Lemma 14.51. *Let \mathcal{C} be a connected component of Γ_A . Then the following are equivalent:*

- (i) \mathcal{C} is a preprojective component of Γ_A .
- (ii) $\mathcal{C} \subseteq \infty\Delta$.

Recall that

$$\infty\Gamma = \infty\Delta, \quad \text{and} \quad \infty\mathcal{P} = \{X \in \text{ind}(A) \mid [X] \in \infty\Gamma\}$$

where $\infty\mathcal{P}$ is the class of reachable A -modules. We consider $\infty\mathcal{P}$ as a full subcategory of $\text{mod}(A)$.

Theorem 14.52. *For a finite-dimensional K -algebra A the following are equivalent:*

- (i) A is a directed algebra.
- (ii) $\infty\mathcal{P} = \text{ind}(A)$.
- (iii) $\infty\Delta = \Gamma_A$.
- (iv) Γ_A is a union of preprojective components.
- (v) Γ_A is a union of preinjective components.

In this case, A is representation-finite.

Using covering theory and knitting, one can also construct the Auslander-Reiten quiver of most non-directed representation-finite algebras.

Proposition 14.53. *Let A be a finite-dimensional connected hereditary algebra. Then the following hold:*

- (i) Γ_A has a unique preprojective component $\Gamma_{\mathcal{P}}$ and a unique preinjective component $\Gamma_{\mathcal{I}}$.
- (ii) $\Gamma_{\mathcal{P}} = \infty\Delta$.
- (iii) $\Gamma_{\mathcal{P}} = \Gamma_{\mathcal{I}}$ if and only if A is representation-finite.

14.12. Examples (knitting). If not mentioned otherwise, all vertices in the following examples have valuation 1.

14.12.1. Let Q be the quiver

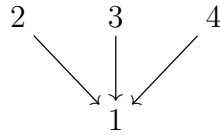

and let $A = KQ$. Using the dimension vector notation, Γ_A looks as follows:

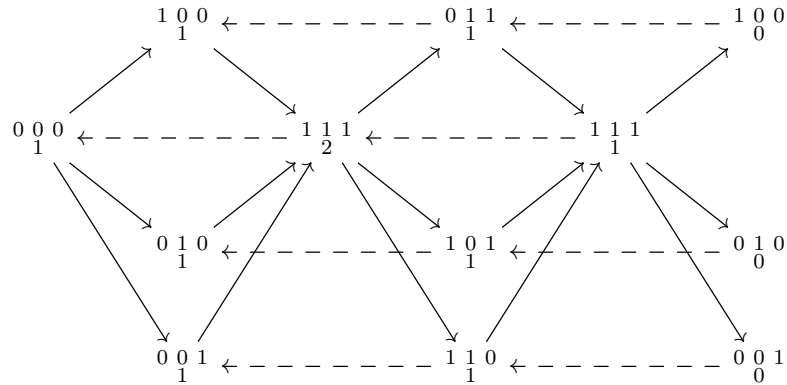

14.12.2. Here is the Auslander-Reiten quiver of the algebra $A = KQ/I$ where Q is the quiver

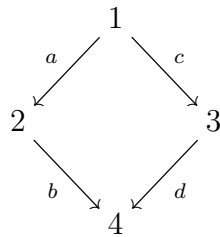

and I is the ideal generated by $ba - dc$:

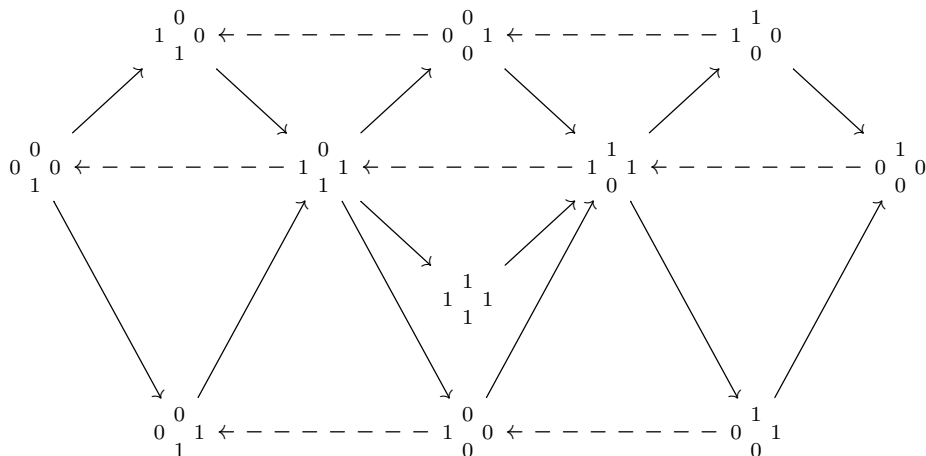

14.12.3. Let Q be the quiver

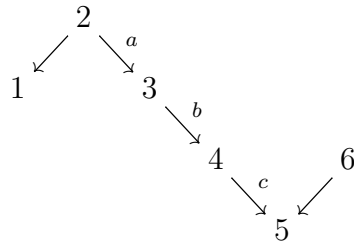

and let $A = KQ/I$ where I is generated by cba . In the following two pictures we display the composition factors of the indecomposable modules. (When the submodule lattice of a module is not too complicated, this can be a good alternative to displaying dimension vectors.) The number i stands for the simple module $S(i)$. Then Γ_A looks as follows:

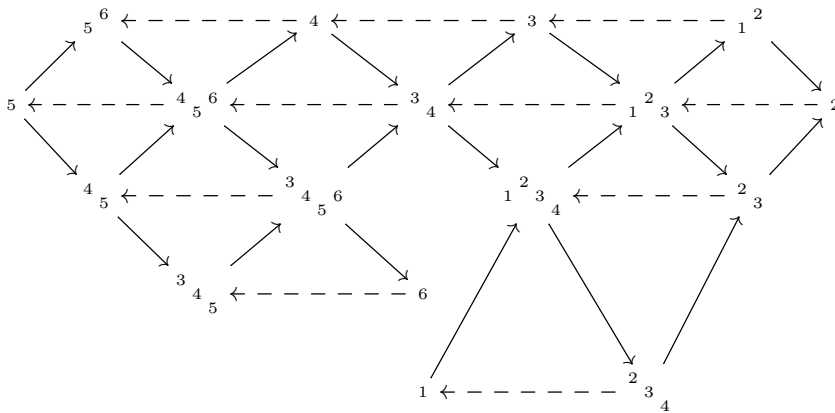

14.12.4. Let $A = KQ/I$ where Q is the quiver

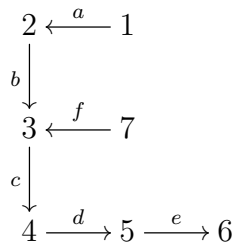

and the ideal I is generated by $edcba$ and dcf . Here is Γ_A :

14.12.5. Let A be the path algebra of the quiver

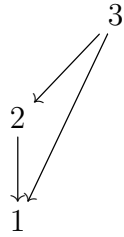

Then there is an infinite preprojective component in Γ_A , which can be obtained from the following picture by identifying the vertices in the first with the corresponding vertices in the fourth row:

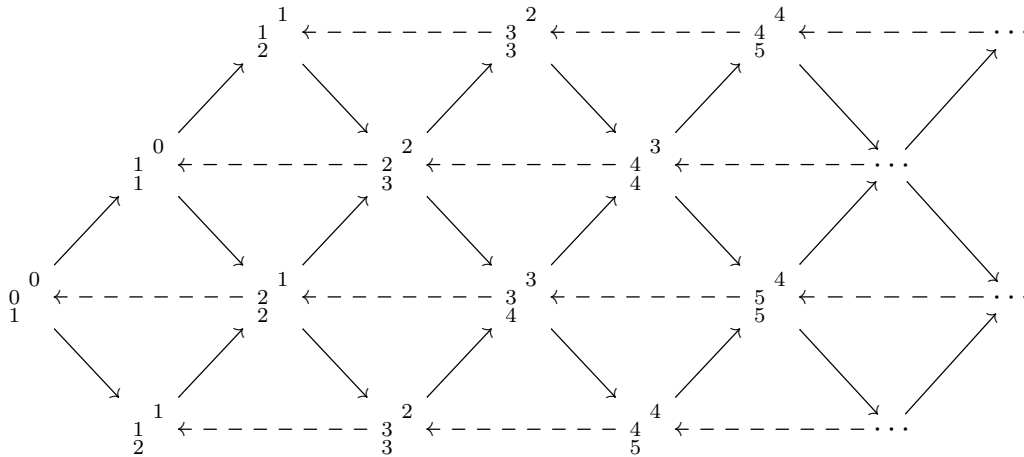

14.12.6. Let $A = KQ/I$ where Q is the quiver

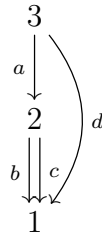

and I is the ideal generated by ba . The indecomposable projective A -modules are of the form

$$P(1) = \begin{matrix} 1 \\ \hline 1 \end{matrix}, \quad P(2) = \begin{matrix} 2 \\ \hline 1 \end{matrix} \begin{matrix} 1 \\ \hline 1 \end{matrix}, \quad P(3) = \begin{matrix} 3 \\ \hline 2 \end{matrix} \begin{matrix} 1 \\ \hline 1 \end{matrix}.$$

We have $d_{P(i)} = 1$ for all i . Then ${}_{\infty}\underline{\Delta}$ consists of two points, namely $P(1)$ and $P(2)$:

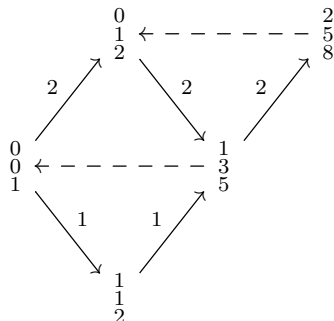

We have

$$\text{rad}(P(1)) = 0 \quad \text{and} \quad \text{rad}(P(2)) = \begin{pmatrix} \mathbb{C} \\ 0 \end{pmatrix} = \begin{pmatrix} \mathbb{R} \\ 0 \end{pmatrix} \oplus \begin{pmatrix} \mathbb{R} \\ 0 \end{pmatrix} = P(1) \oplus P(1)$$

and $F(P(i)) \cong \mathbb{R}$ for $i = 1, 2$. This implies

$$d_{P(1)P(2)} = r_{P(1)P(2)}d_{P(1)} = 2 \cdot 1.$$

Knitting gives an infinite preprojective component of Γ_A :

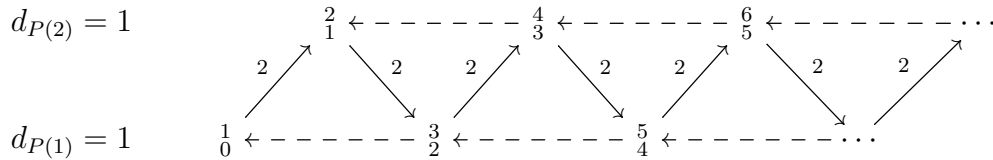

14.12.9. In the previous two examples, we could have worked with a field extension $K \subset L$ with $\dim_K(L) = 2$ instead of the field extension $\mathbb{R} \subset \mathbb{C}$. Essentially this would lead to the same results. Note however the following: For

$$A = \begin{pmatrix} \mathbb{Q} & \mathbb{Q}(\sqrt{2}) \\ 0 & \mathbb{Q}(\sqrt{2}) \end{pmatrix} \quad \text{and} \quad B = \begin{pmatrix} \mathbb{Q} & \mathbb{Q}(\sqrt{3}) \\ 0 & \mathbb{Q}(\sqrt{3}) \end{pmatrix}.$$

the Auslander-Reiten quivers Γ_A and Γ_B are isomorphic as valued translation quivers, but A and B are not isomorphic, and also not Morita equivalent.

14.12.10. Let

$$A = \begin{pmatrix} K & L \\ 0 & L \end{pmatrix} \subset M_2(L)$$

where $K \subset L$ is a field extension of dimension 3, e.g. $K = \mathbb{Q}$ and $L = \mathbb{Q}(\sqrt[3]{2})$. The indecomposable projective A -modules are

$$P(1) = \begin{pmatrix} K \\ 0 \end{pmatrix} \quad \text{and} \quad P(2) = \begin{pmatrix} L \\ L \end{pmatrix}.$$

In this case there are 6 indecomposable A -modules, and Γ_A looks like this:

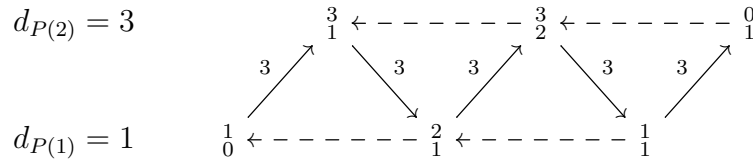

14.12.11. Let

$$A = \begin{pmatrix} K & L \\ 0 & L \end{pmatrix} \subset M_2(L)$$

where $K \subset L$ is a field extension of dimension 4. The indecomposable projective A -modules are

$$P(1) = \begin{pmatrix} K \\ 0 \end{pmatrix} \quad \text{and} \quad P(2) = \begin{pmatrix} L \\ L \end{pmatrix}.$$

Then Γ_A has an infinite preprojective component:

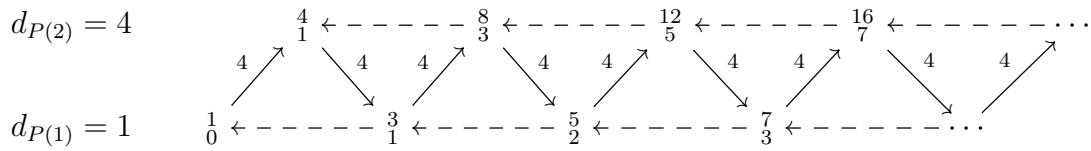

14.13. **Mesh category.** Let A be a finite-dimensional K -algebra.

We say that K is a **splitting field** for A if

$$\text{End}_A(S) \cong K$$

for all simple A -modules S .

Examples:

- (i) If K is algebraically closed, then K is a splitting field for every A .
- (ii) If $A = KQ/I$ is a basic algebra, then K is a splitting field for A .

Lemma 14.54. *Assume that K is a splitting field for A . Then $\text{End}_A(X) \cong K$ for all $X \in \infty\mathcal{P}$. In particular, the valuation for $\infty\Gamma$ splits.*

Recall that the mesh category of a translation quiver Γ is denoted by $K\langle\Gamma\rangle$.

Theorem 14.55. *Assume that K is a splitting field for A . Then there is an equivalence of categories*

$$K\langle\Gamma\rangle \rightarrow \infty\mathcal{P}$$

where $\Gamma := (\infty\Gamma)^e$ is the expansion of the valued translation quiver $\infty\Gamma$.

Let $M, X \in \text{ind}(A)$ be non-isomorphic such that X is non-projective. Let

$$0 \rightarrow \tau_A(X) \rightarrow E \rightarrow X \rightarrow 0$$

be the Auslander-Reiten sequence ending in X . Then

$$0 \rightarrow \text{Hom}_A(M, \tau_A(X)) \rightarrow \text{Hom}_A(M, E) \rightarrow \text{Hom}_A(M, X) \rightarrow 0$$

is exact.

Let $\Gamma = (\infty\Gamma)^e$. If $[X]$ and $[Z]$ are vertices in Γ such that none of the paths in Γ starting in $[X]$ and ending in $[Z]$ contains a subpath of the form $[Y] \rightarrow [N] \rightarrow [\tau_A^{-1}(Y)]$ for some vertices $[Y]$ and $[N]$ of Γ , then we have

$$\text{Hom}_{K\langle\Gamma\rangle}([X], [Z]) = \text{Hom}_{K\Gamma}([X], [Z]).$$

Using these two facts one can calculate dimensions of homomorphism spaces in the mesh category $K\langle\Gamma\rangle$. This is illustrated in the examples below.

14.14. Examples (mesh categories).

14.14.1. Let Q be the quiver

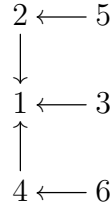

and let $A = KQ$. Here is Γ_A :

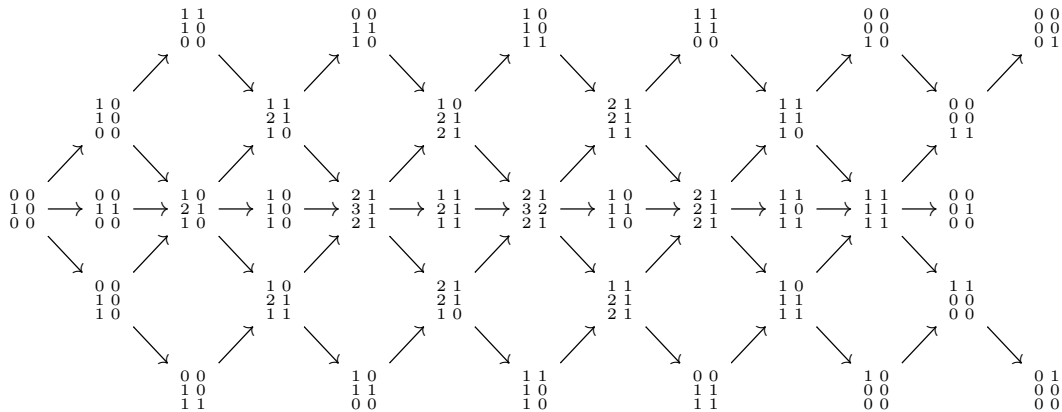

The next diagram shows the locations of the indecomposable projective and the indecomposable injective A -modules:

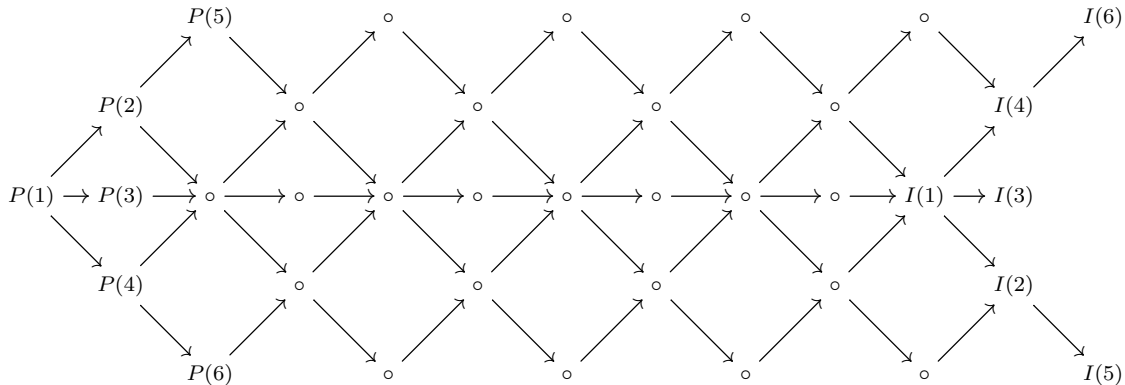

The following pictures show how to compute $\dim \text{Hom}_A(P(i), -)$ for all indecomposable projective A -modules $P(i)$. Note that the cases $P(2)$ and $P(4)$, and also $P(5)$ and $P(6)$ are dual to each other. We marked the vertices $[Z]$ by \boxed{a} where $a = \dim \text{Hom}_A(P(i), Z)$, provided none of the paths in Γ_A starting in $[P(i)]$ and ending in $[Z]$ contains a subpath of the form $[Y] \rightarrow [E] \rightarrow [\tau_A^{-1}(Y)]$. One can compute $\dim \text{Hom}_A(X, -)$ for all $X \in \text{ind}(A)$ in a similar fashion.

$\dim \text{Hom}_A(P(1), -)$:

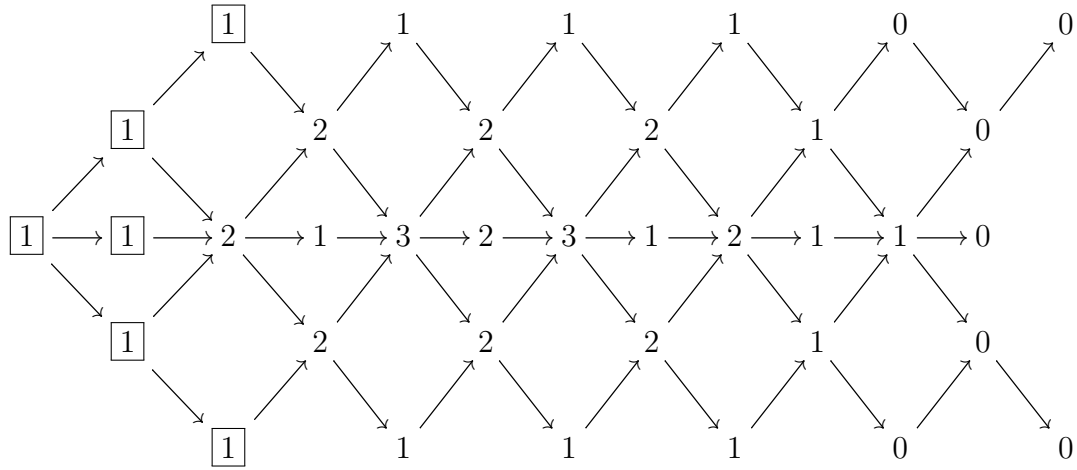

$\dim \text{Hom}_A(P(2), -)$:

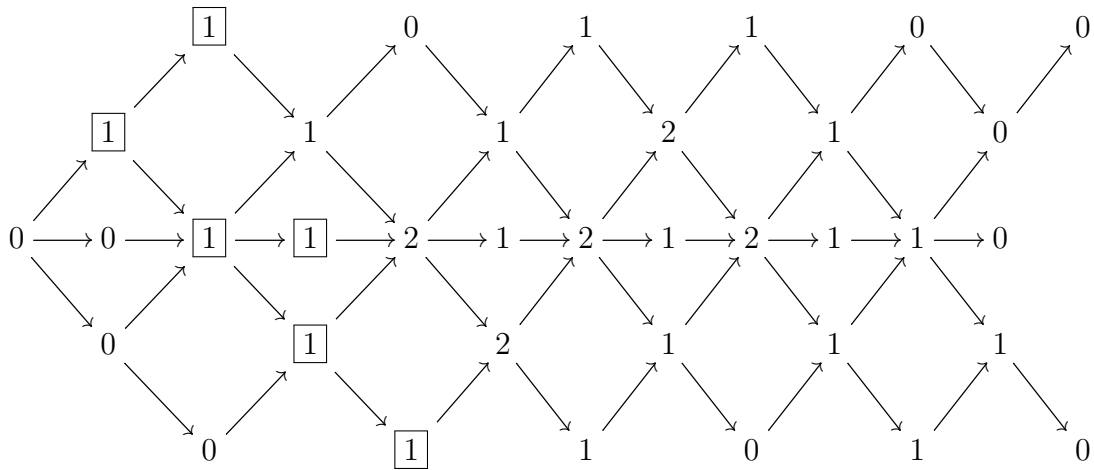

$\dim \text{Hom}_A(P(3), -)$:

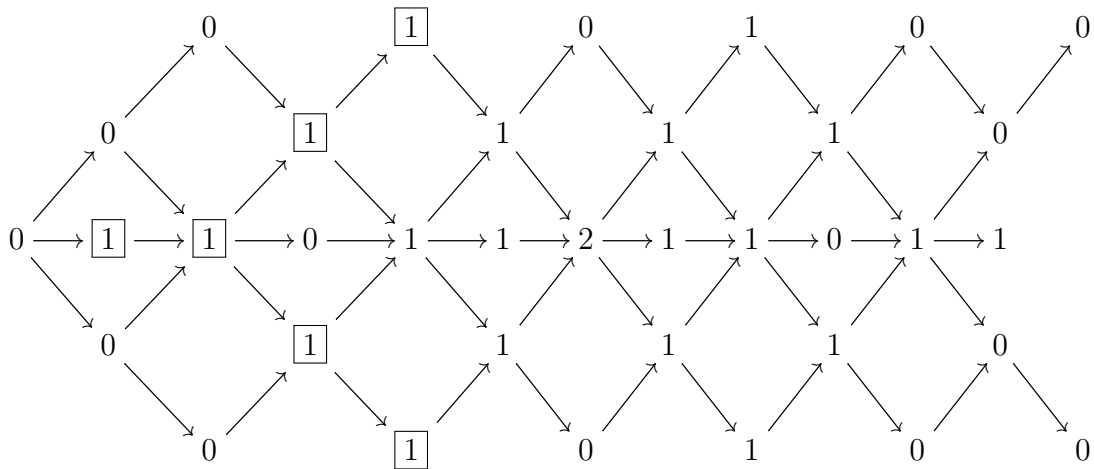

$\dim \text{Hom}_A(P(5), -)$:

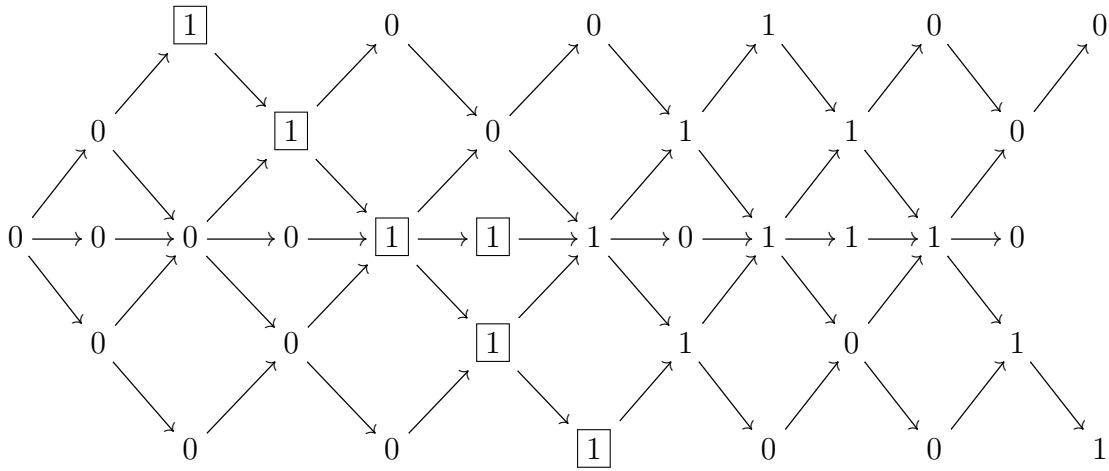

14.14.2. The preprojective component of the Kronecker quiver

$$1 \rightleftarrows 2$$

looks as follows:

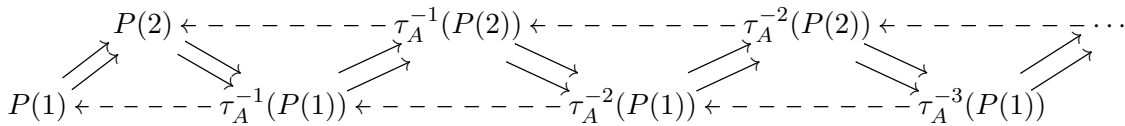

A straightforward computation in the mesh category yields for example

$$\dim \text{Hom}_A(\tau_A^{-1}(P(1)), \tau_A^{-2}(P(2))) = 4.$$

14.14.3. Let $A = K[X, Y]/(X^2, Y^2, XY)$. There is just one simple A -module S . Let P be its projective cover and I its injective envelope. The modules P and $\tau_A^{-1}(S)$ look as follows:

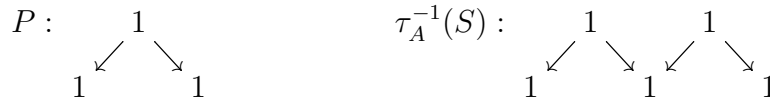

The Auslander-Reiten component Γ containing these modules looks as follows:

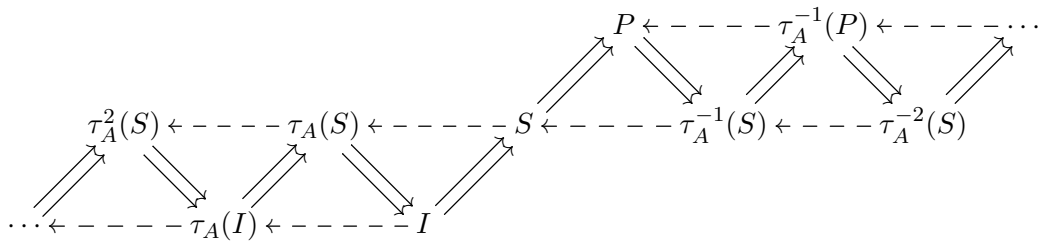

In the mesh category of Γ we have

$$\text{Hom}_{K\langle\Gamma\rangle}([P], [\tau_A^{-1}(S)]) = 2 \quad \text{and} \quad \text{Hom}_{K\langle\Gamma\rangle}([\tau_A^{-1}(S)], [P]) = 0.$$

However, it is easy to check that

$$\dim \operatorname{Hom}_A(P, \tau_A^{-1}(S)) = 5 \quad \text{and} \quad \dim \operatorname{Hom}_A(\tau_A^{-1}(S), P) = 4.$$

15. Varieties of modules and algebras

Let K be algebraically closed, and let A be a finite-dimensional K -algebra.

15.1. Varieties of modules.

For $d \geq 0$ let $\text{mod}(A, d)$ be the set of all K -algebra homomorphisms

$$A \rightarrow M_d(K).$$

Then $\text{mod}(A, d)$ is an affine variety. Its elements can also be seen as the closed points of an affine scheme $\mathbf{mod}(A, d)$ which is defined in the obvious way.

Each $M \in \text{mod}(A, d)$ gives rise to an d -dimensional A -module, and up to isomorphism each d -dimensional A -module occurs in this way. Therefore, one calls $\text{mod}(A, d)$ (resp. $\mathbf{mod}(A, d)$) the **variety of d -dimensional A -modules** (resp. **scheme of d -dimensional A -modules**).

In general, the varieties $\text{mod}(A, d)$ are singular and have many irreducible components.+

Theorem 15.1 (Bongartz [B91, Proposition 1]). *The following are equivalent:*

- (i) $\mathbf{mod}(A, d)$ is smooth for all $d \geq 0$;
- (ii) A is hereditary.

Let

$$\text{ind}(A, d) := \{M \in \text{mod}(A, d) \mid M \text{ is indecomposable}\}.$$

Then $\text{ind}(A, d)$ is a constructible subset of $\text{mod}(A, d)$.

The group $\text{GL}_d(K)$ acts by conjugation on $\text{mod}(A, d)$: For $g \in \text{GL}_d(K)$ and $M \in \text{mod}(A, d)$ define

$$\begin{aligned} g.M &: A \rightarrow M_d(K) \\ a &\mapsto gM(a)g^{-1}. \end{aligned}$$

The **orbit** of $M \in \text{mod}(A, d)$ is

$$\mathcal{O}_M := \{g.M \mid g \in \text{GL}_d(K)\}.$$

Then \mathcal{O}_M is a locally closed subset of $\text{mod}(A, d)$.

Let \mathcal{O}_M also denote the corresponding orbit in $\mathbf{mod}(A, d)$.

Lemma 15.2. *For $M, N \in \text{mod}(A, d)$ the following are equivalent:*

- (i) $\mathcal{O}_M = \mathcal{O}_N$;
- (ii) $M \cong N$.

Often the dimension of an orbit can be calculated with the help of the following lemma.

Proposition 15.3. *For $M \in \text{mod}(A, d)$ we have*

$$\dim \mathcal{O}_M = d^2 - \dim \text{End}_A(M).$$

For any constructible subset U of an affine variety X , we denote the Zariski closure of U by \overline{U} .

For $M, N \in \text{mod}(A, d)$ we write $M \leq_{\text{deg}} N$ if

$$N \in \overline{\mathcal{O}_M}.$$

In this case we say that N is a **degeneration** of M .

Short exact sequences provide a large source of examples of degenerations, but not all degenerations occur in this way.

Proposition 15.4. *For each short exact sequence*

$$0 \rightarrow N \rightarrow M \rightarrow N' \rightarrow 0$$

in $\text{mod}(A)$ we have $M \leq_{\text{deg}} N \oplus N'$.

Theorem 15.5 (Zwara [Z00]). *For $M, N \in \text{mod}(A, d)$ the following are equivalent:*

- (i) $M \leq_{\text{deg}} N$;
- (ii) *There exists some $Z \in \text{mod}(A)$ and a short exact exact sequence*

$$0 \rightarrow Z \rightarrow Z \oplus M \rightarrow N \rightarrow 0;$$

- (iii) *There exists some $Z \in \text{mod}(A)$ and a short exact exact sequence*

$$0 \rightarrow N \rightarrow M \oplus Z \rightarrow Z \rightarrow 0.$$

The directions (ii) \implies (i) and (iii) \implies (i) are due to Riedtmann [R86, Proposition 3.4]. Short exact sequences like in (ii) and (iii) are called **Riedtmann sequences**.

For $M, N \in \text{mod}(A, d)$ we write $M \leq_{\text{virt}} N$ if there exists some $Z \in \text{mod}(A)$ such that

$$M \oplus Z \leq_{\text{deg}} N \oplus Z.$$

This notion of a **virtual degeneration** is due to Riedtmann [R86].

The existence of a degeneration $M \oplus Z \leq_{\text{deg}} N \oplus Z$ usually does not imply that $M \leq_{\text{deg}} N$. This runs under the label *failure of cancellation*.

For M, N we write $M \leq_{\text{hom}} N$ if

$$\dim \text{Hom}_A(M, X) \leq \dim \text{Hom}_A(N, X)$$

for all $X \in \text{mod}(A)$.

It can be shown that $M \leq_{\text{hom}} N$ if and only if

$$\dim \text{Hom}_A(X, M) \leq \dim \text{Hom}_A(X, N)$$

for all $X \in \text{mod}(A)$.

For $M, N \in \text{mod}(A, d)$ we write $M \leq_{\text{ext}} N$ if there exist short exact sequences

$$0 \rightarrow N_i \rightarrow M_i \rightarrow N'_i \rightarrow 0$$

with $1 \leq i \leq s$ such that $M_i \cong N_{i-1} \oplus N'_{i-1}$ for $2 \leq i \leq s$, $M = M_1$ and $N = N_s \oplus N'_s$.

Proposition 15.6. $\leq_{\text{ext}}, \leq_{\text{deg}}, \leq_{\text{virt}}$ and \leq_{hom} define partial orders on the set of isomorphism classes of d -dimensional A -modules.

Proposition 15.7. For $M, N \in \text{mod}(A, d)$ we have

$$M \leq_{\text{ext}} N \implies M \leq_{\text{deg}} N \implies M \leq_{\text{virt}} N \implies M \leq_{\text{hom}} N.$$

The following two examples are due to John Carlson.

(i) Let $A = KQ/I$ where Q is the quiver

$$a \begin{array}{c} \curvearrowright \\ 1 \longleftarrow 2 \end{array}$$

and I is generated by a^2 . We define three A -modules as follows:

$$M: \begin{array}{c} 2 \\ \downarrow \\ 1 \\ \downarrow \\ 1 \end{array} \quad N: \begin{array}{ccc} 2 & & 1 \\ & \searrow & \swarrow \\ & 1 & \end{array} \quad Z: \begin{array}{c} 1 \\ \downarrow \\ 1 \end{array}$$

There is a short exact sequence

$$0 \rightarrow Z \rightarrow Z \oplus M \rightarrow N \rightarrow 0.$$

Thus $M \leq_{\text{deg}} N$. Since M and N are indecomposable and not isomorphic, we get $M \not\leq_{\text{ext}} N$.

(ii) Let $A = KQ/I$ where Q is the quiver

$$a \begin{array}{c} \curvearrowright \\ \curvearrowleft \end{array} 1 \begin{array}{c} \curvearrowleft \\ \curvearrowright \end{array} b$$

and I is generated by $\{a^2, b^2, ab-ba\}$. Let $P = {}_A A$. Thus P looks as follows:

$$\begin{array}{ccc} & 1 & \\ a \swarrow & & \searrow b \\ 1 & & 1 \\ b \searrow & & \swarrow a \\ & 1 & \end{array}$$

For $\lambda \in K$ let $M_\lambda: A \rightarrow M_2(K)$ be the A -module defined by

$$M_\lambda(a) = \begin{pmatrix} 0 & 0 \\ 1 & 0 \end{pmatrix} \quad \text{and} \quad M_\lambda(b) = \begin{pmatrix} 0 & 0 \\ \lambda & 0 \end{pmatrix}.$$

Finally, let S be the simple A -module. There are short exact sequences

$$\begin{aligned} 0 &\rightarrow \text{rad}(P) \rightarrow P \oplus \text{rad}(P)/\text{soc}(P) \rightarrow P/\text{soc}(P) \rightarrow 0 \\ 0 &\rightarrow M_\lambda \rightarrow \text{rad}(P) \rightarrow S \rightarrow 0 \\ 0 &\rightarrow S \rightarrow P/\text{soc}(P) \rightarrow M_\mu \rightarrow 0 \end{aligned}$$

where $\lambda, \mu \in K$. Note that $\text{rad}(P)/\text{soc}(P) \cong S^2$. We get degenerations

$$P \oplus S^2 \leq_{\text{deg}} \text{rad}(P) \oplus P/\text{soc}(P) \leq_{\text{deg}} M_\lambda \oplus M_\mu \oplus S^2.$$

Thus we have $P \leq_{\text{virt}} M_\lambda \oplus M_\mu$ for all $\lambda, \mu \in K$. A straightforward dimension argument shows that $P \not\leq_{\text{deg}} M_\lambda \oplus M_\mu$, see [R86, Section 3.1].

Question 15.8 (Bongartz [B96, Section 1]). *Do \leq_{virt} and \leq_{hom} coincide?*

Theorem 15.9 (Bongartz [B96, Corollary 4.2]). *Let A be a directed algebra. Then for $M, N \in \text{mod}(A, d)$ we have*

$$M \leq_{\text{ext}} N \iff M \leq_{\text{deg}} N \iff M \leq_{\text{virt}} N \iff M \leq_{\text{hom}} N.$$

Theorem 15.10 (Riedtmann [R86, Corollary 2.3], Zwara [Z99, Theorem 1]). *Let A be a representation-finite algebra. Then for $M, N \in \text{mod}(A, d)$ we have*

$$M \leq_{\text{deg}} N \iff M \leq_{\text{virt}} N \iff M \leq_{\text{hom}} N.$$

For $M \in \text{mod}(A, d)$ let T_M (resp. \mathbf{T}_M) be the tangent space of $\text{mod}(A, d)$ (resp. $\mathbf{mod}(A, d)$) at M , and let T_M° be the tangent space of \mathcal{O}_M at M . We have $\dim T_M^\circ = \dim \mathcal{O}_M$.

The following result is often useful and helps to calculate $\dim T_M$ or $\dim \mathbf{T}_M$ in many situations.

Theorem 15.11 (Voigt's Lemma [G74, Proposition 1.1]). *For $M \in \text{mod}(A, d)$ there is an injective map*

$$T_M/T_M^\circ \rightarrow \text{Ext}_A^1(M, M)$$

and an isomorphism

$$\mathbf{T}_M/T_M^\circ \rightarrow \text{Ext}_A^1(M, M).$$

Corollary 15.12 ([G74, Corollary 2.2]). *For $M \in \text{mod}(A, d)$ the following are equivalent:*

- (i) \mathcal{O}_M is an open subscheme of $\mathbf{mod}(A, d)$;
- (ii) $\text{Ext}_A^1(M, M) = 0$.

Corollary 15.13. *Let $M \in \text{mod}(A, d)$. If $\text{Ext}_A^1(M, M) = 0$, then \mathcal{O}_M is open in $\text{mod}(A, d)$.*

The converse of the previous corollary is in general wrong. There is an example in Section 15.2.

Lemma 15.14 ([G74, Corollary 1.3]). *For $M \in \text{mod}(A, d)$ the following are equivalent:*

- (i) \mathcal{O}_M is closed;
- (ii) M is semisimple.

Recall that the **dimension vector** of $M \in \text{mod}(A)$ is defined as $\underline{\dim}(M) = ([M : S])_S$ where S runs over all isomorphism classes of simple A -modules, and $[M : S]$ denotes the Jordan-Hölder multiplicity of S in M .

Proposition 15.15 ([G74, Corollary 1.4]). *The following hold:*

- (i) *Each connected component of $\text{mod}(A, d)$ contains exactly one closed orbit.*
- (ii) *For $M, N \in \text{mod}(A, d)$ the following are equivalent:*
 - (a) *M and N belong to the same connected component of $\text{mod}(A, d)$;*
 - (b) $\underline{\dim}(M) = \underline{\dim}(N)$.

15.2. Direct sums of irreducible components. Let $\text{Irr}(A, d)$ be the set of irreducible components of $\text{mod}(A, d)$, and let

$$\text{Irr}(A) = \bigcup_{d \geq 0} \text{Irr}(A, d).$$

For $Z \in \text{Irr}(A)$ and $M \in Z$ let $\underline{\dim}(Z) := \underline{\dim}(M)$ be the **dimension vector** of Z . For a simple A -module S let $[Z : S] := [M : S]$.

These definitions do not depend on the choice of M .

The following is a direct consequence of Proposition 15.15.

Proposition 15.16. *For $Z_1, Z_2 \in \text{Irr}(A, d)$ the following are equivalent:*

- (i) $\underline{\dim}(Z_1) = \underline{\dim}(Z_2)$;
- (ii) Z_1 and Z_2 belong to the same connected component of $\text{mod}(A, d)$.

Proposition 15.17. *For $M \in \text{mod}(A, d)$ the following are equivalent:*

- (i) \mathcal{O}_M is open in $\text{mod}(A, d)$;
- (ii) $\overline{\mathcal{O}_M} \in \text{Irr}(A, d)$.

Let $d_1, \dots, d_t, d \in \mathbb{N}$ with $d = d_1 + \dots + d_t$, and let $Z_i \in \text{Irr}(A, d_i)$ for $1 \leq i \leq t$. Then

$$\begin{aligned} \text{GL}_d(K) \times Z_1 \times \dots \times Z_t &\rightarrow \text{mod}(A, d) \\ (g, M_1, \dots, M_t) &\mapsto g \cdot (M_1 \oplus \dots \oplus M_t) \end{aligned}$$

is a morphism of affine varieties. We denote its image by

$$Z_1 \oplus \dots \oplus Z_t.$$

For $Z \in \text{Irr}(A)$ and $n \geq 1$ let $Z^n := Z \oplus \dots \oplus Z$ be the direct sum of n copies of Z .

The Zariski closure

$$\overline{Z_1 \oplus \dots \oplus Z_t}$$

is an irreducible closed subset of $\text{mod}(A, d)$.

However, in general we have $\overline{Z_1 \oplus \dots \oplus Z_t} \notin \text{Irr}(A, d)$.

For $Z_1, Z_2 \in \text{Irr}(A)$ define

$$e(Z_1, Z_2) := \min\{\dim \text{Ext}_A^1(M_1, M_2) \mid (M_1, M_2) \in Z_1 \times Z_2\}.$$

By upper semicontinuity the set

$$\{(M_1, M_2) \in Z_1 \times Z_2 \mid \dim \text{Ext}_A^1(M_1, M_2) = e(Z_1, Z_2)\}$$

is a dense open subset of $Z_1 \times Z_2$.

Theorem 15.18 (Crawley-Boevey, Schröer [CBS02]). *For $Z_1, \dots, Z_t \in \text{Irr}(A)$ the following are equivalent:*

- (i) $\overline{Z_1 \oplus \dots \oplus Z_t} \in \text{Irr}(A)$;
- (ii) $e(Z_i, Z_j) = 0$ for all $i \neq j$.

$Z \in \text{Irr}(A)$ is **indecomposable** if the indecomposable modules in Z form a dense subset of Z .

Examples:

- (i) Let $A = K[X]/(X^2)$ and $d = 1$. Then $\text{mod}(A, d)$ consists just of a point which corresponds to the simple A -module S . Thus $Z := \mathcal{O}_S = \overline{\mathcal{O}_S} = \text{mod}(A, 1)$ is an indecomposable irreducible component. We have $e(Z, Z) = 1$, since $\dim \text{Ext}_A^1(S, S) = 1$. In particular, we get $\overline{Z \oplus Z} \notin \text{Irr}(A, 2)$.
- (ii) Let $M \in \text{mod}(A, d)$ with $\text{Ext}_A^1(M, M) = 0$, and let $Z := \overline{\mathcal{O}_M}$. Then $\overline{Z^n} \in \text{mod}(A, nd)$ for all $n \geq 1$.
- (iii) Let $A = KQ$ where Q is the Kronecker quiver

$$1 \begin{array}{c} \xleftarrow{a} \\ \xrightarrow{b} \end{array} 2$$

For $\lambda \in K$ let $M_\lambda \in \text{mod}(A, 2)$ be the A -module defined by

$$K \begin{array}{c} \xleftarrow{(1)} \\ \xrightarrow{(\lambda)} \end{array} K$$

Then

$$Z := \overline{\bigcup_{\lambda \in K} \mathcal{O}_{M_\lambda}} \in \text{Irr}(A, 2).$$

Since $e(Z, Z) = 0$, we get that $Z' := \overline{Z \oplus Z} \in \text{Irr}(A, 4)$. Thus Z' is not indecomposable. However, Z' contains the indecomposable A -modules defined

by

$$K^2 \begin{array}{c} \left(\begin{array}{cc} 1 & 0 \\ 0 & 1 \end{array} \right) \\ \xleftrightarrow{\quad} \\ \left(\begin{array}{cc} \lambda & 1 \\ 0 & \lambda \end{array} \right) \end{array} K^2$$

for $\lambda \in K$.

The following result is a Krull-Remak-Schmidt Theorem for irreducible components.

Theorem 15.19. *For $Z \in \text{Irr}(A)$ there exist uniquely determined indecomposable irreducible components $Z_1, \dots, Z_t \in \text{Irr}(A)$ such that*

$$Z = \overline{Z_1 \oplus \dots \oplus Z_t}.$$

Theorem 15.19 can be deduced from the considerations in [P91a, Section 1.3]. A detailed proof can be found in [CBS02, Section 2].

In the situation of Theorem 15.19 we call

$$Z = \overline{Z_1 \oplus \dots \oplus Z_t}.$$

the **generic decomposition** of Z .

Schofield [Scho92] gave an algorithm which computes the generic decomposition for all $Z \in \text{Irr}(A)$ in case $A = KQ$ is the path algebra of an acyclic quiver Q .

Theorem 15.20 (Schofield [Scho92]). *Assume that A is hereditary. Then for each $Z \in \text{Irr}(A)$ there is an algorithm which computes the generic decomposition of Z .*

15.3. g -vectors of irreducible components. Let $P(1), \dots, P(n)$ be the indecomposable projective A -modules, up to isomorphism. For $P \in \text{proj}(A)$ and $1 \leq i \leq n$ let $[P : P(i)]$ be the multiplicity of $P(i)$ in P , i.e. we have

$$P \cong P(1)^{[P:P(1)]} \oplus \dots \oplus P(n)^{[P:P(n)]}.$$

For $M \in \text{mod}(A)$ let

$$P_1 \rightarrow P_0 \rightarrow M \rightarrow 0$$

be a minimal projective presentation of M .

For $1 \leq i \leq n$ let

$$g_i := g_i(M) := [P_1 : P(i)] - [P_0 : P(i)].$$

Then

$$g(M) := (g_1, \dots, g_n) \in \mathbb{Z}^n$$

is the **g -vector** of M .

Proposition 15.21. *For $M \in \text{mod}(A)$ and $1 \leq i \leq n$ we have*

$$g_i(M) = -\dim \text{Hom}_A(M, S(i)) + \dim \text{Ext}_A^1(M, S(i)).$$

Corollary 15.22. *For each $Z \in \text{Irr}(A)$ there exists a dense open subset $U \subseteq Z$ such that $g(M) = g(N)$ for all $M, N \in U$.*

In this case, $g(Z) := g(M)$ with $M \in U$ is the **g -vector** of Z .

The additive categorification of Fomin-Zelevinsky cluster algebras highlights the importance of g -vectors of modules and irreducible components. In this context, one studies $A = \mathcal{P}(Q, S)$, the Jacobian algebra associated with a quiver Q and a non-degenerate potential S for Q .

15.4. τ -reduced components.

For $Z \in \text{Irr}(A, d)$ let

$$c(Z) := \min\{\dim(Z) - \dim(\mathcal{O}_M) \mid M \in Z\}$$

be the **generic number of parameters** of Z .

Thus $c(Z) = 0$ if and only if there is some $M \in Z$ with $Z = \overline{\mathcal{O}_M}$.

Let

$$\begin{aligned} e(Z) &:= \min\{\dim \text{Ext}_A^1(M, M) \mid M \in Z\}, \\ h(Z) &:= \min\{\dim \text{Hom}_A(M, \tau_A(M)) \mid M \in Z\}. \end{aligned}$$

Here τ_A denote the Auslander-Reiten translation for A .

By upper semicontinuity the sets

$$\begin{aligned} &\{M \in Z \mid \dim(Z) - \dim(\mathcal{O}_M) = c(Z)\}, \\ &\{M \in Z \mid \dim \text{Ext}_A^1(M, M) = e(Z)\}, \\ &\{M \in Z \mid \dim \text{Hom}_A(M, \tau_A(M)) = h(Z)\} \end{aligned}$$

are dense open subsets of Z . For the first two sets this is well known. For the third set we refer to [GLFS23].

Proposition 15.23. *We have $c(Z) \leq e(Z) \leq h(Z)$.*

Proof. Use Voigt’s Lemma and the Auslander-Reiten formulas. □

We call Z **generically reduced** (resp. **generically τ -reduced**) if $c(Z) = e(Z)$ (resp. $c(Z) = h(Z)$).

Let
$$\text{Irr}^\tau(A) := \{Z \in \text{Irr}(A) \mid Z \text{ is generically } \tau\text{-reduced}\}.$$

There is an obvious dual notion of **generically τ^- -reduced irreducible components**.

Generically τ -reduced components (under the name *strongly reduced components*) were introduced and studied in [GLS12]. They play an important role in the construction of good bases for Fomin-Zelevinsky cluster algebras.

$M \in \text{mod}(A)$ is **τ -rigid** if $\text{Hom}_A(M, \tau_A(M)) = 0$.

Examples:

- (i) Let $M \in \text{mod}(A)$ be τ -rigid. Then

$$Z := \overline{\mathcal{O}_M} \in \text{Irr}^\tau(A).$$

- (ii) Let A be hereditary. Then $\text{Irr}^\tau(A) = \text{Irr}(A)$.
- (iii) Let $A = KQ/I$ where Q is the quiver

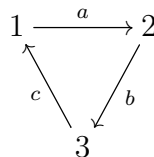

and I is generated by $\{ba, cb, ac\}$. Let M be the A -module given by

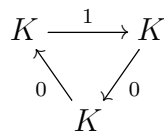

Then $Z := \overline{\mathcal{O}_M} \in \text{Irr}(A, 3)$, and we have $c(Z) = e(Z) = 0$ and $h(Z) = 1$.

(iv) Let $A = KQ/I$ where Q is the quiver

$$a \begin{array}{c} \circ \\ \curvearrowright \\ 1 \end{array}$$

and I is generated by a^2 . Let S be the A -module given by

$$0 \begin{array}{c} \circ \\ \curvearrowright \\ K \end{array}$$

Thus S is the simple A -module. Then $Z := \overline{\mathcal{O}_S} \in \text{Irr}(A, 1)$. (In fact, we have $Z = \mathcal{O}_S = \text{mod}(A, 1)$.) We have $c(Z) = 0$ and $e(Z) = h(Z) = 1$.

(v) Let $A = KQ/I$ where Q is the quiver

$$a \begin{array}{c} \circ \\ \curvearrowright \\ 1 \end{array} \begin{array}{c} \circ \\ \curvearrowright \\ b \end{array}$$

and I is generated by $\{a^2, b^2, ab - ba\}$. Then $P = {}_A A$ is indecomposable projective-injective. For $M = P/\text{soc}(P)$ we have $\tau_A(M) \cong \text{rad}(P)$. Then $Z := \overline{\mathcal{O}_M} \in \text{Irr}(A, 3)$, and we have $c(Z) = 0$, $e(Z) = 2$ and $h(Z) = 3$.

For $Z_1, Z_2 \in \text{Irr}(A)$ define

$$h(Z_1, Z_2) := \min\{\dim \text{Hom}_A(M_1, \tau_A(M_2)) \mid (M_1, M_2) \in Z_1 \times Z_2\}.$$

By upper semicontinuity the set

$$\{(M_1, M_2) \in Z_1 \times Z_2 \mid \dim \text{Hom}_A(M_1, \tau_A(M_2)) = h(Z_1, Z_2)\}$$

is a dense open subset of $Z_1 \times Z_2$, see [GLFS23].

Theorem 15.24 ([CLS15, Theorem 1.3]). *For $Z_1, \dots, Z_t \in \text{Irr}^\tau(A)$ the following are equivalent:*

- (i) $\overline{Z_1 \oplus \dots \oplus Z_t} \in \text{Irr}^\tau(A)$;
- (ii) $h(Z_i, Z_j) = 0$ for all $i \neq j$.

A beautiful result by Plamondon [P13] says that one can describe and parametrize the generically τ -reduced components quite explicitly.

Let $S(1), \dots, S(n)$ be the simple A -modules, up to isomorphism.

For $Z \in \text{Irr}(A)$ let

$$g(Z)^\circ := g(Z) + \sum_{i \in \text{null}(Z)} \mathbb{N}e_i.$$

where $\text{null}(Z) := \{1 \leq i \leq n \mid [Z : S(i)] = 0\}$.

Theorem 15.25 (Plamondon [P13]). *We have*

$$\mathbb{Z}^n = \bigcup_{Z \in \text{Irr}^\tau(A)} g(Z)^\circ$$

and this union is disjoint.

Corollary 15.26. *The map*

$$\begin{aligned} \eta: \text{Irr}^\tau(A) &\rightarrow \mathbb{Z}^n \\ Z &\mapsto g(Z) \end{aligned}$$

is injective.

The proof of Theorem 15.25 is based on the following result:

Theorem 15.27 (Plamondon [P13]). *Given $(P_1, P_0) \in \text{proj}(A) \times \text{proj}(A)$ the following hold:*

- (i) *There exists a unique $Z \in \text{Irr}(A)$ such that there is a dense open subset U of $\text{Hom}_A(P_1, P_0)$ with*

$$\overline{\bigcup_{f \in U} \mathcal{O}_{\text{Cok}(f)}} = Z.$$

- (ii) *The component Z is generically τ -reduced, and all generically τ -reduced components arise in this way.*

In the situation of the previous theorem one can assume without loss of generality that $\text{add}(P_1) \cap \text{add}(P_0) = 0$.

A is **τ -tilting finite** if there are only finitely many indecomposable τ -rigid modules in $\text{mod}(A)$, up to isomorphism.

The following theorem can be extracted from [A21, Theorem 4.7] and [DIJ19, Theorem 5.4, Corollary 6.7].

Theorem 15.28. *The following are equivalent:*

- (i) *A is τ -tilting finite;*
 (iii) *Each $Z \in \text{Irr}^\tau(A)$ is of the form $Z = \overline{\mathcal{O}_M}$ for some τ -rigid $M \in \text{mod}(A)$.*

15.5. Additive invariants for irreducible components. The following definition is taken from [Sch23].

Let $r \geq 1$. An **additive invariant** for $\text{Irr}(A)$ is a map

$$\eta: \text{Irr}(A) \rightarrow \mathbb{Z}^r$$

such that for all $Z_1, Z_2 \in \text{Irr}(A)$ with $\overline{Z_1 \oplus Z_2} \in \text{Irr}(A)$ we have

$$\eta(Z) = \eta(Z_1) + \eta(Z_2).$$

An additive invariant $\eta: \text{Irr}(A) \rightarrow \mathbb{Z}^r$ is **complete** if η is injective.

Examples:

- (i) Let $n = n(A)$. Then $\text{Irr}(A) \rightarrow \mathbb{Z}^n$, $Z \mapsto \underline{\dim}(Z)$ is an additive invariant. This is complete if and only if A is geometrically irreducible.
- (ii) Let $n = n(A)$. Then $\text{Irr}(A) \rightarrow \mathbb{Z}^n$, $Z \mapsto g(Z)$ is an additive invariant.
- (iii) Let A be torsionfree finite, and let r be the number of indecomposable torsionfree A -modules, up to isomorphism. Then there is a complete additive invariant $\text{Irr}(A) \rightarrow \mathbb{Z}^r$, see [Sch23].
- (iv) Let $A = \Pi(Q)$ be the preprojective algebra of some Dynkin quiver Q , and let r be the number of indecomposable KQ -modules, up to isomorphism. Then there is a complete additive invariant $\text{Irr}(A) \rightarrow \mathbb{Z}^r$. (This follows from Lusztig's work, see [Sch23] for references.)
- (v) For $n \geq 2$ and $r \geq 1$ let A be n -representation-infinite. Then there is no complete additive invariant $\text{Irr}(A) \rightarrow \mathbb{Z}^r$, see [Sch23].

15.6. Varieties of modules and tame algebras.

For $d \geq 1$ and $1 \leq t \leq d^2$ let

$$\begin{aligned} \text{mod}(A, d, t) &:= \{M \in \text{mod}(A, d) \mid \dim \mathcal{O}_M \leq d^2 - t\} \\ &= \{M \in \text{mod}(A, d) \mid \dim \text{End}_A(M) \geq t\}. \end{aligned}$$

The $\text{mod}(A, d, t)$ are closed subsets of $\text{mod}(A, d)$ with

$$\text{mod}(A, d, t^2) \subseteq \cdots \subseteq \text{mod}(A, d, 2) \subseteq \text{mod}(A, d, 1).$$

Note that $\text{mod}(A, d, 1) = \text{mod}(A, d)$.

The following is a direct consequence of Proposition 15.3.

Proposition 15.29. *The following are equivalent:*

- (i) *A is representation-finite.*
- (ii) *For each $d \geq 1$ there exists some finite subset $C \subseteq \text{mod}(A, d)$ such that*

$$\text{GL}_d(K)C = \text{mod}(A, d).$$
- (iii) *For each $d \geq 1$ and $1 \leq t \leq d^2$ we have*

$$\dim \text{mod}(A, d, t) \leq d^2 - t.$$

Corollary 15.30. *If A is representation-finite, then $\dim \text{mod}(A, d) \leq d^2 - 1$ for each $d \geq 1$.*

Theorem 15.31 ([G95, Proposition 2], [P91b, Theorem 1.3]). *The following are equivalent:*

- (i) *A is tame.*
- (ii) *For each $d \geq 1$ there exists some constructible subset $C \subseteq \text{mod}(A, d)$ with $\dim C \leq d$ such that*

$$\text{GL}_d(K)C = \text{mod}(A, d).$$
- (iii) *For each $d \geq 1$ there exists some constructible subset $C \subseteq \text{ind}(A, d)$ with $\dim C \leq 1$ such that*

$$\text{GL}_d(K)C = \text{ind}(A, d).$$
- (iv) *For each $d \geq 1$ and $1 \leq t \leq d^2$ we have*

$$\dim \text{mod}(A, d, t) \leq d + (d^2 - t).$$

Corollary 15.32. *If A is tame, then $\dim \text{mod}(A, d) \leq d^2 + d - 1$ for each $d \geq 1$.*

15.7. Richmond stratification. For $d \geq 0$ let $\mathcal{S}(d)$ be the set of isomorphism classes $[L]$ of submodules L of A^d with $\dim(L) = \dim(A^d) - d$.

For $[L] \in \mathcal{S}(d)$ let $\mathcal{S}(L)$ be the set of all $M \in \text{mod}(A, d)$ such that there exists a short exact

$$0 \rightarrow L \rightarrow A^d \rightarrow M \rightarrow 0.$$

We call $\mathcal{S}(L)$ a **Richmond stratum** of $\text{mod}(A, d)$.

Lemma 15.33. $\text{mod}(A, d)$ is the disjoint union of its Richmond strata.

Theorem 15.34 (Richmond [Ri01, Theorem 1]). $\mathcal{S}(L)$ is an irreducible locally closed subset of $\text{mod}(A, d)$ with

$$\dim \mathcal{S}(L) = \dim \text{Hom}_A(L, A^d) - \dim \text{End}_A(L).$$

Recall that $M \in \text{mod}(A)$ is **torsionless** if M is isomorphic to a submodule of A^d for some d .

The algebra A is **torsionless-finite** if there are only finitely many indecomposable torsionless A -modules up to isomorphism.

Example: String algebras are torsionless-finite.

The following is a direct consequence of the irreducibility of Richmond strata.

Proposition 15.35. Let A be torsionless-finite. Then for each $Z \in \text{Irr}(A)$ there is a unique Richmond stratum $\mathcal{S}(L)$ with $Z = \overline{\mathcal{S}(L)}$.

Especially for torsionless-finite algebra, the Richmond stratification is a useful tool for classifying and understanding the irreducible components of varieties of modules, see for example [Sch04].

Theorem 15.36 (Richmond [Ri01, Theorem 2]). For $[L], [L'] \in \mathcal{S}(d)$ the following hold:

- (i) If $\mathcal{S}(L') \subseteq \overline{\mathcal{S}(L)}$, then $L \leq_{\text{deg}} L'$;
- (ii) If $L \leq_{\text{deg}} L'$ and $\dim \text{Hom}_A(L, A) = \dim \text{Hom}_A(L', A)$, then $\mathcal{S}(L') \subseteq \overline{\mathcal{S}(L)}$.

Examples:

- (i) Let A be hereditary. Then $\text{Irr}(A, d)$ is the set of connected components of $\text{mod}(A, d)$, and the Richmond strata of $\text{mod}(A, d)$ coincide with the irreducible components.
- (ii) Let A be selfinjective. Then the Richmond strata of $\text{mod}(A, d)$ coincide with the orbits \mathcal{O}_M with $M \in \text{mod}(A, d)$.

(iii) We have

$$\{M \in \text{mod}(A) \mid \text{proj. dim}(M) \leq 1\} = \bigcup_{\substack{[L] \in \mathcal{S}(d) \\ L \text{ projective}}} \mathcal{S}(L).$$

15.8. Varieties of algebras. For $d \geq 0$ the d -dimensional K -algebras form an affine variety $\text{alg}(d)$. The elements of $\text{alg}(d)$ can also be seen as the closed points of an affine scheme $\mathbf{alg}(d)$ which is defined by polynomials in d^3 variables.

The group $\text{GL}_d(K)$ acts on $\text{alg}(d)$ by conjugation. The orbits of this action correspond to the isomorphism classes of d -dimensional K -algebras. The orbit of an algebra A is denoted by \mathcal{O}_A . Let \mathcal{O}_A also denote the corresponding orbit in $\mathbf{alg}(d)$.

For $i \geq 0$ and an A - A -bimodule M let $H^i(A, M)$ be the i -th Hochschild cohomology group.

For $A \in \text{alg}(d)$ let T_A (resp. \mathbf{T}_A) be the tangent space of $\text{alg}(d)$ (resp. $\mathbf{alg}(d)$) at A , and let T_A° be the tangent space of \mathcal{O}_A at A . We have $\dim T_A^\circ = \dim \mathcal{O}_A$.

Theorem 15.37 ([G74, Proposition 2.4]). *For $A \in \text{alg}(d)$ there is an injective map*

$$T_A/T_A^\circ \rightarrow H^2(A, A)$$

and an isomorphism

$$\mathbf{T}_A/T_A^\circ \rightarrow H^2(A, A).$$

Corollary 15.38 ([G74, Corollary 2.5]). *For $A \in \text{alg}(d)$ the following are equivalent:*

- (i) \mathcal{O}_A is an open subscheme of $\mathbf{alg}(d)$;
- (ii) $H^2(A, A) = 0$.

Corollary 15.39 ([G74, Corollary 2.6]). *Let $A \in \text{alg}(d)$. If $\text{gl. dim}(A) \leq 1$, then \mathcal{O}_A is an open subscheme of $\mathbf{alg}(d)$.*

Corollary 15.40. *Let $A \in \text{alg}(d)$. If $H^2(A, A) = 0$, then \mathcal{O}_A is open in $\mathbf{alg}(d)$.*

Proposition 15.41 ([G74, Proposition 2.2]). *For $d \geq 1$ and $A \in \text{alg}(d)$ the following are equivalent:*

- (i) \mathcal{O}_A is closed;
- (ii) $A \cong K[X_1, \dots, X_{d-1}]/(X_i X_j \mid 1 \leq i, j \leq d-1)$.

Corollary 15.42. $\text{alg}(d)$ is connected.

Not much is known about the irreducible components of the varieties $\text{alg}(d)$. Gabriel [G74] described them for $d \leq 4$. The case $d = 5$ is studied in [H79] and [M79]. We refer to [DPS98] for further results in this direction.

Let $J(A)$ be the Jacobson radical of A . Recall that A is semisimple if and only if $J(A) = 0$.

Proposition 15.43 ([G74, Proposition 2.7]). For $s \geq 0$ the set

$$\{A \in \text{alg}(d) \mid \dim J(A) \leq s\}$$

is open in $\text{alg}(d)$. In particular, the d -dimensional semisimple K -algebras form an open subset of $\text{alg}(d)$.

Theorem 15.44 (Gabriel [G74, Theorem 4.2]). The d -dimensional representation-finite K -algebras form an open subset of $\text{alg}(d)$.

For refinements of Theorem 15.44 we refer to Kasjan's work [K02a, K03, K13].

Conjecture 15.45 (Geiß [G95, G96]). The d -dimensional tame K -algebras form an open subset of $\text{alg}(d)$.

For further reading related to Conjecture 15.45 see [H05, K02b, K07].

Problem 15.46 (Ringel [R02, Problem 15]). Let $n, d \geq 1$. Is the class of d -dimensional K -algebras which are m -domestic with $m \leq n$ open in $\text{alg}(d)$?

For $A, B \in \text{alg}(d)$ with $B \in \overline{\mathcal{O}_A}$ we say that B is a **degeneration** of A , and A is a **deformation** of B .

Theorem 15.47 (Geiß [G96, Theorem 4.4]). Deformations of tame (resp. representation-finite) algebras are tame (resp. representation-finite).

Hierarchy of complexity of the representation types of algebras:

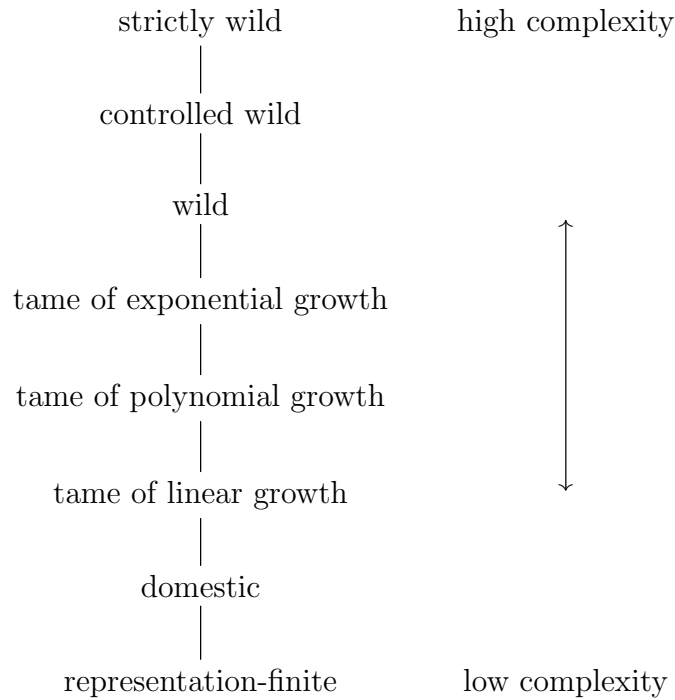

Conjecture 15.48 (Geiß). *Suppose that*

$$B \in \overline{\mathcal{O}}_A.$$

Then the representation type of B is at least as complex as the representation type of A .

Here is a more general definition of deformations of algebras:

Theorem 15.49 (Crawley-Boevey[CB95, Theorem B]). *Let A be a finite-dimensional K -algebra, and let X be an irreducible variety. Consider morphisms*

$$f_1, \dots, f_r: X \rightarrow A.$$

For $x \in X$ let $A_x := A/(f_1(x), \dots, f_r(x))$. Let $x_0, x_1 \in X$ such that the following hold:

(i) A_{x_0} is tame.

(ii) There is a dense open subset $U \subseteq X$ with $A_x \cong A_{x_1}$ for all $x_1 \in U$.

Then A_{x_1} is tame.

In the situation of this theorem, A_{x_0} is a **degeneration** of A_{x_1} , and A_{x_1} is a **deformation** of A_{x_0} .

Theorem 15.49 is mostly applied with $X = K$ being the affine line.

In Geiß's definition one deforms the structure constants of an algebra whereas in Crawley-Boevey's definition one deforms the relations. Crawley-Boevey [CB95] pointed out that one can refine both definitions and deform structure constants and relations at the same time.

Example: Let $\lambda \in K$, and let $A_\lambda = KQ/I_\lambda$ where Q is the quiver



and the ideal I_λ is generated by

$$\{(ab)^2 - (ba)^2, a^2 - \lambda bab, b^2 - \lambda aba, (ab)^2 a, (ba)^2 b\}.$$

(If $\text{char}(K) = 2$, then A_1 is isomorphic to the group algebra KQ_8 of the quaternion group Q_8 .) Note that $A_\lambda \cong A_1$ for all $\lambda \neq 0$. The algebra A_0 is special biserial (and therefore known to be tame). We want to show that A_1 is a deformation of A_0 . With the same quiver Q let $B = KQ/I$ where the ideal I is generated by

$$\{(ab)^2 - (ba)^2, p \mid p \text{ is a path of length } 5\}.$$

Define $f_1, f_2: K \rightarrow B$ by $f_1(\lambda) := a^2 - \lambda bab$ and $f_2(\lambda) := b^2 - \lambda aba$. Then $B/(f_1(\lambda), f_2(\lambda)) \cong A_\lambda$ for each $\lambda \in K$. Thus we are in the situation of Theorem 15.49 and can conclude that A_1 is tame.

Problem 15.50 (Ringel [R02, Problem 16]). *Describe the deformations of special biserial algebras.*

Theorem 15.51 (Crawley-Boevey [CB95]). *Biserial algebras are deformations of special biserial algebras.*

The classification of tame Jacobian algebras $\mathcal{P}(Q, S)$, where Q is a 2-acyclic quiver and S is a non-degenerate potential for Q , relies heavily on the fact that many tame Jacobian algebras are deformations of special biserial algebras, see [GLFS16, Sections 6 and 7].

LITERATURE – GEOMETRIC CONJECTURES

- [A21] S. Asai, *The wall-chamber structures of the real Grothendieck groups*. Adv. Math. 381 (2021), Paper No. 107615, 44 pp.
- [B91] K. Bongartz, *A geometric version of the Morita equivalence*. J. Algebra 139 (1991), no. 1, 159–171.
- [B96] K. Bongartz, *On degenerations and extensions of finite-dimensional modules*. Adv. Math. 121 (1996), no. 2, 245–287.
- [CLS15] G. Cerulli Irelli, D. Labardini-Fragoso, J. Schröer, *Caldero-Chapoton algebras*. Trans. Amer. Math. Soc. 367 (2015), no. 4, 2787–2822.
- [CB93] W. Crawley-Boevey, *Geometry of representations of algebras*. Lecture notes (1993), 39 pp., Oxford University.
- [CB95] W. Crawley-Boevey, *Tameness of biserial algebras*. Arch. Math. (Basel) 65 (1995), no. 5, 399–407.

- [CB20] W. Crawley-Boevey, *Noncommutative Algebra 3: Geometric methods for representations of algebras*. Lecture notes (2020), 95 pp., Bielefeld University.
- [CBS02] W. Crawley-Boevey, J. Schröer, *Irreducible components of varieties of modules*. J. Reine Angew. Math. 553 (2002), 201–220.
- [DPS98] T. Dana-Picard, M. Schaps, *Non-reduced components of Alg_n* . In: Algebras and modules, II (Geiranger, 1996), 111–120, CMS Conf. Proc., 24, Amer. Math. Soc., Providence, RI, 1998.
- [DIJ19] L. Demonet, O. Iyama, G. Jasso, *τ -tilting finite algebras, bricks, and g -vectors*. Int. Math. Res. Not. IMRN 2019, no. 3, 852–892.
- [DF15] H. Derksen, J. Fei, *General presentations of algebras*. Adv. Math. 278 (2015), 210–237.
- [G74] P. Gabriel, *Finite representation type is open*. Proceedings of the International Conference on Representations of Algebras (Carleton Univ., Ottawa, Ont., 1974), Paper No. 10, 23 pp. Carleton Math. Lecture Notes, No. 9, Carleton Univ., Ottawa, Ont., 1974.
- [GLFS16] C. Geiß, D. Labardini-Fragoso, J. Schröer, *The representation type of Jacobian algebras*. Adv. Math. 290 (2016), 364–452.
- [GLFS23] C. Geiß, D. Labardini-Fragoso, J. Schröer, *Semicontinuous maps on module varieties*. Preprint (2023), 18 pp.
- [GLS12] C. Geiß, D. Leclerc, J. Schröer, *Generic bases for cluster algebras and the Chamber Ansatz*. J. Amer. Math. Soc. 25 (2012), no. 1, 21–76.
- [GP95] C. Geiß, J.A. de la Peña, *On the deformation theory of finite-dimensional algebras*. Manuscripta Math. 88 (1995), no. 2, 191–208.
- [G95] C. Geiß, *On degenerations of tame and wild algebras*. Arch. Math. (Basel) 64 (1995), no. 1, 11–16.
- [G96] C. Geiß, *Geometric methods in representation theory of finite-dimensional algebras*. Representation theory of algebras and related topics (Mexico City, 1994), 53–63, CMS Conf. Proc., 19, Amer. Math. Soc., Providence, RI, 1996.
- [G64] M. Gerstenhaber, *On deformations of rings and algebras*. Ann. of Math. (2) 79 (1964), 59–103.
- [H05] Y. Han, *Is tame open?* J. Algebra 284 (2005), no. 2, 801–810.
- [H79] D. Happel, *Deformations of five-dimensional algebras with unit*. Ring theory (Proc. Antwerp Conf. (NATO Adv. Study Inst.), Univ. Antwerp, Antwerp, 1978), pp. 459–494, Lecture Notes in Pure and Appl. Math., 51, Dekker, New York, 1979.
- [M79] G. Mazzola, *The algebraic and geometric classification of associative algebras of dimension five*. Manuscripta Math. 27 (1979), no. 1, 81–101.
- [Hu17] A. Hubery, *Irreducible components of quiver Grassmannians*. Trans. Amer. Math. Soc. 369 (2017), no. 2, 1395–1458.
- [K02a] S. Kasjan, *Representation-directed algebras form an open scheme*. Colloq. Math. 93 (2002), no. 2, 237–250.
- [K02b] S. Kasjan, *On the problem of axiomatization of tame representation type*. Fund. Math. 171 (2002), 53–67.
- [K03] S. Kasjan, *Representation-finite triangular algebras form an open scheme*. Cent. Eur. J. Math. 1 (2003), no. 1, 97–107.
- [K07] S. Kasjan, *Tame strongly simply connected algebras form an open scheme*. J. Pure Appl. Algebra 208 (2007), no. 2, 435–443.
- [K13] S. Kasjan, *Representation-finite algebras over algebraically closed fields form open \mathbb{Z} -schemes*. Bull. Lond. Math. Soc. 45 (2013), no. 3, 595–601.
- [K94] A. King, *Moduli of representations of finite-dimensional algebras*. Quart. J. Math. Oxford Ser. (2) 45 (1994), no. 180, 515–530.
- [K84] H. Kraft, *Geometrische Methoden in der Invariantentheorie*. (German) Aspects of Mathematics, D1. Friedr. Vieweg & Sohn, Braunschweig, 1984. x+308 pp.
- [K82] H. Kraft, *Geometric methods in representation theory*. In: Representations of algebras (Puebla, 1980), pp. 180–258, Lecture Notes in Math., 944, Springer, Berlin-New York, 1982.
- [M80] K. Morrison, *The scheme of finite-dimensional representations of an algebra*. Pacific J. Math. 91 (1980), no. 1, 199–218.

- [P91a] J.A. de la Peña, *On the dimension of the module varieties of tame and wild algebras*. Comm. Algebra 19 (1991), no. 6, 1795–1807.
- [P91b] J.A. de la Peña, *Functors preserving tameness*. Fund. Math. 137 (1991), no. 3, 177–185.
- [P13] P.-G. Plamondon, *Generic bases for cluster algebras from the cluster category*. Int. Math. Res. Not. IMRN 2013, no. 10, 2368–2420.
- [P74] C. Procesi, *Finite dimensional representations of algebras*. Israel J. Math. 19 (1974), 169–182.
- [Rei03] M. Reineke, *The Harder-Narasimhan system in quantum groups and cohomology of quiver moduli*. Invent. Math. 152, 349–368 (2003).
- [Ri01] N. Richmond, *A stratification for varieties of modules*. Bull. London Math. Soc. 33 (2001), no. 5, 565–577.
- [R86] C. Riedtmann, *Degenerations for representations of quivers with relations*. Ann. Sci. École Norm. Sup. (4) 19 (1986), no. 2, 275–301.
- [R02] C.M. Ringel, *Combinatorial representation theory history and future*. Representations of algebra. Vol. I, II, 122–144, Beijing Norm. Univ. Press, Beijing, 2002.
- [Scho92] A.H. Schofield, *General representations of quivers*. Proc. London Math. Soc. (3) 65 (1992), no. 1, 46–64.
- [Sch04] J. Schröer, *Varieties of pairs of nilpotent matrices annihilating each other*. Comment. Math. Helv. 79 (2004), no. 2, 396–426.
- [Sch23] J. Schröer, *Additive invariants for irreducible components of module varieties*. Preprint (2023).
- [V77] D. Voigt, *Induzierte Darstellungen in der Theorie der endlichen, algebraischen Gruppen*. (German) Mit einer englischen Einführung. Lecture Notes in Mathematics, Vol. 592. Springer-Verlag, Berlin-New York, 1977. iv+413 pp.
- [Z99] G. Zwara, *Degenerations for modules over representation-finite algebras*. Proc. Amer. Math. Soc. 127 (1999), no. 5, 1313–1322.
- [Z00] G. Zwara, *Degenerations of finite-dimensional modules are given by extensions*. Compositio Math. 121 (2000), no. 2, 205–218.

16. Subcategories

Let A be a finite-dimensional K -algebra. This section provides an incomplete list of frequently studied subcategories of $\text{mod}(A)$.

16.1. Exact subcategories and Frobenius subcategories. Let A be a finite-dimensional K -algebra.

A full subcategory \mathcal{C} of $\text{mod}(A)$ is an **full exact subcategory** if $0 \in \mathcal{C}$ and \mathcal{C} is closed under extensions, i.e. for each short exact sequence

$$0 \rightarrow X \rightarrow Y \rightarrow Z \rightarrow 0$$

in $\text{mod}(A)$ with $X, Z \in \mathcal{C}$ we have $Y \in \mathcal{C}$.

In this case, \mathcal{C} is additive and closed under isomorphisms.

Each full exact subcategory is an exact subcategory.

(The definition of an exact subcategory can be found in the Section [A](#).)

Let \mathcal{C} be a full exact subcategory of $\text{mod}(A)$. Then $X \in \mathcal{C}$ is **\mathcal{C} -projective** (resp. **\mathcal{C} -injective**) if $\text{Ext}_A^1(X, \mathcal{C}) = 0$ (resp. $\text{Ext}_A^1(\mathcal{C}, X) = 0$). The subcategory \mathcal{C} has **enough projectives** (resp. **enough injectives**) if for each $X \in \mathcal{C}$ there exists a \mathcal{C} -projective $P(X)$ (resp. a \mathcal{C} -injective $I(X)$) and a short exact sequence

$$0 \rightarrow X' \rightarrow P(X) \rightarrow X \rightarrow 0 \quad (\text{resp. } 0 \rightarrow X \rightarrow I(X) \rightarrow X' \rightarrow 0)$$

with $X' \in \mathcal{C}$.

A full exact subcategory \mathcal{F} of $\text{mod}(A)$ is a **Frobenius subcategory** if the following hold:

- (i) \mathcal{F} has enough projectives;
- (ii) \mathcal{F} has enough injectives;
- (iii) An object is \mathcal{C} -projective if and only if it is \mathcal{C} -injective.

Full exact subcategories and Frobenius subcategories of $\text{mod}(A)$ play an important role in many different contexts. The stable category of a Frobenius subcategory is triangulated.

Examples: Let A be a finite-dimensional K -algebra.

- (i) If A is quasi-hereditary, then the category $\mathcal{F}(\Delta)$ of Δ -filtered A -modules is a full exact subcategory of $\text{mod}(A)$, see e.g. [\[R92\]](#).
- (ii) The category $\text{gp}(A)$ of Gorenstein projective A -modules is a Frobenius subcategory of $\text{mod}(A)$, see e.g. [\[B05, Proposition 3.8\]](#).

- (iii) If A is selfinjective, then $\text{mod}(A)$ is a Frobenius category. (This is a special case of (ii).)
- (iv) Let $A = \Pi(Q)$ be the (possibly infinite-dimensional) preprojective algebra of an acyclic quiver Q . To each element w of the Weyl group W associated with Q one can construct a Frobenius subcategory \mathcal{C}_w of $\text{mod}(A)$ such that \mathcal{C}_w categorifies a Fomin-Zelevinsky cluster algebra, see [BIRS09] and [GLS11].
- (v) Let Q be the quiver

$$1 \xleftarrow{a} 2 \xleftarrow{b} 3$$

and let $A = KQ$. The AR quiver Γ_A looks as follows (each number i stands for a composition factor $S(i)$):

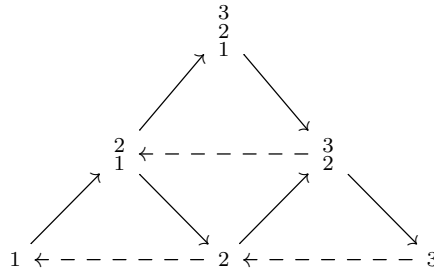

Then

$$\mathcal{C} := \text{add} \left(\begin{smallmatrix} 2 \\ 1 \end{smallmatrix} \oplus \begin{smallmatrix} 3 \\ 2 \\ 1 \end{smallmatrix} \oplus 2 \oplus \begin{smallmatrix} 3 \\ 2 \end{smallmatrix} \right)$$

is a full exact subcategory of $\text{mod}(A)$. We have

$$\text{proj}(\mathcal{C}) = \text{add} \left(\begin{smallmatrix} 2 \\ 1 \end{smallmatrix} \oplus \begin{smallmatrix} 3 \\ 2 \\ 1 \end{smallmatrix} \oplus 2 \right) \quad \text{and} \quad \text{inj}(\mathcal{C}) = \text{add} \left(\begin{smallmatrix} 3 \\ 2 \\ 1 \end{smallmatrix} \oplus 2 \oplus \begin{smallmatrix} 3 \\ 2 \end{smallmatrix} \right).$$

The category \mathcal{C} has enough projectives and enough injectives, but it is not a Frobenius subcategory.

- (vi) Let Q be the quiver

$$1 \xleftarrow{a} 2 \xleftarrow{b} 3$$

and let $A = \Pi(Q)$ be the associated preprojective algebra, i.e. $A = K\overline{Q}/I$ where \overline{Q} is the quiver

$$1 \xrightleftharpoons[a^*]{a} 2 \xrightleftharpoons[b^*]{b} 3$$

and I is generated by $\{aa^*, bb^* - a^*a, -b^*b\}$. There are 12 indecomposable A -modules, up to isomorphism. The AR quiver Γ_A looks as follows (each

number i stands for a composition factor $S(i)$):

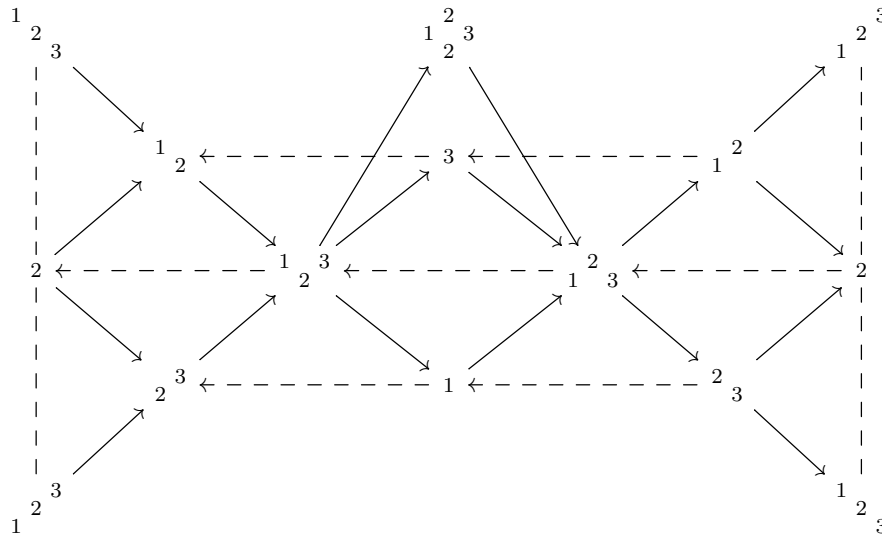

(One needs to identify the modules on the left dashed vertical line with the modules on the right dashed vertical line in the obvious way.) Then

$$\mathcal{C} := \text{add} \left(1 \oplus 2 \oplus 1_2 \oplus 1^2 \oplus 1_2^3 \right)$$

is a Frobenius subcategory of $\text{mod}(A)$ with

$$\text{proj}(\mathcal{C}) = \text{inj}(\mathcal{C}) = \text{add} \left(1_2 \oplus 1^2 \oplus 1_2^3 \right).$$

LITERATURE – EXACT SUBCATEGORIES

- [B05] A. Beligiannis, *Cohen-Macaulay modules, (co)torsion pairs and virtually Gorenstein algebras*. J. Algebra 288 (2005), no. 1, 137–211.
- [BIRS09] A. Buan, O. Iyama, I. Reiten, J. Scott, *Cluster structures for 2-Calabi-Yau categories and unipotent groups*. Compos. Math. 145 (2009), no. 4, 1035–1079.
- [B10] T. Bühler, *Exact categories*. Expo. Math. 28 (2010), no. 1, 1–69.
- [GLS11] C. Geiß, B. Leclerc, J. Schröer, *Kac-Moody groups and cluster algebras*. Adv. Math. 228 (2011), no. 1, 329–433.
- [R92] C.M. Ringel, *The category of good modules over a quasi-hereditary algebra*. Proceedings of the Sixth International Conference on Representations of Algebras (Ottawa, ON, 1992), 17 pp., Carleton-Ottawa Math. Lecture Note Ser., 14, Carleton Univ., Ottawa, ON, 1992.

16.2. **Abelian subcategories.** Let \mathcal{C} be a full subcategory of $\text{mod}(A)$.

\mathcal{C} is an **abelian subcategory** of $\text{mod}(A)$ if \mathcal{C} is additive and closed under kernels and cokernels.

Warning: It can happen that \mathcal{C} is abelian, but not an abelian subcategory. (For this reason, some authors call an abelian subcategory an *exact abelian subcategory*.)

Example: Let $A = KQ$ where Q is the quiver

$$1 \longleftarrow 2 \longleftarrow 3$$

The Auslander-Reiten quiver of A is

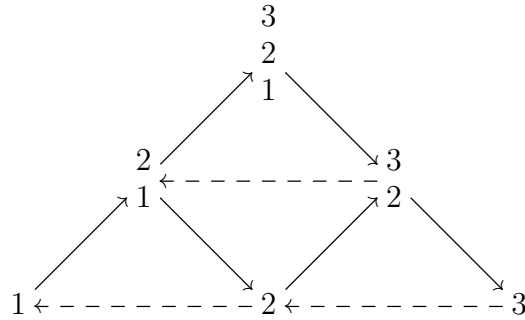

The subcategory

$$\mathcal{C} := \text{add} \begin{pmatrix} 3 \\ 1 \oplus 2 \oplus 3 \\ 1 \end{pmatrix}$$

is an abelian category which is equivalent to $\text{mod}(KQ')$ where Q' is the quiver

$$1 \longleftarrow 2$$

However \mathcal{C} is not an abelian subcategory, since \mathcal{C} is not closed under kernels and also not closed under cokernels. On the other hand,

$$\mathcal{D} := \text{add} \begin{pmatrix} 3 & 3 \\ 1 \oplus 2 \oplus 3 & 2 \\ 1 & 2 \end{pmatrix}$$

is an abelian subcategory of $\text{mod}(A)$. Note that \mathcal{D} is also equivalent to $\text{mod}(KQ')$.

Proposition 16.1. *The following are equivalent:*

- (i) \mathcal{C} is an abelian subcategory of $\text{mod}(A)$.
- (ii) \mathcal{C} is abelian and the inclusion functor $\mathcal{C} \rightarrow \text{mod}(A)$ is exact.

16.3. Wide subcategories. Let \mathcal{C} be a full subcategory of $\text{mod}(A)$.

\mathcal{C} is a **wide subcategory** of $\text{mod}(A)$ if \mathcal{C} is an abelian subcategory which is closed under extensions. Let $\text{wide}(A)$ be the set of wide subcategories of $\text{mod}(A)$.

For $X \in \text{mod}(A)$ let $[X]$ denotes its isomorphism class. For such a wide subcategory let

$$\mathcal{S}(\mathcal{C}) := \{[S] \mid S \text{ is simple in } \mathcal{C}\}.$$

(An object $S \in \mathcal{C}$ is **simple** in \mathcal{C} if S does not have a non-zero proper subobject U with $U \in \mathcal{C}$.)

$X \in \text{mod}(A)$ is a **brick** if $\text{End}_A(X)$ is a K -skew field, i.e. each non-zero endomorphism of X is an isomorphism. Let $\text{brick}(A)$ be the set of isomorphism classes of bricks in $\text{mod}(A)$.

Bricks are indecomposable.

A **semibrick** for A is a subset \mathcal{S} of $\text{brick}(A)$ such that $\text{Hom}_A(X, Y) = 0$ for all $[X], [Y] \in \mathcal{S}$ with $[X] \neq [Y]$. Let $\text{semibrick}(A)$ be the set of semibricks for A .

For such a semibrick \mathcal{S} let $\text{filt}(\mathcal{S})$ be the full subcategory of all $M \in \text{mod}(A)$ such that there exists a chain

$$0 = M_0 \subset M_1 \subset \cdots \subset M_t = M$$

of submodules with $[M_k/M_{k-1}] \in \mathcal{S}$ for all $1 \leq k \leq t$. We also assume that $0 \in \text{filt}(\mathcal{S})$. (In particular, for $\mathcal{S} = \emptyset$, we have $\text{filt}(\mathcal{S}) = 0$.)

Example: Let $A = KQ$ where Q is the Kronecker quiver

$$1 \xleftarrow{\quad} 2$$

and for $\lambda \in K$ let X_λ be the representation

$$K \xleftarrow[\lambda]{1} K$$

Then $\mathcal{S} = \{[X_\lambda] \mid \lambda \in K\}$ is a semibrick for A . Identifying $\text{mod}(A)$ and $\text{rep}(Q)$, the category $\text{filt}(\mathcal{S})$ consists of all finite-dimensional representations

$$V \xleftarrow[g]{f} W$$

such that f is an isomorphism.

Theorem 16.2 (Ringel [R76, Section 1]). *The maps*

$$\text{semibrick}(A) \longleftrightarrow \text{wide}(A)$$

$$\mathcal{S} \mapsto \text{filt}(\mathcal{S})$$

$$\mathcal{S}(\mathcal{C}) \leftrightarrow \mathcal{C}$$

are bijections which are inverses of each other.

LITERATURE – WIDE SUBCATEGORIES

[A20] S. Asai, *Semibricks*. Int. Math. Res. Not. IMRN 2020, no. 16, 4993–5054.

[R76] C.M. Ringel, *Representations of K -species and bimodules*. J. Algebra 41 (1976), no. 2, 269–302.

16.4. **Serre subcategories.** Let \mathcal{C} be a full subcategory of $\text{mod}(A)$.

\mathcal{C} is a **Serre subcategory** of $\text{mod}(A)$ if \mathcal{C} is additive and for each short exact sequence

$$0 \rightarrow X \rightarrow Y \rightarrow Z \rightarrow 0$$

in $\text{mod}(A)$ we have $Y \in \mathcal{C}$ if and only if $X, Z \in \mathcal{C}$.

16.5. **Thick subcategories.** Let \mathcal{C} be a full subcategory of $\text{mod}(A)$.

\mathcal{C} is a **thick subcategory** of $\text{mod}(A)$ if \mathcal{C} is additive, closed under direct summands, kernels of epimorphisms, cokernels of monomorphisms and extensions.

In this case, for each short exact sequence

$$0 \rightarrow X_1 \rightarrow X_2 \rightarrow X_3 \rightarrow 0$$

in $\text{mod}(A)$, if $X_i, X_j \in \mathcal{C}$ with $i \neq j$, then $X_1, X_2, X_3 \in \mathcal{C}$.

Proposition 16.3 (Vossieck). *Let A be hereditary. Then each thick subcategory of $\text{mod}(A)$ is an abelian subcategory.*

Examples:

(i) Let $A = KQ/I$ where Q is the quiver

$$1 \xleftarrow{a} 2 \xleftarrow{b} 3$$

and I is generated by ab . Thus A is not hereditary. The AR quiver Γ_A looks as follows:

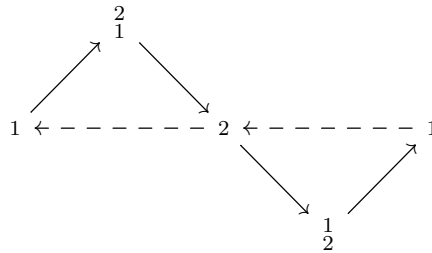

(One needs to identify the first and last module in the second row.) Then

$$\mathcal{C} := \text{add} \left(\begin{smallmatrix} 2 \\ 1 \end{smallmatrix} \oplus \begin{smallmatrix} 1 \\ 2 \end{smallmatrix} \right) = \text{proj}(A) = \text{inj}(A)$$

is a thick subcategory which is not abelian. More generally, for a finite-dimensional algebra A and $P \in \text{proj}(A) \cap \text{inj}(A)$, $\text{add}(P)$ is a thick subcategory of $\text{mod}(A)$.

(ii) For $M \in \text{mod}(A)$ the full subcategories

$$\{X \in \text{mod}(A) \mid \text{Ext}_A^n(M, X) = 0 \text{ for all } n \geq 0\}$$

and

$$\{X \in \text{mod}(A) \mid \text{Ext}_A^n(X, M) = 0 \text{ for all } n \geq 0\}$$

are thick.

(ii) The subcategories

$$\{X \in \text{mod}(A) \mid \text{proj. dim}(X) < \infty\}$$

and

$$\{X \in \text{mod}(A) \mid \text{inj. dim}(X) < \infty\}$$

are thick.

One can also define thick subcategories of triangulated categories. This is used more often than thick subcategories of abelian categories.

16.6. Resolving and coresolving subcategories.

\mathcal{C} is **resolving** if \mathcal{C} is closed under extensions, closed under kernels of epimorphisms, and if it contains $\text{proj}(A)$.

In this case, for $X \in \mathcal{C}$ the syzygies $\Omega_A^i(X)$ with $i \geq 1$ are also contained in \mathcal{C} .

Dually, \mathcal{C} is **coresolving** if \mathcal{C} is closed under extensions, closed under cokernels of monomorphisms, and if it contains $\text{inj}(A)$.

16.7. Co- and contravariantly finite subcategories. Let A be a finite-dimensional K -algebra.

A homomorphism $g: M \rightarrow N$ in $\text{mod}(A)$ is **right minimal** if all $h \in \text{End}_A(M)$ with $gh = g$ are automorphisms.

$$h \begin{array}{c} \hookrightarrow \\ \downarrow \\ \hookrightarrow \end{array} M \xrightarrow{f} N$$

Dually, a homomorphism $f: M \rightarrow N$ in $\text{mod}(A)$ is **left minimal** if all $h \in \text{End}_A(N)$ with $hf = f$ are automorphisms.

$$M \xrightarrow{f} N \begin{array}{c} \hookrightarrow \\ \downarrow \\ \hookrightarrow \end{array} h$$

Lemma 16.4. *Let $f: M \rightarrow N$ be in $\text{mod}(A)$. Then there exists a direct sum decomposition $M = M_1 \oplus M_2$ such that the restriction $f: M_1 \rightarrow N$ is right minimal and $f(M_2) = 0$.*

There is an obvious dual statement.

Let \mathcal{C} be a full subcategory of $\text{mod}(A)$.

A homomorphism $g: M \rightarrow N$ in $\text{mod}(A)$ is a **right \mathcal{C} -approximation** of N if $M \in \mathcal{C}$ and if

$$\text{Hom}_A(\mathcal{C}, g): \text{Hom}_A(\mathcal{C}, M) \rightarrow \text{Hom}_A(\mathcal{C}, N)$$

is surjective for all $C \in \mathcal{C}$.

$$\begin{array}{ccc} & & C \\ & \swarrow & \downarrow h \\ M & \xrightarrow{g} & N \end{array}$$

In other words, every homomorphism h from the subcategory \mathcal{C} to the module N factors through the fixed homomorphism g .

Dually, a homomorphism $f: M \rightarrow N$ in $\text{mod}(A)$ is a **left \mathcal{C} -approximation** of M if $N \in \mathcal{C}$ and if

$$\text{Hom}_A(f, \mathcal{C}): \text{Hom}_A(N, \mathcal{C}) \rightarrow \text{Hom}_A(M, \mathcal{C})$$

is surjective for all $C \in \mathcal{C}$.

$$\begin{array}{ccc} M & \xrightarrow{f} & N \\ \downarrow h & & \swarrow \\ & & C \end{array}$$

In other words, every homomorphism h from M to the subcategory \mathcal{C} factors through the fixed homomorphism f .

A right (resp. left) \mathcal{C} -approximation is called **minimal** if it is right minimal (resp. left minimal).

Minimal approximations are unique up to isomorphism.

Assume now that \mathcal{C} is closed under isomorphism and under direct summands.

Then \mathcal{C} is **covariantly finite** if every $N \in \text{mod}(A)$ has a right \mathcal{C} -approximation.

Dually, \mathcal{C} is **contravariantly finite** if every $M \in \text{mod}(A)$ has a left \mathcal{C} -approximation.

One calls \mathcal{C} **functorially finite** if it is both covariantly finite and contravariantly finite.

These types of subcategories allow to develop Auslander-Reiten theory for subcategories.

LITERATURE – CO- AND CONTRAVARIANTLY FINITE SUBCATEGORIES

- [AR75] M. Auslander, I. Reiten, *Applications of contravariantly finite subcategories*. Adv. Math. 86 (1991), no. 1, 111–152.
 [AS81] M. Auslander, S. Smalø, *Almost split sequences in subcategories*. J. Algebra 69 (1981), no. 2, 426–454.
 [EMM10] K. Erdmann, D. Madsen, V. Miemietz, *On Auslander-Reiten translates in functorially finite subcategories and applications*. Colloq. Math. 119 (2010), no. 1, 51–77.

16.8. **Torsion pairs.** Let \mathcal{A} be an abelian category.

A pair $(\mathcal{T}, \mathcal{F})$ of full subcategories of \mathcal{A} is a **torsion pair** for \mathcal{A} if the following hold:

- (i) $\text{Hom}_{\mathcal{A}}(\mathcal{T}, \mathcal{F}) = 0$.
- (ii) If $X \in \mathcal{A}$ with $\text{Hom}_{\mathcal{A}}(X, \mathcal{F}) = 0$, then $X \in \mathcal{T}$.
- (iii) If $Y \in \mathcal{A}$ with $\text{Hom}_{\mathcal{A}}(\mathcal{T}, Y) = 0$, then $Y \in \mathcal{F}$.

Given a torsion pair $(\mathcal{T}, \mathcal{F})$, one calls \mathcal{T} a **torsion class** and \mathcal{F} a **torsion-free class** in \mathcal{A} .

Proposition 16.5. (i) *A full subcategory \mathcal{T} of \mathcal{A} is a torsion class if and only if \mathcal{T} is closed under factors objects and extensions.*
 (ii) *A full subcategory \mathcal{F} of \mathcal{A} is a torsion-free class if and only if \mathcal{F} is closed under subobjects and extensions.*

Proposition 16.6. *Let $(\mathcal{T}, \mathcal{F})$ be a torsion pair for \mathcal{A} . For each $M \in \mathcal{A}$ there is a unique subobject tM of M such that $tM \in \mathcal{T}$ and $M/tM \in \mathcal{F}$.*

Clearly, tM is the largest torsion subobject of M .

We consider now the special case $\mathcal{A} = \text{mod}(A)$ where A is a finite-dimensional algebra.

Let $\text{tors}(A)$ (resp. $\text{torsfr}(A)$) be the set of torsion classes (resp. torsion-free classes in $\text{mod}(A)$). Let $\text{ff-tors}(A)$ (resp. $\text{ff-torsfr}(A)$) be the set of functorially finite torsion classes (resp. functorially finite torsion-free classes in $\text{mod}(A)$).

For a full subcategory \mathcal{C} of $\text{mod}(A)$ let $\mathcal{C}^\perp := \{X \in \text{mod}(A) \mid \text{Hom}_A(\mathcal{C}, X) = 0\}$ and ${}^\perp\mathcal{C} := \{X \in \text{mod}(A) \mid \text{Hom}_A(X, \mathcal{C}) = 0\}$. We get bijections

$$\text{tors}(A) \begin{array}{c} \xrightarrow{(-)^\perp} \\ \cong \\ \xleftarrow{{}^\perp(-)} \end{array} \text{torsfr}(A)$$

which are inverses of each other. These restrict to bijections

$$\text{ff-tors}(A) \begin{array}{c} \xrightarrow{(-)^\perp} \\ \cong \\ \xleftarrow{{}^\perp(-)} \end{array} \text{ff-torsfr}(A)$$

For a full subcategory \mathcal{C} of $\text{mod}(A)$ let $\mathcal{T}(\mathcal{C})$ (resp. $\mathcal{F}(\mathcal{C})$) be the smallest torsion class (resp. torsion-free class) in $\text{mod}(A)$ which contains \mathcal{C} .

For a wide subcategory \mathcal{C} of $\text{mod}(A)$ we have

$$\mathcal{T}(\mathcal{C}) \cap \mathcal{F}(\mathcal{C}) = \mathcal{C}.$$

For a torsion class \mathcal{T} in $\text{mod}(A)$ let

$$\alpha_{\mathcal{T}}(\mathcal{T}) := \{Y \in \mathcal{T} \mid \text{Ker}(f) \in \mathcal{T} \text{ for all } f \in \text{Hom}_A(X, Y) \text{ and } X \in \text{mod}(A)\}.$$

Dually, for a torsion-free class \mathcal{F} in $\text{mod}(A)$ let

$$\alpha_{\mathcal{F}}(\mathcal{F}) := \{X \in \mathcal{F} \mid \text{Cok}(f) \in \mathcal{F} \text{ for all } f \in \text{Hom}_A(X, Y) \text{ and } Y \in \text{mod}(A)\}.$$

Theorem 16.7. *For the maps*

$$\begin{array}{ccc} \text{wide}(A) & & \text{wide}(A) \\ \alpha_{\mathcal{T}} \uparrow \downarrow \mathcal{T}(-) & & \alpha_{\mathcal{F}} \uparrow \downarrow \mathcal{F}(-) \\ \text{tors}(A) & \begin{array}{c} \xrightarrow{(-)^\perp} \\ \cong \\ \xleftarrow{{}^\perp(-)} \end{array} & \text{torsfr}(A) \end{array}$$

we have $\alpha_{\mathcal{T}} \circ \mathcal{T}(-) = \text{id}$ and $\alpha_{\mathcal{F}} \circ \mathcal{F}(-) = \text{id}$.

An important class of examples of torsion pairs arises from tilting modules and partial tilting modules.

$T \in \text{mod}(A)$ is a **partial tilting module** if the following hold:

$$(T1) \quad \text{Ext}_A^1(T, T) = 0.$$

$$(T2) \quad \text{proj. dim}(T) \leq 1.$$

T is a **tilting module** if additionally the following holds:

(T3) There exists a short exact sequence

$$0 \rightarrow {}_A A \rightarrow T_0 \rightarrow T_1 \rightarrow 0$$

with $T_0, T_1 \in \text{add}(T)$.

For a partial tilting module T let

$$\mathcal{F}(T) := \{X \in \text{mod}(A) \mid \text{Hom}_A(T, X) = 0\},$$

$$\mathcal{T}(T) := \{X \in \text{mod}(A) \mid \text{Ext}_A^1(T, X) = 0\}.$$

For $M \in \text{mod}(A)$ let

$$\text{gen}(M) := \{X \in \text{mod}(A) \mid \text{there is an epimorphism } M^m \rightarrow X \text{ for some } m\},$$

$$\text{cogen}(M) := \{X \in \text{mod}(A) \mid \text{there is a monomorphism } X \rightarrow M^m \text{ for some } m\}.$$

Proposition 16.8. *Let $T \in \text{mod}(A)$ be a partial tilting module, then $(\text{gen}(T), \mathcal{F}(T))$ and $(\mathcal{T}(T), \text{cogen}(\tau_A(T)))$ are torsion pairs.*

Proposition 16.9. *Let $T \in \text{mod}(A)$ be a tilting module, then $\text{gen}(T) = \mathcal{T}(T)$ and $\text{cogen}(\tau_A(T)) = \mathcal{F}(T)$. In particular, $(\mathcal{T}(T), \mathcal{F}(T))$ is a torsion pair.*

Example: Let Q be the quiver

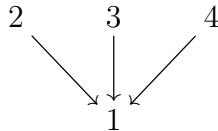

and let $A = KQ$. Let T be the indecomposable A -module with

$$\underline{\dim}(T) = \begin{matrix} 0 & 1 & 1 \\ & 1 & \end{matrix}.$$

Then T is a partial tilting module, and $(\text{gen}(T), \mathcal{F}(T))$ is a torsion pair. The AR quiver Γ_A looks as follows:

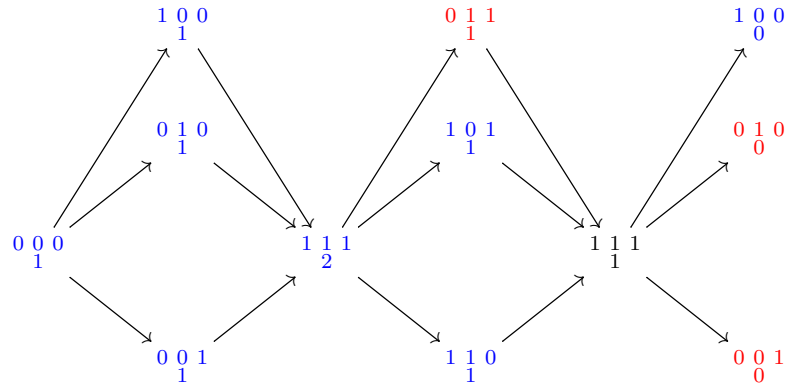

The modules in $\text{gen}(T)$ are marked in red, and the ones in $\mathcal{F}(T)$ are marked in blue.

16.9. Hierarchy of subcategories.

Proposition 16.10. *We have the following inclusions between classes of subcategories of $\text{mod}(A)$:*

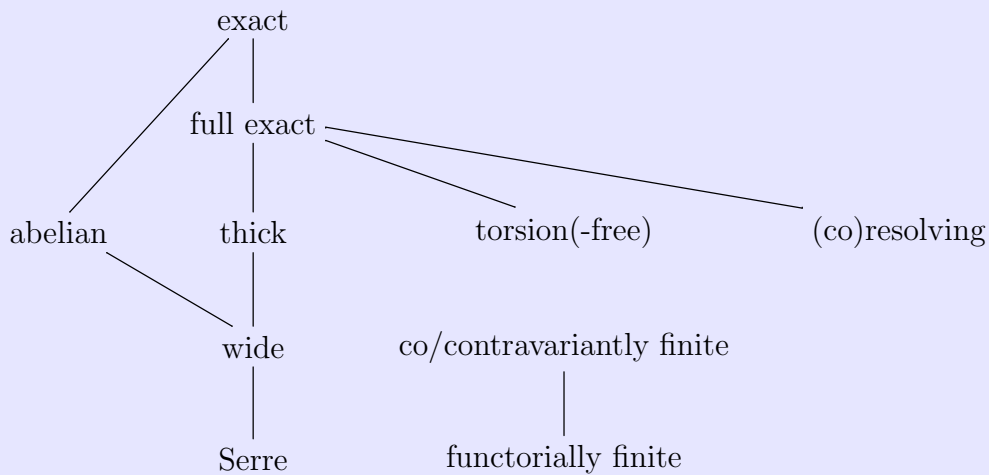

16.10. Functorially finite torsion classes.

Let A be a finite-dimensional algebra.

$X \in \text{mod}(A)$ is τ -rigid if $\text{Hom}_A(X, \tau_A(X)) = 0$.

Example: Let $X \in \text{mod}(A)$ such that $\text{Ext}_A^1(X, X) = 0$ (i.e. X is rigid) and $\text{proj. dim}(X) \leq 1$. Then X is τ -rigid.

For $X \in \text{mod}(A)$ let $\text{sd}(X)$ be the number of isomorphism classes of indecomposable direct summands of X . Let $n(A) := \text{sd}({}_A A)$.

A τ -rigid module X is a **τ -tilting module** if $\text{sd}(X) = n(A)$.

Dually, one defines τ^- -rigid and τ^- -tilting modules.

Theorem 16.11 ([AIR14, Theorem 0.2]). *Let $X \in \text{mod}(A)$ be τ -rigid. Then the following hold:*

- (i) $\text{sd}(X) \leq n(A)$.
- (ii) *There exists some $X' \in \text{mod}(A)$ such that $X \oplus X'$ is a τ -tilting module.*

Recall that $X \in \text{mod}(A)$ is **basic** if X is a direct sum of pairwise non-isomorphic indecomposable modules.

A pair (P, X) of A -modules is a **support τ -tilting pair** if X is τ -rigid, P is projective, $\text{Hom}_A(P, X) = 0$ and $\text{sd}(P) + \text{sd}(X) = n(A)$.

Such a pair is **basic** if P and X are basic.

Let $\text{s}\tau\text{-tilt}(A)$ be the set of isomorphism classes (in the obvious sense) of basic support τ -tilting pairs.

Dually, let $\text{s}\tau^-\text{-tilt}(A)$ be the set of isomorphism classes of basic support τ^- -tilting pairs.

For a torsion class \mathcal{T} in $\text{mod}(A)$, $P \in \mathcal{T}$ is **\mathcal{T} -projective** if $\text{Ext}_A^1(P, \mathcal{T}) = 0$. The torsion class \mathcal{T} has a \mathcal{T} -projective generator if and only if \mathcal{T} is functorially finite. In this case, let $P(\mathcal{T})$ denote a basic \mathcal{T} -projective generator of \mathcal{T} . (This is unique, up to isomorphism.)

For a torsion-free class \mathcal{F} in $\text{mod}(A)$, $I \in \mathcal{F}$ is **\mathcal{F} -injective** if $\text{Ext}_A^1(\mathcal{F}, I) = 0$. The torsion-free class \mathcal{F} has an \mathcal{F} -injective cogenerator if and only if \mathcal{F} is functorially finite. In this case, let $I(\mathcal{F})$ denote a basic \mathcal{F} -injective cogenerator of \mathcal{F} . (This is unique, up to isomorphism.)

A wide subcategory $\mathcal{C} \in \text{wide}(A)$ is **left finite** (resp. **right finite**) if $\mathcal{T}(\mathcal{C})$ (resp. $\mathcal{F}(\mathcal{C})$) is functorially finite.

Let $\text{lf-wide}(A)$ (resp. $\text{rf-wide}(A)$) be the set of left finite (resp. right finite) wide subcategories of $\text{mod}(A)$.

Theorem 16.12 ([MS17, Proposition 3.9], [AIR14, Theorem 0.5]). *There are bijections*

$$\begin{array}{ccc}
 \text{lf-wide}(A) & & \text{rf-wide}(A) \\
 \uparrow \downarrow & & \uparrow \downarrow \\
 \alpha_T \uparrow & & \alpha_F(-) \uparrow \\
 \mathcal{T}(-) \downarrow & & \mathcal{F}(-) \downarrow \\
 \text{ff-tors}(A) & \xrightarrow{(-)^\perp} & \text{ff-torsfr}(A) \\
 \leftarrow \cong & & \\
 \perp(-) & & \\
 \uparrow \downarrow & & \uparrow \downarrow \\
 T \mapsto \text{gen}(T) & & T \mapsto \text{cogen}(T) \\
 \mathcal{T} \mapsto P(\mathcal{T}) & & \mathcal{F} \mapsto I(\mathcal{F}) \\
 \text{s}\tau\text{-tilt}(A) & & \text{s}\tau^-\text{-tilt}(A)
 \end{array}$$

Let $\text{brick}(A)$ be the set of isomorphism classes of bricks in $\text{mod}(A)$.

A brick X is **left finite** (resp. **right finite**) if the smallest torsion class $\mathcal{T}(X)$ (resp. the smallest torsion-free class $\mathcal{F}(X)$) containing X is functorially finite.

Let $\text{lf-brick}(A)$ (resp. $\text{rf-brick}(A)$) be the set of isomorphism classes of left finite (resp. right finite) bricks.

Let $\tau\text{-rigid}(A)$ be the set of isomorphism classes of indecomposable τ -rigid A -modules.

Theorem 16.13 ([DIJ19, Theorem 4.1]). *The map*

$$\begin{aligned}
 \tau\text{-rigid}(A) &\rightarrow \text{lf-brick}(A) \\
 X &\mapsto \text{rad}_B(X)
 \end{aligned}$$

with $B := \text{End}_A(X)$ is a bijection.

The previous theorem has a dual version.

For further results in this direction we refer to [A20].

Example: Let $A = KQ/I$ where Q is the quiver

$$a \begin{array}{c} \circlearrowleft \\ \circlearrowright \end{array} 1 \longleftarrow 2$$

and I is the ideal generated by a^2 . The AR quiver Γ_A looks as follows:

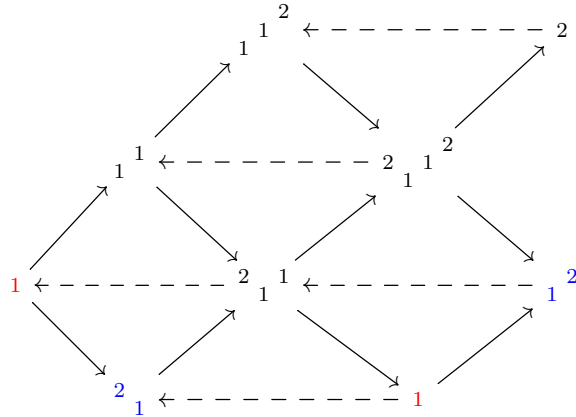

(One needs to identify the two blue and the two red modules.) Thus there are 7 indecomposable A -modules, up to isomorphism. Four of these are τ -rigid. The map

$$\tau\text{-rigid}(A) \rightarrow \text{lf-brick}(A)$$

is given by

$${}_1^1 1^2 \mapsto {}_1^1 1^2, \quad 2 \mapsto 2, \quad {}_1^1 1 \mapsto 1, \quad {}_2^1 1^2 \mapsto {}_2^1 1.$$

LITERATURE - FUNCTORIALLY FINITE TORSION CLASSES

[AIR14] T. Adachi, O. Iyama, I. Reiten, τ -tilting theory. *Compos. Math.* 150 (2014), no. 3, 415–452.
 [A20] S. Asai, *Semibricks*. *Int. Math. Res. Not. IMRN* 2020, no. 16, 4993–5054.
 [DIJ19] L. Demonet, O. Iyama, Osamu, G. Jasso, τ -tilting finite algebras, bricks, and g -vectors. *Int. Math. Res. Not. IMRN* 2019, no. 3, 852–892.
 [MS17] F. Marks, J. ovek, *Torsion classes, wide subcategories and localisations*. *Bull. Lond. Math. Soc.* 49 (2017), no. 3, 405–416.

16.11. **Chains of torsion classes and stability.** Let \mathcal{A} be a length category, and let $\text{Ob}(\mathcal{A})^\times := \text{Ob}(\mathcal{A}) \setminus \{0\}$.

Our focus lies as usual on $\mathcal{A} = \text{mod}(A)$ where A is a finite-dimensional algebra.

16.11.1. *Chains of torsion classes and slicings.* We follow [T18].

A **chain of torsion classes** in \mathcal{A} indexed by $[0, 1]$ is given by a set

$$\eta = \{\mathcal{T}_s \mid s \in [0, 1]\}$$

of torsion classes such that $\mathcal{T}_s \subseteq \mathcal{T}_r$ for all $r, s \in [0, 1]$ with $r \leq s$, $\mathcal{T}_0 = \mathcal{A}$ and $\mathcal{T}_1 = 0$.

For such a chain of torsion classes, for $s \in [0, 1]$ let \mathcal{F}_s be the full subcategory of \mathcal{A} such that $(\mathcal{T}_s, \mathcal{F}_s)$ is a torsion pair.

For $r \leq s$ we get $\mathcal{F}_r \subseteq \mathcal{F}_s$.

For $X \in \mathcal{A}$ and $s \in [0, 1]$ there is a unique subobject $t_s X$ of X such that $t_s X \in \mathcal{T}_s$ and $X/t_s X \in \mathcal{F}_s$. It follows that $t_s X$ is the largest torsion subobject of X with respect to \mathcal{T}_s .

We get $t_s X \subseteq t_r X$ for all $r \leq s$.

Let

$$\mathcal{P}_\eta := \{\mathcal{P}_\eta(r) \mid r \in [0, 1]\}$$

where

$$\mathcal{P}_\eta(r) := \begin{cases} \bigcap_{s>0} \mathcal{F}_s & \text{if } r = 0, \\ \left(\bigcap_{s<r} \mathcal{T}_s\right) \cap \left(\bigcap_{s>r} \mathcal{F}_s\right) & \text{if } r \in (0, 1), \\ \bigcap_{s<1} \mathcal{T}_s & \text{if } r = 1. \end{cases}$$

Theorem 16.14 ([T18, Theorem 1.4]). *Let $\eta = \{\mathcal{T}_s \mid s \in [0, 1]\}$ be a chain of torsion classes in \mathcal{A} . Then each $X \in \text{Ob}(\mathcal{A})^\times$ has a unique filtration*

$$0 = X_0 \subset X_1 \subset \cdots \subset X_n = X$$

such that the following hold:

- (i) For each $1 \leq i \leq n$ there exists some $r_i \in [0, 1]$ such that $X_i/X_{i-1} \in \mathcal{P}_\eta(r_i)$.
- (ii) $r_1 > r_2 > \cdots > r_n$.

The filtration in the theorem is the **Harder-Narasimhan filtration** of X .

A **slicing** of \mathcal{A} is given by a set

$$\mathcal{P} = \{\mathcal{P}(r) \mid r \in [0, 1]\}$$

of full additive subcategories $\mathcal{P}(r)$ of \mathcal{A} such that the following hold:

- (i) $\text{Hom}_{\mathcal{A}}(\mathcal{P}(r), \mathcal{P}(s)) = 0$ for all $r > s$.
- (ii) For each $X \in \text{Ob}(\mathcal{A})^\times$ there exists a filtration

$$0 = X_0 \subset X_1 \subset \cdots \subset X_n = X$$

and $r_1 > r_2 > \cdots > r_n$ in $[0, 1]$ such that

$$X_i/X_{i-1} \in \mathcal{P}(r_i)$$

for $1 \leq i \leq n$.

Theorem 16.15 ([T18, Theorem 1.6]). *Every chain η of torsion classes in \mathcal{A} indexed by $[0, 1]$ induces a slicing \mathcal{P}_η of \mathcal{A} , and every slicing of \mathcal{A} arises in this way.*

16.11.2. Maximal green sequences.

A **maximal green sequence** in \mathcal{A} is a non-refineable finite chain

$$0 = \mathcal{T}_0 \subset \mathcal{T}_1 \subset \cdots \subset \mathcal{T}_n = \mathcal{A}$$

of torsion classes in \mathcal{A} .

The torsion classes \mathcal{T}_i appearing in such a maximal green sequence are functorially finite.

Maximal green sequences do not always exist, and if they exist, they might have different lengths.

The existence (or non-existence) of maximal green sequences is an important matter and is related e.g. to the existence of good bases for Fom-Zelevinsky cluster algebras and to the construction of Donaldson-Thomas invariants for certain 3-Calabi-Yau categories.

Let now A be a finite-dimensional algebra, and let $\mathcal{A} = \text{mod}(A)$.

Theorem 16.16 ([DK20, Theorem A.3]). *There is a bijection Φ between the set of maximal green sequences in \mathcal{A} and the set of non-refinable finite sequences $([B_1], \dots, [B_n])$ of isomorphism classes of bricks in \mathcal{A} such that $\text{Hom}_{\mathcal{A}}(B_i, B_j) = 0$ for all $i < j$.*

The set $\text{tors}(A)$ of torsion classes in $\text{mod}(A)$ is a poset where the partial order is given by $\mathcal{T} \leq \mathcal{T}'$ if $\mathcal{T} \subseteq \mathcal{T}'$.

Let $\text{Hasse}(\text{tors}(A))$ be the associated Hasse quiver. Its vertices are the torsion classes in $\text{mod}(A)$, and there is an arrow $q: \mathcal{T} \rightarrow \mathcal{T}'$ provided $\mathcal{T} < \mathcal{T}'$ and for each torsion class \mathcal{T}'' with $\mathcal{T} \leq \mathcal{T}'' \leq \mathcal{T}'$ we have $\mathcal{T}'' = \mathcal{T}$ or $\mathcal{T}'' = \mathcal{T}'$. In this case, there is a unique brick $S \in \mathcal{T}'$ with $\text{Hom}_A(\mathcal{T}, S) = 0$. The arrow q receives S as a label. (The brick S might appear as a label of more than one arrow.)

Maximal green sequences in \mathcal{A} correspond to the finite paths of the form

$$0 = \mathcal{T}_0 \xrightarrow{B_1} \mathcal{T}_1 \xrightarrow{B_2} \cdots \xrightarrow{B_n} \mathcal{T}_n = \mathcal{A}$$

in the labelled quiver $\text{Hasse}(\text{tors}(A))$.

The map Φ in the theorem sends such a maximal green sequence to the tuple $([B_1], \dots, [B_n])$. Vice versa, given a non-refinable finite sequences $([B_1], \dots, [B_n])$ as in the theorem and $1 \leq i \leq n$, let $\mathcal{T}_i := \mathcal{T}(B_1, \dots, B_i)$ be the smallest torsion class containing B_1, \dots, B_i . Then

$$0 = \mathcal{T}_0 \subset \mathcal{T}_1 \subset \cdots \subset \mathcal{T}_n = \mathcal{A}$$

is a maximal green sequence.

A brick sequence $([B_1], \dots, [B_n])$ as above is also called a **maximal green sequence**.

Examples:

(i) Let Q be the quiver

$$1 \longleftarrow 2$$

and let $A = KQ$. The AR quiver Γ_A looks as follows:

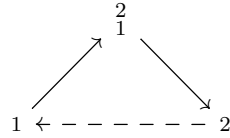

The maximal green sequences in $\text{mod}(A)$ are $(1, 2)$ and $(2, \frac{2}{1}, 1)$. The chain of torsion classes associated with the first sequence is

$$0 = \mathcal{T}_0 \xrightarrow{1} \mathcal{T}_1 = \text{add}(1) \xrightarrow{2} \mathcal{T}_2 = \text{mod}(A)$$

and the chain associated with the second sequence is

$$0 = \mathcal{T}_0 \xrightarrow{2} \mathcal{T}_1 = \text{add}(2) \xrightarrow{\frac{2}{1}} \mathcal{T}_2 = \text{add}(2 \oplus \frac{2}{1}) \xrightarrow{1} \mathcal{T}_3 = \text{mod}(A).$$

(ii) Let Q be the quiver

$$1 \rightleftarrows 2$$

and let $A = KQ$. The only maximal green sequence in $\text{mod}(A)$ is

$$(1, 2).$$

(iii) Let $A = KQ/I$ where Q is the quiver

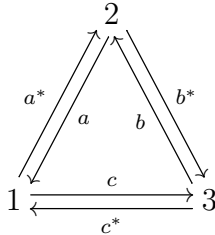

and I is generated by the relations

$$\{aa^*, a^*a, bb^*, b^*b, cc^*, c^*c\} \cup \{\text{all paths of length 3 in } Q\}.$$

Note that A is a representation-infinite string algebra. By [H21, Example 4.27], there is no maximal green sequence in $\text{mod}(A)$.

16.11.3. *Why stability?* One would like to parametrize the isomorphism classes of objects in \mathcal{A} by a space X (usually a quasi-projective variety). This is a bit too naive and usually fails. Choosing a stability function ϕ , one gets the wide subcategory $\mathcal{A}_\phi(t)$ of ϕ -semistable objects of phase t in \mathcal{A} . For the simple objects in $\mathcal{A}_\phi(t)$ (i.e. the ϕ -stable objects of phase t in \mathcal{A}) one can construct a parametrizing space $X_\phi(t)$. We will not discuss $X_\phi(t)$ in these notes. Instead we focus on the notion of directedness arising from stability functions.

16.11.4. *Looking for directedness.* In a length category, there are usually many cycles, i.e. sequences of non-zero and non-invertibles morphisms

$$X = X_0 \xrightarrow{f_1} X_1 \xrightarrow{f_2} \cdots \xrightarrow{f_n} X_n = X$$

where the X_i are indecomposable objects. Torsion pairs, chains of torsion classes, stability, Δ -filtered modules for quasi-hereditary algebras, to some extent coverings of module categories and similar concepts all have one thing in common: One tries to get rid of cycles and to obtain a situation where everything is directed, i.e. the morphisms only go in one direction. More precisely, one tries to construct full additive subcategories

$$\{\mathcal{A}(r) \mid r \in P\}$$

of \mathcal{A} where P is some totally ordered set such that $\text{Hom}_{\mathcal{A}}(\mathcal{A}(r), \mathcal{A}(s)) = 0$ for all $r > s$. Furthermore, for each non-zero object X in \mathcal{A} (or in some suitable subcategory of \mathcal{A}) there should be a filtration

$$0 = X_0 \subset X_1 \subset \cdots \subset X_n = X$$

and $r_1 > r_2 > \cdots > r_n$ in P such that $X_i/X_{i-1} \in \mathcal{P}(r_i)$ for $1 \leq i \leq n$. One would also like that this filtration is unique. The key words here are “slicings” and “Harder-Narasimhan filtrations”.

16.11.5. *Rudakov stability.* This is based on [R97]. Let P be a totally ordered set.

A map

$$\phi: \text{Ob}(\mathcal{A})^\times \rightarrow P$$

is a **stability function** if the following hold:

- (i) ϕ is constant on isomorphism classes.
- (ii) For each short exact sequence

$$0 \rightarrow X \rightarrow Y \rightarrow Z \rightarrow 0$$

of non-zero objects in \mathcal{A} , exactly one of the following holds:

- (a) $\phi(X) < \phi(Y) < \phi(Z)$.
- (b) $\phi(X) > \phi(Y) > \phi(Z)$.
- (c) $\phi(X) = \phi(Y) = \phi(Z)$.

Condition (ii) is called the **see-saw property**. For each $X \in \text{Ob}(\mathcal{A})^\times$ one calls $\phi(X)$ the **phase** of X .

$X \in \text{Ob}(\mathcal{A})^\times$ is **ϕ -semistable** if

$$\phi(U) \leq \phi(X)$$

for all non-zero subobjects U of X . Such a ϕ -semistable object X is **ϕ -stable** if the only subobject U with $\phi(U) = \phi(X)$ is X .

For each $t \in P$ let

$$\mathcal{A}_\phi(t) := \{X \in \text{Ob}(\mathcal{A})^\times \mid X \text{ is } \phi\text{-semistable and } \phi(X) = t\} \cup \{0\}.$$

Proposition 16.17. *Let $\phi: \text{Ob}(\mathcal{A})^\times \rightarrow P$ be a stability function. Then the following hold:*

- (i) $\mathcal{A}_\phi(t)$ is a wide subcategory of \mathcal{A} .
- (ii) The simple objects in $\mathcal{A}_\phi(t)$ are the ϕ -stable objects with phase t .
- (iii) $\text{Hom}_{\mathcal{A}}(\mathcal{A}_\phi(t), \mathcal{A}_\phi(s)) = 0$ for all $t > s$.

Theorem 16.18 ([BST18, Theorem 2.13]). *Let $\phi: \text{Ob}(\mathcal{A})^\times \rightarrow P$ be a stability function. Then each $X \in \text{Ob}(\mathcal{A})^\times$ has a unique filtration*

$$0 = X_0 \subset X_1 \subset \cdots \subset X_n = X$$

such that the following hold:

- (i) For each $1 \leq i \leq n$ there exists some $t_i \in P$ such that $X_i/X_{i-1} \in \mathcal{A}_\phi(t_i)$.
- (ii) $t_1 > t_2 > \cdots > t_n$.

The filtration

$$0 = X_0 \subset X_1 \subset \cdots \subset X_n = X$$

in the previous theorem is the **Harder-Narasimhan filtration** of X .

16.11.6. *Bridgeland stability.* We follow [B07, Section 2]. As before, let \mathcal{A} be a length category.

Let

$$\mathbb{H} := \{r \exp(i\pi\phi) \mid r > 0, \phi \in (0, 1]\} \subset \mathbb{C}$$

be the **upper half plane**.

Recall that $K_0(\mathcal{A})$ denotes the Grothendieck group of \mathcal{A} . For an object X in \mathcal{A} we denote the corresponding element in $K_0(\mathcal{A})$ also by X . (There won't be any confusion arising from this.)

A **stability function** for \mathcal{A} is a group homomorphism

$$Z: K_0(\mathcal{A}) \rightarrow \mathbb{C}$$

such that for each $X \in \text{Ob}(\mathcal{A})^\times$ we have $Z(X) \in \mathbb{H}$.

Note that a stability function $Z: K_0(\mathcal{A}) \rightarrow \mathbb{C}$ is completely determined by the values $Z(S)$ where S runs over the simple objects in \mathcal{A} .

For such a stability function Z , the **phase** of $X \in \text{Ob}(\mathcal{A})^\times$ is

$$\phi_Z(X) := \frac{1}{\pi} \arg(Z(X)) \in (0, 1].$$

$X \in \text{Ob}(\mathcal{A})^\times$ is **Z -semistable** if for all non-zero subobjects U of X we have

$$\phi_Z(U) \leq \phi_Z(X).$$

Such a Z -semistable object X is **Z -stable** if the only subobject U with $\phi_Z(U) = \phi_Z(X)$ is $U = X$.

Let

$$\mathcal{A}_Z(t) := \{M \in \mathcal{A} \mid M \text{ is } Z\text{-semistable and } \phi_Z(X) = t\} \cup \{0\}.$$

Proposition 16.19. *Let $Z: K_0(\mathcal{A}) \rightarrow \mathbb{C}$ be a stability function. Then*

$$\phi_Z: \text{Ob}(\mathcal{A})^\times \rightarrow (0, 1]$$

is a stability function (in the sense of Rudakov), and we have

$$\mathcal{A}_Z(t) = \mathcal{A}_{\phi_Z}(t)$$

for all $t \in (0, 1]$.

16.11.7. *King stability.* We follow [K94].

A **character** of \mathcal{A} is a group homomorphism

$$\theta: K_0(\mathcal{A}) \rightarrow \mathbb{R}.$$

$X \in \mathcal{A}$ is **θ -semistable** if $\theta(X) = 0$ and for all subobjects U of X we have $\theta(U) \leq 0$. Such a θ -semistable object X is **θ -stable** if $X \neq 0$ and the only subobjects U with $\theta(U) = 0$ are 0 and X .

Let

$$\mathcal{A}_\theta := \{X \in \mathcal{A} \mid X \text{ is } \theta\text{-semistable}\}.$$

With $P = \mathbb{R}$ the character θ gives a stability function (in the sense of Rudakov)

$$\begin{aligned} \phi_\theta: \text{Ob}(\mathcal{A})^\times &\rightarrow P \\ X &\mapsto \theta(X). \end{aligned}$$

We get

$$\mathcal{A}_\theta = \mathcal{A}_{\phi_\theta}(0).$$

To be continued...

LITERATURE - CHAINS OF TORSION CLASSES AND STABILITY

- [B07] T. Bridgeland, *Stability conditions on triangulated categories*. Ann. of Math. (2) 166 (2007), no. 2, 317–345.
- [B17] T. Bridgeland, *Scattering diagrams, Hall algebras and stability conditions*. Algebr. Geom. 4 (2017), no. 5, 523–561.
- [BT12] T. Bridgeland, V. Toledano Laredo, *Stability conditions and Stokes factors*. Invent. Math. 187 (2012), no. 1, 61–98.
- [BST18] T. Brüstle, D. Smith, H. Treffinger, *Stability Conditions and Maximal Green Sequences in Abelian Categories*. Preprint (2018), arXiv:1805.04382
- [BST19] T. Brüstle, D. Smith, H. Treffinger, *Wall and chamber structure for finite-dimensional algebras*. Adv. Math. 354 (2019), 106746, 31 pp.
- [DIRRT17] L. Demonet, O. Iyama, N. Reading, I. Reiten, H. Thomas, *Lattice theory of torsion classes*. Preprint (2017), arXiv:1711.01785
- [DK20] L. Demonet, B. Keller, *A survey on maximal green sequences*. Representation theory and beyond, 267–286, Contemp. Math., 758, Amer. Math. Soc., [Providence], RI, [2020]
- [H21] M. Hofmann, *Torsion classes, wide subcategories and maximal green sequences*. PhD thesis, University of Bonn (2021).
- [K94] A. King, *Moduli of representations of finite-dimensional algebras*. Quart. J. Math. Oxford Ser. (2) 45 (1994), no. 180, 515–530.
- [R97] A. Rudakov, *Stability for an abelian category*. J. Algebra 197 (1997), no. 1, 231–245.
- [T21] H. Thomas, *An introduction to the lattice of torsion classes*. Preprint (2021), 19 pp., arXiv:2102.08527
- [T18] H. Treffinger, *An algebraic approach to Harder-Narasimhan filtrations*. Preprint (2018), 31 pp., arXiv:1810.06322

APPENDIX A. Categories

This section is devoted to recall some fundamental notions on categories and functors. We will not always go for the most general definitions. For convenience, we define several categorical concepts only inside module categories $\text{Mod}(A)$.

A.1. Coproducts. Let \mathcal{C} be a category. An object X in \mathcal{C} is a **coproduct** of a family $(X_i)_{i \in I}$ of objects in \mathcal{C} if the following hold: There exists a family $(\iota_i: X_i \rightarrow X)_{i \in I}$ of morphisms such that for any $Y \in \text{Ob}(\mathcal{C})$ and any family $(f_i: X_i \rightarrow Y)_{i \in I}$ of morphisms there exists a unique morphism $f: X \rightarrow Y$ such that $f_i = f \circ \iota_i$ for all $i \in I$.

$$\begin{array}{ccc} X_i & \xrightarrow{\iota_i} & X \\ f_i \downarrow & \swarrow f & \\ Y & & \end{array}$$

In this case, we write

$$X = \bigoplus_{i \in I} X_i \quad \text{and} \quad f = \bigoplus_{i \in I} f_i.$$

A.2. Products. Let \mathcal{C} be a category. An object X in \mathcal{C} is a **product** of a family $(X_i)_{i \in I}$ of objects in \mathcal{C} if the following hold: There exists a family $(\pi_i: X \rightarrow X_i)_{i \in I}$ of morphisms such that for any $Y \in \text{Ob}(\mathcal{C})$ and any family $(f_i: Y \rightarrow X_i)_{i \in I}$ of morphisms there exists a unique morphism $f: Y \rightarrow X$ such that $f_i = \pi_i \circ f$ for all $i \in I$.

$$\begin{array}{ccc} & & Y \\ & \swarrow f & \downarrow \pi_i \\ X & \xrightarrow{\pi_i} & X_i \end{array}$$

In this case, we write

$$X = \prod_{i \in I} X_i \quad \text{and} \quad f = \prod_{i \in I} f_i.$$

A.3. Zero objects. Let \mathcal{C} be a category. Then $I \in \text{Ob}(\mathcal{C})$ is an **initial object** if $\mathcal{C}(I, X)$ contains exactly one morphism for all $X \in \text{Ob}(\mathcal{C})$.

Dually, $T \in \text{Ob}(\mathcal{C})$ is a **terminal object** if $\mathcal{C}(X, T)$ contains exactly one morphism for all $X \in \text{Ob}(\mathcal{C})$.

Exercise: Given two initial objects I_1 and I_2 (resp. terminal objects T_1 and T_2). Then there exists a unique isomorphism $I_1 \rightarrow I_2$ (resp. $T_1 \rightarrow T_2$).

An object in \mathcal{C} is a **zero object** if it is an initial object and a terminal object. We denote such a zero object usually by 0 .

The category \mathcal{C} is a **pointed category** if it contains a zero object.

A.4. Preadditive categories.

A category \mathcal{C} is **preadditive** if $\mathcal{C}(X, Y)$ is an abelian group for all $X, Y \in \text{Ob}(\mathcal{C})$ and if the composition maps are bilinear, i.e.

$$f \circ (g_1 + g_2) = (f \circ g_1) + (f \circ g_2)$$

and

$$(f_1 + f_2) \circ g = (f_1 \circ g) + (f_2 \circ g)$$

for all $f, f_1, f_2 \in \mathcal{C}(Y, Z)$, $g, g_1, g_2 \in \mathcal{C}(X, Y)$ and $X, Y, Z \in \text{Ob}(\mathcal{C})$.

Exercise: Let \mathcal{C} be preadditive, and let $X \in \text{Ob}(\mathcal{C})$. If $\mathcal{C}(X, X)$ consists of exactly one element, then X is a zero object.

A.5. Biproducts and additive categories.

Let \mathcal{C} be a preadditive category. An object $X \in \text{Ob}(\mathcal{C})$ is a **biproduct** of objects $X_1, \dots, X_n \in \text{Ob}(\mathcal{C})$ if the following hold: There exist morphisms

$$\pi_i: X \rightarrow X_i \quad \text{and} \quad \iota_i: X_i \rightarrow X$$

such that

$$\pi_i \circ \iota_j = \begin{cases} 1_{X_i} & \text{if } i = j, \\ 0 & \text{otherwise,} \end{cases}$$

and

$$\iota_1 \circ \pi_1 + \dots + \iota_n \circ \pi_n = 1_X.$$

In this case, we call

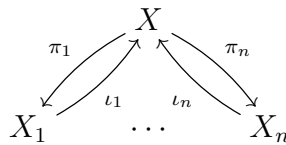

a **biproduct diagram**, and we write

$$X = X_1 \oplus \dots \oplus X_n.$$

Biproducts often coincide with the notion of finite direct sums (for example in $\text{Mod}(A)$ and in Ab). Infinite biproducts do not make sense, whereas infinite direct sums (for example in $\text{Mod}(A)$ and in Ab) are often defined.

A zero object is by definition also a biproduct.

A pointed preadditive category in which every biproduct exists is called an **additive category**.

A functor $F: \mathcal{C} \rightarrow \mathcal{D}$ between preadditive categories is an **additive functor** if the maps

$$F_{X,Y}: \mathcal{C}(X, Y) \rightarrow \mathcal{D}(F(X), F(Y))$$

are group homomorphisms for all $X, Y \in \text{Ob}(\mathcal{C})$.

Exercise: A functor between additive categories is additive if and only if it preserves all biproduct diagrams.

Exercise: All adjoint functors between additive categories are additive functors.

A.6. Ideals in additive categories. Let \mathcal{C} be an additive category.

An **ideal** \mathcal{I} in \mathcal{C} is given by a subgroup $\mathcal{I}(X, Y)$ of $\mathcal{C}(X, Y)$ for each pair $(X, Y) \in \mathcal{C} \times \mathcal{C}$ such that for all $f \in \mathcal{C}(X', X)$, $g \in \mathcal{I}(X, Y)$ and $h \in \mathcal{C}(Y, Y')$ we have

$$h \circ g \circ f \in \mathcal{I}(X', Y').$$

For an ideal \mathcal{I} in \mathcal{C} let \mathcal{C}/\mathcal{I} be the **factor category** which has the same objects as \mathcal{C} and as morphisms

$$(\mathcal{C}/\mathcal{I})(X, Y) := \mathcal{C}(X, Y)/\mathcal{I}(X, Y)$$

for $X, Y \in \mathcal{C}$.

\mathcal{C}/\mathcal{I} is an additive category.

A.7. Triangulated categories. Let \mathcal{T} be an additive category, and let

$$[-]: \mathcal{T} \rightarrow \mathcal{T}$$

be an equivalence. For objects X and morphisms f in \mathcal{T} and $n \in \mathbb{Z}$ we write $X[n]$ and $f[n]$ for $[-]^n(X)$ and $[-]^n(f)$. A diagram

$$X \xrightarrow{u} Y \xrightarrow{v} Z \xrightarrow{w} X[1]$$

of morphisms in \mathcal{T} is called a **triangle**. Such a triangle is also denoted by (u, v, w) . Two triangles (u_1, v_1, w_1) and (u_2, v_2, w_2) are **isomorphic** if there is a triple (f_1, f_2, f_3) of isomorphisms such that the diagram

$$\begin{array}{ccccccc} X_1 & \xrightarrow{u_1} & Y_1 & \xrightarrow{v_1} & Z_1 & \xrightarrow{w_1} & X_1[1] \\ \downarrow f_1 & & \downarrow f_2 & & \downarrow f_3 & & \downarrow f_1[1] \\ X_2 & \xrightarrow{u_2} & Y_2 & \xrightarrow{v_2} & Z_2 & \xrightarrow{w_2} & X_2[1] \end{array}$$

commutes.

The category \mathcal{T} together with a set of triangles which are called **distinguished triangles** is a **triangulated category** if the following hold:

- (T1) – A triangle which is isomorphic to a distinguished triangle is also distinguished.
- For each morphism $u: X \rightarrow Y$ in \mathcal{T} there exists a distinguished triangle

$$X \xrightarrow{u} Y \rightarrow Z \rightarrow X[1].$$

- The triangle

$$X \xrightarrow{1_X} X \rightarrow 0 \rightarrow X[1]$$

is distinguished for each $X \in \mathcal{T}$.

- (T2) A triangle

$$X \xrightarrow{u} Y \xrightarrow{v} Z \xrightarrow{w} X[1]$$

is distinguished if and only if

$$Y \xrightarrow{v} Z \xrightarrow{w} X[1] \xrightarrow{-u[1]} Y[1]$$

is distinguished.

- (T3) Let

$$\begin{array}{ccccccc} X_1 & \xrightarrow{u_1} & Y_1 & \xrightarrow{v_1} & Z_1 & \xrightarrow{w_1} & X[1] \\ \downarrow f_1 & & \downarrow f_2 & & & & \downarrow f_1[1] \\ X_2 & \xrightarrow{u_2} & Y_2 & \xrightarrow{v_2} & Z_2 & \xrightarrow{w_2} & X_2[1] \end{array}$$

be a diagram of morphism in \mathcal{T} such that both rows are distinguished triangles and $u_2 f_1 = f_2 u_1$. Then there is a morphism $f_3: Z_1 \rightarrow Z_2$ such that $v_2 f_2 = f_3 v_1$ and $w_2 f_3 = f_1[1] w_1$.

- (T4) Let (u_1, v_1, w_1) , (u_2, v_2, w_2) and (u_3, v_3, w_3) be distinguished triangles such that $u_3 = u_2 u_1$. Then there exists a distinguished triangle (u_4, v_4, w_4) such that the diagram

$$\begin{array}{ccccccc} X & \xrightarrow{u_1} & Y & \xrightarrow{v_1} & U & \xrightarrow{w_1} & X[1] \\ \parallel & & \downarrow u_2 & & \downarrow u_4 & & \parallel \\ X & \xrightarrow{u_3} & Z & \xrightarrow{v_3} & V & \xrightarrow{w_3} & X[1] \\ & & \downarrow v_2 & & \downarrow v_4 & & \downarrow u_1[1] \\ & & W & \xlongequal{\quad} & W & \xrightarrow{w_2} & Y[1] \\ & & \downarrow w_2 & & \downarrow w_4 & & \\ & & Y[1] & \xrightarrow{v_1[1]} & U[1] & & \end{array}$$

commutes.

Condition (T4) runs under the name **octahedral axiom**.

Triangulated categories are like tensor products: No one likes them on first sight. One needs time, patience and frequent encounters to discover their lovable properties.

As an introduction to triangulated categories we recommend the books [GM03], [N01] and [Y20] and also the survey articles [K96] and [Kr07]. The book [H88] focusses on the triangulated categories arising from finite-dimensional algebras.

Let $\mathcal{T} = (\mathcal{T}, [-])$ and $\mathcal{T}' = (\mathcal{T}', [-]')$ be triangulated categories. A **triangle functor** from \mathcal{T} to \mathcal{T}' consists of an additive functor

$$F: \mathcal{T} \rightarrow \mathcal{T}'$$

and a natural transformation

$$\alpha: F \circ [1] \rightarrow [1]' \circ F$$

such that the following hold: For each distinguished triangle

$$X \xrightarrow{u} Y \xrightarrow{v} Z \xrightarrow{w} X[1]$$

in \mathcal{T} , the diagram

$$F(X) \xrightarrow{F(u)} F(Y) \xrightarrow{F(v)} F(Z) \xrightarrow{\alpha_X \circ F(w)} F(X)[1]$$

is a distinguished triangle in \mathcal{T}' .

A **triangle equivalence** is a triangle functor which is also an equivalence.

A.8. Kernels and cokernels in preadditive categories.

Let \mathcal{C} be a preadditive category. For a morphism $f: X \rightarrow Y$ in \mathcal{C} we say that a morphism $g: U \rightarrow X$ is a **kernel** of f if the following hold:

- $f \circ g = 0$;
- If $g': U' \rightarrow X$ is a morphism with $f \circ g' = 0$, then there exists a unique morphism $g'': U' \rightarrow U$ such that $g \circ g'' = g'$.

In this case, we say that **f has a kernel**.

$$\begin{array}{ccccc} & & U' & & \\ & & \downarrow g' & & \\ U & \xrightarrow{g} & X & \xrightarrow{f} & Y \end{array}$$

Kernels are unique up to unique isomorphism.

Exercise: Figure out what this last sentence means and prove it.

For a morphism $f: X \rightarrow Y$ in \mathcal{C} we say that a morphism $g: Y \rightarrow U$ is a **cokernel** of f if the following hold:

- $g \circ f = 0$;
- If $g': Y \rightarrow U'$ is a morphism with $g' \circ f = 0$, then there exists a unique morphism $g'': U \rightarrow U'$ such that $g'' \circ g = g'$.

In this case, we say that f has a cokernel.

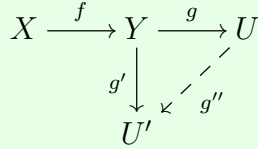

Cokernels are unique up to unique isomorphism.

A.9. Pushouts and pullbacks. Let \mathcal{C} be a category.

Let $f_1: X \rightarrow Y_1$ and $f_2: X \rightarrow Y_2$ be morphisms in \mathcal{C} . Then a pair $(g_1: Y_1 \rightarrow Z, g_2: Y_2 \rightarrow Z)$ of morphisms is called a **pushout of (f_1, f_2)** (or **fibre sum** of (f_1, f_2)) if the following hold:

- $g_1 f_1 = g_2 f_2$;
- For all morphisms $h_1: Y_1 \rightarrow Z'$ and $h_2: Y_2 \rightarrow Z'$ such that $h_1 f_1 = h_2 f_2$ there exists a unique morphism $h: Z \rightarrow Z'$ such that $h_1 = h g_1$ and $h_2 = h g_2$.

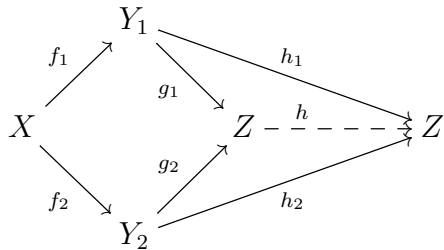

One sometimes denotes Z by $Y_1 +_Z Y_2$.

Pushouts are unique up to unique isomorphism.

Exercise: Figure out what this last sentence means and prove it.

Dually, let $g_1: Y_1 \rightarrow Z$ and $g_2: Y_2 \rightarrow Z$ be morphisms in \mathcal{C} . Then a pair $(f_1: X \rightarrow Y_1, f_2: X \rightarrow Y_2)$ is called a **pullback of (g_1, g_2)** (or **fibre product** of (f_1, f_2)) if the following hold:

- $g_1 f_1 = g_2 f_2$;
- For all morphisms $h_1: X' \rightarrow Y_1$ and $h_2: X' \rightarrow Y_2$ such that $g_1 h_1 = g_2 h_2$ there exists a unique morphism $h: X' \rightarrow X$ such that $f_1 h = h_1$ and $f_2 h = h_2$.

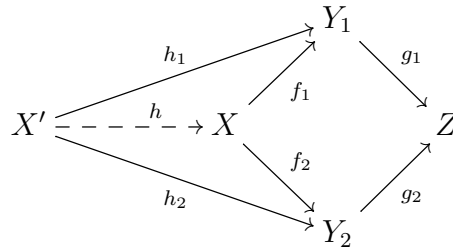

One sometimes denotes X by $Y_1 \times_Z Y_2$.

Pullbacks are unique up to unique isomorphism.

Since the pushout of a pair $(f_1: X \rightarrow Y_1, f_2: X \rightarrow Y_2)$ (resp. the pullback of a pair $(g_1: Y_1 \rightarrow Z, g_2: Y_2 \rightarrow Z)$) is unique up to unique isomorphism, we speak of **the pushout** of (f_1, f_2) (resp. **the pullback** of (g_1, g_2)).

A.10. **Exact categories.** Let \mathcal{C} be an additive category.

The category \mathcal{C} together with a class \mathcal{E} of diagrams

$$X \xrightarrow{f} Y \xrightarrow{g} Z$$

in \mathcal{C} is an **exact category** (in the sense of Quillen) if the following axioms holds:

- (E1) \mathcal{E} is closed under isomorphisms and contains the canonical (**split exact**) sequences

$$X \rightarrow X \oplus Y \rightarrow Y.$$

- (E2) Let

$$X \xrightarrow{f} Y \xrightarrow{g} Z$$

be in \mathcal{E} . Then f is called an **admissible monomorphism** and g an **admissible epimorphism**. Suppose $h: Z' \rightarrow Z$ is any morphism in \mathcal{C} , then the pullback

$$\begin{array}{ccc} Y' & \xrightarrow{g'} & Z' \\ \downarrow & & \downarrow h \\ Y & \xrightarrow{g} & Z \end{array}$$

exists, and g' is an admissible epimorphism. Dually, suppose $h: X \rightarrow X'$ is any morphism in \mathcal{C} , then the pushout

$$\begin{array}{ccc} X & \xrightarrow{f} & Y \\ h \downarrow & & \downarrow \\ X' & \xrightarrow{f'} & Y' \end{array}$$

exists, and f' is an admissible monomorphism.

- (E3) Let

$$X \xrightarrow{f} Y \xrightarrow{g} Z$$

be in \mathcal{E} . Then f is a kernel of g , and g is a cokernel of f . The composition of two admissible monomorphisms is an admissible monomorphism, and the composition of two admissible epimorphisms is an admissible epimorphism.

- (E4) Let $g: Y \rightarrow Z$ be a morphism in \mathcal{C} , which has a kernel in \mathcal{C} . Let $h: Y' \rightarrow Y$ be any morphism in \mathcal{C} such that $g \circ h: Y' \rightarrow Z$ is an admissible epimorphism. Then g is an admissible epimorphism. Dually, let $f: X \rightarrow Y$ be a morphism in \mathcal{C} , which has a cokernel in \mathcal{C} . Let $h: Y \rightarrow Y'$ be any morphism in \mathcal{C} such that $h \circ f: X \rightarrow Y'$ is an admissible monomorphism. Then f is an admissible monomorphism.

One also calls the pair $(\mathcal{C}, \mathcal{E})$ an **exact category**.

Keller (1990) proved that the axiom (E4) is redundant.

We call the diagrams in \mathcal{E} **short exact sequences** in \mathcal{C} , and we say that \mathcal{E} is an **exact structure on \mathcal{C}** . For a short exact sequence

$$X \rightarrow Y \rightarrow Z$$

we often write

$$0 \rightarrow X \rightarrow Y \rightarrow Z \rightarrow 0.$$

Let \mathcal{C} and \mathcal{D} be exact categories. An additive functor

$$F: \mathcal{C} \rightarrow \mathcal{D}$$

is an **exact functor** if for each short exact sequence

$$0 \rightarrow X \rightarrow Y \rightarrow Z \rightarrow 0$$

in \mathcal{C} , the corresponding diagram

$$0 \rightarrow F(X) \rightarrow F(Y) \rightarrow F(Z) \rightarrow 0$$

is a short exact sequence in \mathcal{D} .

The exactness of a contravariant additive functor is defined accordingly.

A full subcategory \mathcal{U} of an exact category \mathcal{C} is an **exact subcategory** if \mathcal{U} is an exact category and if the inclusion functor

$$\mathcal{U} \rightarrow \mathcal{C}$$

is exact.

Let \mathcal{C} be an exact category. A subcategory \mathcal{U} of \mathcal{C} is **closed under extensions** if for each short exact sequence

$$X \rightarrow Y \rightarrow Z$$

in \mathcal{C} with $X, Z \in \mathcal{U}$, we also have $Y \in \mathcal{U}$.

A full subcategory \mathcal{U} of an exact category \mathcal{C} is a **full exact subcategory** if $0 \in \mathcal{U}$ and if \mathcal{U} is closed under extensions.

In this case, \mathcal{U} together with the short exact sequences

$$X \rightarrow Y \rightarrow Z$$

in \mathcal{C} such that $X, Y, Z \in \mathcal{U}$ form an exact category. We say that **the exact structure on \mathcal{U} is induced by the exact structure on \mathcal{C}** .

Each full exact subcategory is an exact subcategory.

Let \mathcal{C} be an exact category, and let **Ab** be the category of abelian groups with the canonical exact structure.

An object $P \in \mathcal{C}$ is **\mathcal{C} -projective** if the functor

$$\mathcal{C}(P, -): \mathcal{C} \rightarrow \text{Ab}$$

is exact.

The category \mathcal{C} has **enough projectives** if for each object $Y \in \mathcal{C}$ there is an exact sequence

$$X \rightarrow P \rightarrow Y$$

where P is \mathcal{C} -projective. We write $\Omega(Y) := X$.

Here are the dual definitions:

An object $I \in \mathcal{C}$ is **\mathcal{C} -injective** if the contravariant functor

$$\mathcal{C}(-, I): \mathcal{C} \rightarrow \text{Ab}$$

is exact.

The category \mathcal{C} has **enough injectives** if for each object $X \in \mathcal{C}$ there is an exact sequence

$$X \rightarrow I \rightarrow Y$$

where I is \mathcal{C} -projective. We write $\Sigma(X) := Y$.

A.11. Frobenius categories.

An exact category \mathcal{F} is a **Frobenius category** if the following hold:

- (i) \mathcal{F} has enough projectives;
- (ii) \mathcal{F} has enough injectives;
- (iii) An object is \mathcal{C} -projective if and only if it is \mathcal{C} -injective.

Let \mathcal{F} be a Frobenius category. The **stable category** $\underline{\mathcal{F}}$ has by definition the same objects as \mathcal{F} . The morphism sets in $\underline{\mathcal{F}}$ are

$$\underline{\mathcal{F}}(X, Y) := \mathcal{F}(X, Y) / \mathcal{P}(X, Y)$$

where $\mathcal{P}(X, Y)$ is the subgroup of all morphisms $X \rightarrow Y$ factoring through a \mathcal{C} -projective object.

Frobenius categories form a source for triangulated categories:

Theorem A.1 (Happel [H87, H88]). *Let \mathcal{F} be a Frobenius category. Then $\underline{\mathcal{F}}$ is a triangulated category where the shift functor $[-]$ is induced by $\Sigma(-)$.*

A triangulated category \mathcal{T} is **algebraic** if there is a triangle equivalence

$$\mathcal{T} \rightarrow \underline{\mathcal{F}}$$

for some Frobenius category \mathcal{F} .

For a more detailed proof of Theorem A.1 we refer to [HZ] and [Kr07]. A discussion of some subtleties of the proof of Theorem A.1 can be found in [K07].

A.12. Preabelian and abelian categories.

An additive category \mathcal{C} is **preabelian** if every morphism has both a kernel and a cokernel.

A preabelian category is **abelian** if every monomorphism is a kernel of some morphism, and every epimorphism is a cokernel of some morphism.

Let \mathcal{C} be an abelian category. A **short exacts sequence** in \mathcal{C} is a diagram

$$X \xrightarrow{f} Y \xrightarrow{g} Z$$

such that f is a kernel of g , and g is a cokernel of f .

Let \mathcal{E} be the class of short exact sequences in an abelian category \mathcal{C} . Then $(\mathcal{C}, \mathcal{E})$ is an exact category.

For an abelian category \mathcal{A} we often write $\text{Hom}(X, Y)$ or $\text{Hom}_{\mathcal{A}}(X, Y)$ instead of $\mathcal{A}(X, Y)$.

A.13. Sub- and factor objects. Let \mathcal{C} be a category. Monomorphisms $f_1: X_1 \rightarrow X$ and $f_2: X_2 \rightarrow X$ in \mathcal{C} are **equivalent** if there exists an isomorphism $h: X_1 \rightarrow X_2$ with $f_1 = f_2 h$.

$$\begin{array}{ccc} X_1 & \xrightarrow{f_1} & X \\ h \downarrow & & \parallel \\ X_2 & \xrightarrow{f_2} & X \end{array}$$

An equivalence class of such monomorphisms is a **subobject** of X .

Analogously, epimorphisms $g_1: X \rightarrow X_1$ and $g_2: X \rightarrow X_2$ in \mathcal{C} are **equivalent** if there exists an isomorphism $h: X_1 \rightarrow X_2$ with $h g_1 = g_2$.

$$\begin{array}{ccc} X & \xrightarrow{g_1} & X_1 \\ \parallel & & \downarrow h \\ X & \xrightarrow{g_2} & X_2 \end{array}$$

An equivalence class of such epimorphisms is a **factor object** of X .

Assume now that \mathcal{C} is abelian. For each morphism $f: X \rightarrow Y$ we get a commutative diagram

$$\begin{array}{ccccc} \text{Ker}(f) & \xrightarrow{f'} & X & \xrightarrow{f} & Y & \xrightarrow{f''} & \text{Cok}(f) \\ & & \downarrow & & \uparrow & & \\ & & \text{Cok}(f') & \xrightarrow{\cong} & \text{Ker}(f'') & & \end{array}$$

The **image** $\text{Im}(f)$ of f is the subobject of Y given by the equivalence class of the monomorphism $\text{Ker}(f'') \rightarrow Y$.

A.14. **Length categories.** Let \mathcal{C} be an abelian category.

An object $X \in \mathcal{C}$ has **finite length** if there exists a chain

$$0 = X_0 \subset X_1 \subset \cdots \subset X_t = X$$

of subobjects such that X_i/X_{i-1} is simple for all $1 \leq i \leq t$. Such a chain is called a **composition series**.

The abelian category \mathcal{C} is a **length category** if each objects in \mathcal{C} has finite length and if \mathcal{C} is skeletally small.

A length category \mathcal{C} is **uniserial** if each $X \in \mathcal{C}$ has a unique composition series.

An abelian category \mathcal{C} is **noetherian** if each $X \in \mathcal{C}$ satisfies the ascending chain condition for subobjects, i.e. there is no infinite ascending chain

$$X_1 \subset X_2 \subset \cdots \subset X_t \subset \cdots$$

of subobjects of X .

A.15. **Idempotent complete categories.**

An additive category \mathcal{C} is **idempotent complete** if each endomorphism $e \in \mathcal{C}(X, X)$ with $e^2 = e$ has a kernel.

In this case, we have

$$X = \text{Ker}(e) \oplus \text{Ker}(1_X - e).$$

For each additive category \mathcal{C} there exists an idempotent complete additive category $\bar{\mathcal{C}}$ and a functor

$$F: \mathcal{C} \rightarrow \bar{\mathcal{C}}$$

which is additive, full and faithful such that each object in $\overline{\mathcal{C}}$ is isomorphic to a direct summand of an object in the image of F . One calls $\overline{\mathcal{C}}$ the **idempotent completion** of \mathcal{C} .

A.16. Krull-Remak-Schmidt categories.

An additive category \mathcal{C} is a **Krull-Remak-Schmidt category** if each object $X \in \mathcal{C}$ is isomorphic to a finite direct sum of objects with local endomorphism rings.

It follows that an analogue of the Krull-Remak-Schmidt Theorem holds in \mathcal{C} .

Examples:

- (i) Each length category is a Krull-Remak-Schmidt category, e.g. the category $\text{mod}(A)$ of finite length modules over an algebra A .
- (ii) Let K be algebraically closed, and let X be a complete K -variety. The category $\text{coh}(X)$ of coherent sheaves in X is a Krull-Remak-Schmidt category, see [A56].

A ring R is **semiperfect** if ${}_R R$ is a direct sum of indecomposable modules with local endomorphism ring.

For example, finite-dimensional algebras are semiperfect.

A proof of the following characterization of Krull-Remak-Schmidt categories can be found in [Kr15].

Proposition A.2. *For an additive category \mathcal{C} the following are equivalent:*

- (i) \mathcal{C} is a Krull-Remak-Schmidt category.
- (ii) \mathcal{C} is idempotent complete and the endomorphism ring of each object in \mathcal{C} is semiperfect.

Corollary A.3. *For a Hom-finite K -linear category \mathcal{C} the following are equivalent:*

- (i) \mathcal{C} is a Krull-Remak-Schmidt category.
- (ii) \mathcal{C} is idempotent complete.

A.17. Yoneda Lemma.

Let \mathcal{A} be a skeletally small abelian category. The **functor category** (\mathcal{A}, Ab) has the additive functors $\mathcal{A} \rightarrow \text{Ab}$ as objects and natural transformations as morphisms.

For $F, G \in \text{Ob}(\mathcal{A}, \text{Ab})$, we denote the set of morphisms $F \rightarrow G$ by (F, G) . (There are some set theoretic issues with (F, G) , but we will not discuss this.)

The functor category (\mathcal{A}, Ab) is abelian.

A diagram

$$F \rightarrow G \rightarrow H$$

in (\mathcal{A}, Ab) is **exact** if

$$F(X) \rightarrow G(X) \rightarrow H(X)$$

is exact for all $X \in \text{Ob}(\mathcal{A})$.

Lemma A.4 (Yoneda Lemma). For $X \in \text{Ob}(\mathcal{A})$ and $F \in \text{Ob}(\mathcal{A}, \text{Ab})$ there is an isomorphism

$$(\text{Hom}(X, -), F) \cong F(X)$$

defined by $\eta \mapsto \eta_X(1_X)$. This isomorphism is natural in X and F .

A functor $F \in \text{Ob}(\mathcal{A}, \text{Ab})$ is **representable** if

$$F \cong \text{Hom}(X, -)$$

for some $X \in \text{Ob}(\mathcal{A})$.

Corollary A.5 (Yoneda embedding). The contravariant functor

$$\begin{aligned} Y: \mathcal{A} &\rightarrow (\mathcal{A}, \text{Ab}) \\ X &\mapsto \text{Hom}(X, -) \end{aligned}$$

is full, faithful and left exact.

The functor Y in the previous corollary is called the **Yoneda embedding**.

A.18. Auslander functors. All results mentioned in this section are due to Auslander. Let \mathcal{A} be a skeletally small abelian category. The representable functors are projective in (\mathcal{A}, Ab) . They **generate** (\mathcal{A}, Ab) , i.e. for each $F \in (\mathcal{A}, \text{Ab})$ there exists a family $(X_i)_{i \in I}$ of objects X_i in \mathcal{A} and an exact sequence

$$\bigoplus_{i \in I} \text{Hom}(X_i, -) \rightarrow F \rightarrow 0.$$

A functor $F \in (\mathcal{A}, \text{Ab})$ is **finitely presented** if there exist $X, Y \in \text{Ob}(\mathcal{A})$ and an exact sequence

$$\text{Hom}(Y, -) \rightarrow \text{Hom}(X, -) \rightarrow F \rightarrow 0.$$

Such an exact sequence is called a **presentation** of F .

Let $\text{fp}(\mathcal{A}, \text{Ab})$ be the subcategory of finitely presented functors in (\mathcal{A}, Ab) .

$\text{fp}(\mathcal{A}, \text{Ab})$ is an abelian subcategory which is closed under extensions. It has enough projectives, and these are exactly the representable functors.

The finitely presented functors have projective dimension at most two, i.e. for each functor F in $\text{fp}(\mathcal{A}, \text{Ab})$ there are $X, Y, Z \in \text{Ob}(\mathcal{A})$ and an exact sequence

$$0 \rightarrow \text{Hom}(Z, -) \rightarrow \text{Hom}(Y, -) \rightarrow \text{Hom}(X, -) \rightarrow F \rightarrow 0.$$

Let $F \in \text{fp}(\mathcal{A}, \text{Ab})$, and let

$$\text{Hom}(Y, -) \rightarrow \text{Hom}(X, -) \rightarrow F \rightarrow 0$$

be a presentation of F . By the Yoneda Lemma, the morphism $\text{Hom}(Y, -) \rightarrow \text{Hom}(X, -)$ comes from a unique morphism $X \rightarrow Y$. We get an exact sequence

$$0 \rightarrow w(F) \rightarrow X \rightarrow Y.$$

Up to isomorphism, the object $w(F)$ does not depend on the choice of the presentation of F .

This yields an exact functor

$$w: \text{fp}(\mathcal{A}, \text{Ab}) \rightarrow \mathcal{A}.$$

The functor w is the **Auslander functor** associated with \mathcal{A} .

We have $w(\text{Hom}(X, -)) \cong X$.

Take a projective resolution

$$0 \rightarrow \text{Hom}(Z, -) \rightarrow \text{Hom}(Y, -) \rightarrow \text{Hom}(X, -) \rightarrow F \rightarrow 0.$$

Applying w yields an exact sequence

$$0 \rightarrow w(F) \rightarrow X \rightarrow Y \rightarrow Z \rightarrow 0.$$

The following are equivalent:

- (i) $w(F) = 0$.
- (ii) There exists a short exact sequence

$$0 \rightarrow X \rightarrow Y \rightarrow Z \rightarrow 0$$

in \mathcal{A} such that

$$0 \rightarrow \text{Hom}(Z, -) \rightarrow \text{Hom}(Y, -) \rightarrow \text{Hom}(X, -) \rightarrow F \rightarrow 0$$

is a projective resolution of F .

A.19. Functor categories for module categories. Let A be a finite-dimensional K -algebra. The results in this section are due to Auslander. Then each $F \in \text{fp}(\text{mod}(A), \text{Ab})$ has a minimal projective resolution.

A functor $S \in (\text{mod}(A), \text{Ab})$ is **simple** if $S \neq 0$ and if any non-zero morphism $F \rightarrow S$ in $(\text{mod}(A), \text{Ab})$ is an epimorphism.

In this case, we have $S \in \text{fp}(\text{mod}(A), \text{Ab})$.

For a simple functor $S \in (\text{mod}(A), \text{Ab})$ there is a unique indecomposable $X \in \text{mod}(A)$ such that $S(X) \neq 0$. There is a projective cover

$$\text{Hom}(X, -) \rightarrow S \rightarrow 0.$$

Let $S_X := S$.

Theorem A.6. *The map $X \mapsto S_X$ yields a bijection between the isomorphism classes of indecomposable modules in $\text{mod}(A)$ and the isomorphism classes of simple functors in $\text{fp}(\text{mod}(A), \text{Ab})$.*

If $X \in \text{mod}(A)$ is indecomposable and non-injective, then $w(S_X) = 0$. Thus there is a short exact sequence

$$0 \rightarrow X \rightarrow Y \rightarrow Z \rightarrow 0$$

in $\text{mod}(A)$ such that

$$0 \rightarrow \text{Hom}(Z, -) \rightarrow \text{Hom}(Y, -) \rightarrow \text{Hom}(X, -) \rightarrow S_X \rightarrow 0$$

is a minimal projective resolution.

This short exact sequence is the Auslander-Reiten sequence starting in X .

A.20. Categories of complexes. Let \mathcal{A} be an additive category. A **complex** over \mathcal{A} is a diagram

$$\cdots \rightarrow X_{n+1} \xrightarrow{d_{n+1}^X} X_n \xrightarrow{d_n^X} X_{n-1} \rightarrow \cdots$$

of morphisms in \mathcal{A} such that

$$d_n^X \circ d_{n+1}^X = 0$$

for all $n \in \mathbb{Z}$. For such a complex we write $X = (X_n, d_n^X)$.

The **category $\mathcal{C}(\mathcal{A})$ of complexes** over \mathcal{A} has the complexes over \mathcal{A} as objects. For complexes $X = (X_n, d_n^X)$ and $Y = (Y_n, d_n^Y)$ over \mathcal{A} a **morphism $f: X \rightarrow Y$** in $\mathcal{C}(\mathcal{A})$ is a tuple $f = (f_n)$ of morphisms in \mathcal{A} such that

$$d_n^Y \circ f_n = f_{n-1} \circ d_n^X$$

for all $n \in \mathbb{Z}$.

$$\begin{array}{ccccccc} \cdots & \longrightarrow & X_n & \xrightarrow{d_n^X} & X_{n-1} & \longrightarrow & \cdots \\ & & \downarrow f_n & & \downarrow f_{n-1} & & \\ \cdots & \longrightarrow & Y_n & \xrightarrow{d_n^Y} & Y_{n-1} & \longrightarrow & \cdots \end{array}$$

The category $\mathcal{C}(\mathcal{A})$ is again additive.

We say that a complex $X = (X_n, d_n^X)$ is **concentrated in degree d** if $X_n = 0$ for all $n \neq d$. The canonical embedding functor

$$\mathcal{A} \rightarrow \mathcal{C}(\mathcal{A})$$

sends $X \in \mathcal{A}$ to the complex

$$\cdots \rightarrow 0 \rightarrow X \rightarrow 0 \rightarrow \cdots$$

which is concentrated in degree 0.

The **category $\mathcal{C}^b(\mathcal{A})$ of bounded complexes** over \mathcal{A} is the full subcategory of $\mathcal{C}(\mathcal{A})$ of all complexes $X = (X_n, d_n^X)$ with $X_n \neq 0$ for only finitely many $n \in \mathbb{Z}$.

Let $f, g: X \rightarrow Y$ be morphisms in $\mathcal{C}(\mathcal{A})$. We say that f and g are **homotopic** and write $f \sim g$ if there is a tuple $s = (s_n)$ of morphisms $s_n: X_n \rightarrow Y_{n+1}$ in \mathcal{A} such that

$$h_n := f_n - g_n = d_{n+1}^Y \circ s_n - s_{n-1} \circ d_n^X$$

for all $n \in \mathbb{Z}$.

$$\begin{array}{ccccccccccc} \cdots & \longrightarrow & X_{n+1} & \xrightarrow{d_{n+1}^X} & X_n & \xrightarrow{d_n^X} & X_{n-1} & \longrightarrow & \cdots \\ & & \downarrow h_{n+1} & \nearrow s_n & \downarrow h_n & \nearrow s_{n-1} & \downarrow h_{n-1} & & \\ \cdots & \longrightarrow & Y_{n+1} & \xrightarrow{d_{n+1}^Y} & Y_n & \xrightarrow{d_n^Y} & Y_{n-1} & \longrightarrow & \cdots \end{array}$$

A morphism $f: X \rightarrow Y$ in $\mathcal{C}(\mathcal{A})$ is a **homotopy equivalence** if there is a morphism $g: Y \rightarrow X$ in $\mathcal{C}(\mathcal{A})$ with

$$g \circ f \sim 1_X \quad \text{and} \quad f \circ g \sim 1_Y.$$

Let \mathcal{A} be abelian. For $X = (X_n, d_n^X)$ and $n \in \mathbb{Z}$ let

$$H_n(X) := \text{Ker}(d_n^X) / \text{Im}(d_{n+1}^X)$$

be the **n th homology group** of X .

There is an obvious functor

$$H_n(-): \mathcal{C}(\mathcal{A}) \rightarrow \text{Ab}$$

which sends a complex X to $H_n(X)$.

A morphism $f: X \rightarrow Y$ in $\mathcal{C}(\mathcal{A})$ is a **quasi-isomorphism** if

$$H_n(f): H_n(X) \rightarrow H_n(Y)$$

is an isomorphism for all $n \in \mathbb{Z}$.

Proposition A.7. *Let \mathcal{A} be abelian. Then the following hold:*

(i) *For morphisms $f, g: X \rightarrow Y$ in $\mathcal{C}(\mathcal{A})$ with $f \sim g$ we have*

$$H_n(f) = H_n(g): H_n(X) \rightarrow H_n(Y)$$

for all $n \in \mathbb{Z}$.

(ii) *If a morphism $f: X \rightarrow Y$ in $\mathcal{C}(\mathcal{A})$ is a homotopy equivalence, then f is a quasi-isomorphism.*

We define the **shift functor**

$$[-]: \mathcal{C}(\mathcal{A}) \rightarrow \mathcal{C}(\mathcal{A})$$

as follows: For a complex $X = (X_n, d_n^X)$ let

$$[-](X) := X[1] := (Y_n, d_n^Y)$$

where $Y_n := X_{n-1}$ and $d_n^Y := -d_{n-1}^X$. For a morphism $f = (f_n)$ of complexes set

$$[-](f) := f[1] := (g_n)$$

where $g_n := f_{n-1}$. The functor $[-]$ is an isomorphism of categories.

A.21. Homotopy categories. Let X and Y be complexes in $\mathcal{C} := \mathcal{C}(\mathcal{A})$. Let $\mathcal{I}(X, Y)$ be the morphisms $f \in \mathcal{C}(X, Y)$ with $f \sim 0$. Then $(X, Y) \mapsto \mathcal{I}(X, Y)$ defines an ideal $\mathcal{I}(\mathcal{A})$ in $\mathcal{C}(\mathcal{A})$.

Let

$$\mathcal{K} := \mathcal{K}(\mathcal{A}) := \mathcal{C}(\mathcal{A}) / \mathcal{I}(\mathcal{A})$$

be the **homotopy category** of \mathcal{A} . Thus the objects in $\mathcal{K}(\mathcal{A})$ are the same as the objects in $\mathcal{C}(\mathcal{A})$. For objects X and Y we have $\mathcal{K}(X, Y) := \mathcal{C}(X, Y) / \mathcal{I}(X, Y)$.

The **bounded homotopy category** $\mathcal{K}^b(\mathcal{A})$ is the full subcategory of $\mathcal{K}(\mathcal{A})$ of all complexes $X \in \mathcal{C}^b(\mathcal{A})$.

Let

$$F: \mathcal{C}(\mathcal{A}) \rightarrow \mathcal{K}(\mathcal{A})$$

be the obvious canonical functor.

Proposition A.8. *For a morphism f in $\mathcal{C}(\mathcal{A})$ the following hold:*

- (i) $F(f) = 0$ if and only if $f \sim 0$.
- (ii) $F(f)$ is an isomorphism if and only if f is a homotopy equivalence.

For a morphism $f: X \rightarrow Y$ in $\mathcal{C}(\mathcal{A})$ we construct a **standard triangle**

$$X \xrightarrow{f} Y \xrightarrow{\alpha(f)} M(f) \xrightarrow{\beta(f)} X[1]$$

where for $n \in \mathbb{Z}$ we have

$$\begin{aligned} M(f)_n &:= X_{n-1} \oplus Y_n, & d_n^{M(f)} &:= \begin{pmatrix} -d_{n-1}^X & 0 \\ f_{n-1} & d_n^Y \end{pmatrix}, \\ \alpha(f)_n &:= \begin{pmatrix} 0 \\ 1_{Y_n} \end{pmatrix}, & \beta(f)_n &:= (1_{X_{n-1}} \quad 0). \end{aligned}$$

By definition, a diagram

$$X \rightarrow Y \rightarrow Z \rightarrow X[1]$$

in $\mathcal{K}(\mathcal{A})$ is a **distinguished triangle** if it is isomorphic (in $\mathcal{K}(\mathcal{A})$) to a standard triangle. With this set of distinguished triangles we get the following:

Theorem A.9. $\mathcal{K}(\mathcal{A})$ is a triangulated category.

A.22. Derived categories.

Theorem A.10. *Let \mathcal{A} be an abelian category. Then there exists a category $\mathcal{D}(\mathcal{A})$ and a functor*

$$L: \mathcal{K}(\mathcal{A}) \rightarrow \mathcal{D}(\mathcal{A})$$

such that the following hold:

- (i) *L maps quasi-isomorphism to isomorphism.*
- (ii) *Let $F: \mathcal{K}(\mathcal{A}) \rightarrow \mathcal{D}$ be a functor such that F maps quasi-isomorphisms to isomorphisms. Then there exists a unique functor $G: \mathcal{D}(\mathcal{A}) \rightarrow \mathcal{D}$ such that $GL = F$.*

$$\begin{array}{ccc} \mathcal{K}(\mathcal{A}) & \xrightarrow{L} & \mathcal{D}(\mathcal{A}) \\ F \downarrow & \swarrow G & \\ \mathcal{D} & & \end{array}$$

Here “L” stands for *localization functor*.

The category $\mathcal{D}(\mathcal{A})$ is the **derived category** of \mathcal{A} .

Let us now construct $\mathcal{D}(\mathcal{A})$. The objects in $\mathcal{D}(\mathcal{A})$ are the same as the objects in $\mathcal{K}(\mathcal{A})$. For each quasi-isomorphisms q in $\mathcal{K}(\mathcal{A})$ we introduce a formal variable q^{-1} .

Consider a diagram

$$\begin{array}{ccccccc} & & X_1 & & X_2 & & \cdots & & X_r & & \\ & q_1 \swarrow & & f_1 \searrow & q_2 \swarrow & & f_2 \searrow & \cdots & q_r \swarrow & & f_r \searrow \\ Y_0 & & & Y_1 & & Y_2 & \cdots & & Y_{r-1} & & Y_r \end{array}$$

with $q_i: X_i \rightarrow Y_{i-1}$ a quasi-isomorphism and $f_i: X_i \rightarrow Y_i$ a morphism for $1 \leq i \leq r$. We write this as a tuple

$$(f_r, q_r^{-1}, \dots, f_2, q_2^{-1}, f_1, q_1^{-1}): Y_0 \rightarrow Y_r.$$

Some of the q_i or f_i are identity morphisms, and then are deleted from this tuple. If $X = Y_0 = Y_r$, then the empty tuple $()$ stands for the identity morphism 1_X .

Two such tuples $Y_0 \rightarrow Y_r$ are **equivalent** if one can be obtained from the other by a finite sequence of the following operations:

- (i) Replace $(\dots, f_i, f_{i-1}, \dots)$ by $(\dots, f_i f_{i-1}, \dots)$.
- (ii) Replace $(\dots, q_i^{-1}, q_{i-1}^{-1}, \dots)$ by $(\dots, (q_{i-1} q_i)^{-1}, \dots)$.
- (iii) If $f_i = q_i$, replace $(\dots, f_i, q_i^{-1}, \dots)$ by $(\dots, 1_{Y_i}, \dots)$. If $f_{i-1} = q_i$, replace $(\dots, q_i^{-1}, f_{i-1}, \dots)$ by $(\dots, 1_{X_i}, \dots)$.

There are some set theoretical issues here, but they have been taken care of by the experts, see for example the short discussion on this in Neeman’s book [N01].

The **morphisms** $f: X \rightarrow Y$ in $\mathcal{D}(\mathcal{A})$ are by definition equivalence classes of tuples

$$(f_r, q_r^{-1}, \dots, f_2, q_2^{-1}, f_1, q_1^{-1}): X \rightarrow Y$$

The composition is defined by the obvious concatenation of tuples.

By definition, a diagram

$$X \rightarrow Y \rightarrow Z \rightarrow X[1]$$

in $\mathcal{D}(\mathcal{A})$ is a **distinguished triangle** if it is isomorphic (in $\mathcal{D}(\mathcal{A})$) to a standard triangle. With this set of distinguished triangles we get the following:

Theorem A.11. $\mathcal{D}(\mathcal{A})$ is a triangulated category.

One can formalize this and gets that the derived category $\mathcal{D}(\mathcal{A})$ is a *localization* of the triangulated category $\mathcal{K}(\mathcal{A})$ (and is therefore also a triangulated category).

Using the canonical functors

$$\mathcal{A} \rightarrow \mathcal{C}(\mathcal{A}) \rightarrow \mathcal{K}(\mathcal{A}) \rightarrow \mathcal{D}(\mathcal{A})$$

we can see \mathcal{A} as a subcategory of $\mathcal{D}(\mathcal{A})$.

For $X, Y \in \mathcal{A}$ we get

$$\mathcal{D}(\mathcal{A})(X, Y[n]) \cong \text{Ext}_{\mathcal{A}}^n(X, Y)$$

for all $n \geq 0$.

The **bounded derived category** $\mathcal{D}^b(\mathcal{A})$ is the full subcategory of $\mathcal{D}(\mathcal{A})$ of all complexes $X \in \mathcal{C}^b(\mathcal{A})$.

A.23. K -categories.

A category \mathcal{C} is a **K -category** if $\mathcal{C}(X, Y)$ is a K -vector space for all $X, Y \in \mathcal{C}$ and if the composition

$$\begin{aligned} \mathcal{C}(X, Y) \times \mathcal{C}(Y, Z) &\rightarrow \mathcal{C}(X, Z) \\ (f, g) &\mapsto g \circ f \end{aligned}$$

is K -bilinear for all $X, Y, Z \in \mathcal{C}$.

A functor $F: \mathcal{C} \rightarrow \mathcal{D}$ between K -categories is **K -linear** if

$$F_{X,Y}: \mathcal{C}(X, Y) \rightarrow \mathcal{D}(X, Y)$$

is K -linear for all $X, Y \in \mathcal{C}$.

Analogously one defines a **K -linear contravariant functor**.

If not mentioned otherwise, we always assume that a (covariant or contravariant) functor between K -categories is K -linear.

An additive K -category is called a **K -linear category**.

A.24. dg categories.

Let \mathcal{C} be a preadditive category. Then \mathcal{C} is a **differential graded category** (or **dg category** for short) if the following hold: For each pair (X, Y) of objects we have a direct sum decomposition

$$\mathrm{Hom}_{\mathcal{C}}(X, Y) = \bigoplus_{n \in \mathbb{Z}} \mathrm{Hom}_n(X, Y)$$

of abelian groups and a **differential d on $\mathrm{Hom}(X, Y)$** which consists of morphisms

$$d_n: \mathrm{Hom}_n(X, Y) \rightarrow \mathrm{Hom}_{n+1}(X, Y)$$

such that $d_{n+1}d_n = 0$ for all $n \in \mathbb{Z}$. Thus $\mathrm{Hom}_{\mathcal{C}}(X, Y)$ can be seen as a cochain complex. One also demands that $d(1_X) = 0$ for all X , and that the composition

$$\mathrm{Hom}_{\mathcal{C}}(X, Y) \otimes \mathrm{Hom}_{\mathcal{C}}(Y, Z) \rightarrow \mathrm{Hom}_{\mathcal{C}}(X, Z)$$

is a map of complexes for all objects X, Y, Z .

A **dg K -category** is a K -category \mathcal{C} which is a dg category as above such that the $\mathrm{Hom}_n(X, Y)$ are subspaces, the maps d_n are K -linear.

A dg K -category with a single object is nothing else than a dg algebra.

(Recall that by an *algebra* we always mean a K -algebra.)

For an excellent introduction to dg categories we refer to [J21].

LITERATURE – CATEGORIES

- [A56] M. Atiyah, *On the Krull-Schmidt theorem with application to sheaves*. Bull. Soc. Math. France 84 (1956), 307–317.
- [A10] S. Awodey, *Category Theory*. Second edition. Oxford Logic Guides, 52. Oxford University Press, Oxford, 2010. xvi+311 pp.
- [B94] F. Borceux, *Handbook of categorical algebra. 1. Basic category theory*. Encyclopedia of Mathematics and its Applications, 50. Cambridge University Press, Cambridge, 1994. xvi+345 pp.
- [GM03] S. Gelfand, Y. Manin, *Methods of homological algebra*. Second edition. Springer Monographs in Mathematics. Springer-Verlag, Berlin, 2003. xx+372 pp.
- [H87] D. Happel, *On the derived category of a finite-dimensional algebra*. Comment. Math. Helv. 62 (1987), no. 3, 339–389.

- [H88] D. Happel, *Triangulated categories in the representation theory of finite-dimensional algebras*. London Mathematical Society Lecture Note Series, 119. Cambridge University Press, Cambridge, 1988. x+208 pp.
- [HZ] C. Holdaway, K. Zatloukal, *The stable category of a Frobenius category is triangulated*. Note in the www.
- [J21] G. Jasso, *DG Categories*. Lecture notes (2021).
- [K96] B. Keller, *Derived categories and their uses*. Handbook of algebra, Vol. 1, 671–701, Handb. Algebr., 1, Elsevier/North-Holland, Amsterdam, 1996.
- [Kr07] H. Krause, *Derived categories, resolutions, and Brown representability*. Interactions between homotopy theory and algebra, 101–139, Contemp. Math., 436, Amer. Math. Soc., Providence, RI, 2007.
- [Kr15] H. Krause, *Krull-Schmidt categories and projective covers*. Expo. Math. 33 (2015), no. 4, 535–549.
- [K07] M. Künzer, *Heller triangulated categories*. Homology Homotopy Appl. 9 (2007), no. 2, 233–320.
- [L14] T. Leinster, *Basic category theory*. Cambridge Studies in Advanced Mathematics, 143. Cambridge University Press, Cambridge, 2014. viii+183 pp.
- [ML98] S. Mac Lane, *Categories for the working mathematician*. Second edition. Graduate Texts in Mathematics, 5. Springer-Verlag, New York, 1998. xii+314 pp.
- [N01] A. Neeman, *Triangulated categories*. Annals of Mathematics Studies, 148. Princeton University Press, Princeton, NJ, 2001. viii+449 pp.
- [Y20] A. Yekutieli, *Derived categories*. Cambridge Studies in Advanced Mathematics, 183. Cambridge University Press, Cambridge, 2020. xi+607 pp. IS

APPENDIX B. Books and survey articles

BOOKS ON THE REPRESENTATION THEORY OF FINITE-DIMENSIONAL ALGEBRAS

[More comments to be added...](#)

- [AC20] I. Assem, F. Coelho, *Basic representation theory of algebras*. Graduate Texts in Mathematics, 283. Springer, Cham, 2018. x+311 pp.
- [ASS06] I. Assem, D. Simson, A. Skowroński, *Elements of the representation theory of associative algebras. Vol. 1. Techniques of representation theory*. London Mathematical Society Student Texts, 65. Cambridge University Press, Cambridge, 2006. x+458 pp.
- [ARS97] M. Auslander, I. Reiten, S. Smalø, *Representation theory of Artin algebras*. Corrected reprint of the 1995 original. Cambridge Studies in Advanced Mathematics, 36. Cambridge University Press, Cambridge, 1997. xiv+425 pp.
- [B15] M. Barot, *Introduction to the representation theory of algebras*. Springer, Cham, 2015. x+179 pp.
- [Be98a] D. Benson, *Representations and cohomology. I. Basic representation theory of finite groups and associative algebras*. Second edition. Cambridge Studies in Advanced Mathematics, 30. Cambridge University Press, Cambridge, 1998. xii+246 pp.
- [Be98b] D. Benson, *Representations and cohomology. II. Cohomology of groups and modules*. Second edition. Cambridge Studies in Advanced Mathematics, 31. Cambridge University Press, Cambridge, 1998. xii+279 pp.
- [DW17] H. Derksen, J. Weyman, *An introduction to quiver representations*. Graduate Studies in Mathematics, 184. American Mathematical Society, Providence, RI, 2017. x+334 pp.
- [DK94] Drozd, Yuriy A.; Kirichenko, Vladimir V. *Finite-dimensional algebras*. Translated from the 1980 Russian original and with an appendix by Vlastimil Dlab. Springer-Verlag, Berlin, 1994. xiv+249 pp. I
- [EH18] K. Erdmann, T. Holm, *Algebras and representation theory*. Springer Undergraduate Mathematics Series. Springer, Cham, 2018. ix+298 pp.
- [GR97] P. Gabriel, A. Roiter, *Representations of finite-dimensional algebras*. Translated from the Russian. With a chapter by B. Keller. Reprint of the 1992 English translation. Springer-Verlag, Berlin, 1997. iv+177 pp.
- [H88] D. Happel, *Triangulated categories in the representation theory of finite-dimensional algebras*. London Mathematical Society Lecture Note Series, 119. Cambridge University Press, Cambridge, 1988. x+208 pp.
- [KZ98] S. König, A. Zimmermann, *Derived equivalences for group rings*. With contributions by Bernhard Keller, Markus Linckelmann, Jeremy Rickard and Raphaël Rouquier. Lecture Notes in Mathematics, 1685. Springer-Verlag, Berlin, 1998. x+246 pp.
- [P82] R. Pierce, *Associative algebras*. Graduate Texts in Mathematics, 88. Studies in the History of Modern Science, 9. Springer-Verlag, New York-Berlin, 1982. xii+436 pp.
- [Ri84] C.M. Ringel, *Tame algebras and integral quadratic forms*. Lecture Notes in Mathematics, 1099. Springer-Verlag, Berlin, 1984. xiii+376 pp.
(A milestone. The first text book on the representation theory of finite-dimensional algebras. Some parts are not easy read.)
- [S14] R. Schiffler, *Quiver representations*. CMS Books in Mathematics/Ouvrages de Mathématiques de la SMC. Springer, Cham, 2014. xii+230 pp.
- [SS07a] D. Simson, A. Skowroński, *Elements of the representation theory of associative algebras. Vol. 2. Tubes and concealed algebras of Euclidean type*. London Mathematical Society Student Texts, 71. Cambridge University Press, Cambridge, 2007. xii+308 pp.
- [SS07b] D. Simson, A. Skowroński, *Elements of the representation theory of associative algebras. Vol. 3. Representation-infinite tilted algebras*. London Mathematical Society Student Texts, 72. Cambridge University Press, Cambridge, 2007. xii+456 pp.
- [SY11] A. Skowroński, K. Yamagata, *Frobenius algebras. I. Basic representation theory*. EMS Textbooks in Mathematics. European Mathematical Society (EMS), Zürich, 2011. xii+650 pp.

- [SY17] A. Skowroński, K. Yamagata, *Frobenius algebras. II. Tilted and Hochschild extension algebras*. EMS Textbooks in Mathematics. European Mathematical Society (EMS), Zrich, 2017. x+619 pp.
- [Z14] A. Zimmermann, *Representation theory. A homological algebra point of view*. Algebra and Applications, 19. Springer, Cham, 2014. xx+707 pp.

LECTURE NOTES AND SURVEY ARTICLES

To be expanded...

- [CB19] W. Crawley-Boevey, *Noncommutative Algebra 1*. Lecture notes, 101 pp., Summer Semester 2019, Bielefeld University.
- [CB20] W. Crawley-Boevey, *Noncommutative Algebra 2: Representations of finite-dimensional algebras*. Lecture notes, 104 pp., Winter Semester 2019/20, Bielefeld University.
- [CB20b] W. Crawley-Boevey, *Noncommutative Algebra 3: Geometric methods for representations of algebras*. Lecture notes, 95 pp., Summer Semester 2020, Bielefeld University.
- [RSch20] C. Ringel, J. Schröer, *Representation theory of algebras I: Foundations*. Lecture notes.
- [RSch21] C. Ringel, J. Schröer, *Representation theory of algebras II: Homological algebra and homological conjectures*. Lecture notes.
- [RSch21] C. Ringel, J. Schröer, *Representation theory of algebras III: Auslander-Reiten theory*. Lecture notes.

BOOKS ON HOMOLOGICAL ALGEBRA

- [CE56] H. Cartan, S. Eilenberg, *Homological algebra*. With an appendix by David A. Buchsbaum. Reprint of the 1956 original. Princeton Landmarks in Mathematics. Princeton University Press, Princeton, NJ, 1999. xvi+390 pp.
- [EJ11a] E. Enochs, O. Jenda, *Relative homological algebra. Volume 1*. Second revised and extended edition. de Gruyter Expositions in Mathematics, 30. Walter de Gruyter GmbH & Co. KG, Berlin, 2011. xiv+359 pp.
- [EJ11b] E. Enochs, O. Jenda, *Relative homological algebra. Volume 2*. de Gruyter Expositions in Mathematics, 54. Walter de Gruyter GmbH & Co. KG, Berlin, 2011. xii+96 pp.
- [GM03] S. Gelfand, Y. Manin, *Methods of homological algebra*. Second edition. Springer Monographs in Mathematics. Springer-Verlag, Berlin, 2003. xx+372 pp.
- [HSt97] P.J. Hilton, U. Stammbach, *A course in homological algebra*. Second edition. Graduate Texts in Mathematics, 4. Springer-Verlag, New York, 1997. xii+364 pp.
- [L99] T.Y. Lam, *Lectures on modules and rings*. Graduate Texts in Mathematics, 189. Springer-Verlag, New York, 1999. xxiv+557 pp.
- [ML75] S. Mac Lane, *Homology*. Reprint of the 1975 edition. Classics in Mathematics. Springer-Verlag, Berlin, 1995. x+422 pp.
- [N60] D. Northcott, *An introduction to homological algebra*. Reprint of the 1960 original. Cambridge University Press, Cambridge, 2008. xii+282 pp.
- [R09] J. Rotman, *An introduction to homological algebra*. Second edition. Universitext. Springer, New York, 2009. xiv+709 pp.
- [W94] C. Weibel, *An introduction to homological algebra*. Cambridge Studies in Advanced Mathematics, 38. Cambridge University Press, Cambridge, 1994. xiv+450 pp.
- [W99] C. Weibel, *History of Homological Algebra*. History of topology, 797–836, North-Holland, Amsterdam, 1999.

INDEX

- 2-acyclic quiver, 121
- A -dual of a module, 149
- K -algebra, 146
- K -bialgebra, 146
- K -category, 356
- K -coalgebra, 146
- K -linear category, 357
- K -linear functor, 356
- P -maximal algebra, 205
- P -minimal algebra, 204
- P -space, 176
- Z -semistable, 334
- Z -stable, 334
- Ω -periodic module, 143
- $\text{Irr}_A(X, Y)$, 264
- ϕ -semistable, 332
- ϕ -stable, 332
- $\text{rad}_A(X, Y)$, 73, 263
- τ -periodic module, 143
- τ -tame algebra, 38
- τ -tilting finite algebra, 111, 304
- θ -semistable, 334
- θ -stable, 334
- g -vector of a module, 301
- g -vector of an irreducible component, 301
- n -Auslander algebra, 107
- n -Calabi-Yau tilted algebra, 117
- n -Iwanaga-Gorenstein algebra, 151
- n -cluster-tilting module, 106, 109
- n -cluster-tilting object, 117
- n -hereditary algebra, 110
- n -representation-finite algebra, 109, 110
- $\text{gp}(A)$, 149

- abelian category, 346
- abelian subcategory, 316
- accessible module, 27
- acyclic quiver, 53, 121
- additive category, 337
- additive functor, 338
- additive generator, 105
- additive invariant of irreducible components, 305
- algebraic triangulated category, 346
- almost complete tilting module, 250
- almost hereditary algebra, 98
- Amiot cluster category, 193
- Auslander algebra, 105
- Auslander-Reiten quiver, 266
- Auslander-Reiten sequence, 253
- Auslander-Reiten translation, 257

- Beilinson algebra, 110

- big finitistic dimension, 240
- bimodule of irreducible maps, 264
- biproduct diagram, 337
- biproduct in a category, 337
- bisection of a quiver, 160
- biserial algebra, 159
- biserial quiver, 160
- block, 232
- branch extension algebra, 207
- Brauer graph, 139
- Brauer graph algebra, 140
- Brauer tree, 142
- Brauer tree algebra, 142
- brick, 112
- brick finite algebra, 112

- Cartan matrix, 61, 238
- chain of torsion classes, 328
- character, 334
- characteristic tilting module, 72
- clannish algebra, 169
- classical tilting module, 80, 250
- closed under extensions, 344
- cluster category, 118
- cluster-tilted algebra, 118
- coherent sheaves on a weighted projective line, 95
- cokernel of a morphism, 341
- complement of an almost complete tilting module, 250
- complete projective resolution, 149
- completed path algebra, 120
- composition factors, 234
- composition series, 234, 347
- concealed algebra, 89
- concealed canonical algebra, 96
- connected algebra, 232
- contravariantly finite subcategory, 321
- coproduct of objects in a category, 336
- coresolving subcategory, 320
- costandard modules, 72
- covariantly finite subcategory, 321
- cycle in a module category, 273
- cyclic module, 244

- defect group, 137
- deformation, 309, 310
- degeneration, 309, 310
- degeneration of modules, 294
- degree function, 188
- dense orbit property, 221
- derived category, 355
- derived equivalent algebras, 167

- derived tame algebra, 40
- dg algebra, 192
- differential, 192
- differential graded algebra, 192
- dimension vector of a finite length module, 235
- directed algebra, 30
- directing module, 273
- distinguished triangle, 339
- distributive algebra, 34
- distributive lattice, 34
- dominant dimension, 153, 228
- Dynkin graph, 50
- Dynkin quiver, 56

- enough injectives, 345
- enough projectives, 345
- enveloping algebra, 47, 196
- Euclidean graphs, 50
- Euclidean quiver, 56
- Euler form, 217
- exact category, 343
- exact functor, 344
- exact subcategory, 344
- expansion of a translation quiver, 261

- factor category, 338
- factor object, 347
- fibre product, 341
- fibre sum, 341
- filtered multiplicative basis, 172
- filtration of a module, 234
- finite mutation type, 122
- finite representation typ, 21
- finitely generated module, 224
- finitely presented functor, 350
- finitely presented module, 224
- finitistic dimension, 239
- Finitistic Dimension Conjecture, 240
- fractionally Calabi-Yau algebra, 113
- Frobenius algebra, 130
- Frobenius category, 150, 345
- Frobenius subcategory, 314
- full G -grading, 187
- full exact subcategory, 314, 344
- functorially finite subcategory, 322

- gendo-symmetric algebra, 214
- generalized local algebra, 203
- Generalized Nakayama Conjecture, 242
- generalized standard component, 267
- generic decomposition of an irreducible component, 300
- generic module, 38
- generic number of parameters of an irreducible component, 301
- generically τ -reduced irreducible component, 302
- generically reduced irreducible component, 302
- generically tame algebra, 39
- gentle algebra, 166
- geometrically irreducible algebra, 222
- Ginzburg dg algebra, 194
- global dimension, 227, 244
- Gorenstein projective module, 149
- Gorenstein Symmetry Conjecture, 151
- gradable module, 188
- graded algebra, 187
- graded homomorphism, 188
- graded module, 188
- group algebra, 136

- Harder-Narasimhan filtration, 333
- hereditary algebra, 48
- hereditary category, 98
- Hochschild cohomology algebra, 198
- homogeneous tube, 269
- homotopy category, 353
- homotopy equivalence, 352
- Hopf algebra, 147

- ideal in an additive category, 338
- idempotent complete category, 347
- idempotent completion, 348
- image of a morphism, 347
- indecomposable irreducible component, 299
- indidence algebra, 178
- infinite mutation type, 122
- infinite radical, 263
- initial objects in a category, 336
- injective dimension, 226
- injective object, 345
- injective vertex of a translation quiver, 259
- irreducible homomorphism, 253
- irreducible module, 45
- isomorphic filtrations, 234
- isomorphism of quiver representations, 55
- Iwanaga-Gorenstein algebra, 151

- Jacobian algebra, 121
- Jordan-Hölder multiplicity, 235
- Jordan-Hölder Theorem, 234

- kernel of a morphism, 340
- Koszul algebra, 200
- Koszul dual, 201
- Krull-Remak-Schmidt category, 348
- Krull-Remak-Schmidt Theorem, 203, 236

- Krull-Remak-Schmidt-Azumaya Theorem, 203
- lattice, 33
- layer, 74
- left almost split homomorphism, 254
- left approximation, 321
- left minimal homomorphism, 254, 320
- length category, 347
- length of a filtration, 234
- length of a module, 234
- length of an object, 347
- local ring, 235
- locally finite quiver, 258
- locally hereditary algebra, 186
- loop, 259

- maximal Cohen-Macaulay modules, 152
- maximal green sequence, 330
- mesh category, 260
- minimal approximation, 321
- minimal representation-infinite, 90
- monomial algebra, 174
- morphism of representations of a poset, 176
- multiplicative basis, 172
- multiplicative Cartan basis, 173

- Nagase P -minimal algebra, 205
- Nakayama algebra, 157
- Nakayama Conjecture, 242
- Nakayama functor, 257
- Nakayama functors, 108
- noetherian category, 347
- non-degenerate potential, 123
- non-negative quadratic form, 217
- non-standard algebra, 28

- octahedral axiom, 339
- one-point extension algebra, 206
- oriented cycle in quiver, 53

- partial tilting module, 250, 324
- path (in a module category), 273
- path algebra, 53
- path in a module category, 29
- path in a quiver, 53
- periodic algebra, 143
- phase, 332, 334
- pointed category, 336
- potential, 121, 193
- preabelian category, 346
- preadditive category, 337
- preinjective component, 268
- preinjective module, 268
- preprojective algebra, 65
- preprojective component, 89, 268
- preprojective module, 89, 268
- presentation of a functor, 350
- principal block, 138
- prinjective modules over an incidence algebra, 180
- prinjective tame poset, 184
- prinjective wild poset, 184
- product of objects in a category, 336
- projective dimension, 226
- projective object, 345
- projective vertex of a translation quiver, 259
- pullback, 341
- pushout, 341

- quadratic algebra, 199
- quasi-canonical algebra, 96
- quasi-hereditary algebra, 69
- quasi-isomorphism, 353
- quasi-tilted algebra, 99
- quiver, 52
- quiver with potential, 121

- reachable module, 274
- refinement of a filtration, 234
- reflexive module, 149
- regular component, 268
- repetitive algebra, 133
- representable functor, 349
- representation dimension, 229
- representation of a group, 136
- representation of a poset, 176
- representation of a quiver, 54
- representation-finite algebra, 21
- representation-finite poset, 176
- representation-infinite algebra, 21
- resolving subcategory, 320
- Richmond stratum, 306
- Riedtmann sequence, 294
- right almost split homomorphism, 255
- right approximation, 321
- right minimal homomorphism, 255, 320
- rigid module, 248
- Ringel dual of a quasi-hereditary algebra, 72

- Schreier's Theorem, 234
- Schur algebra, 76
- sectional path, 268
- see-saw property, 332
- selfinjective algebra, 128
- selforthogonal module, 248
- semi Gorenstein projective module, 149
- semiperfect ring, 348
- semiregular component, 268
- semiregular tube, 268
- semisimple algebra, 46

- semisimple module, 45
- separable algebra, 47, 144
- separating family of components, 92
- Serre subcategory, 319
- shod algebra, 100
- short exact sequence, 344
- short exact sequence in an abelian category, 346
- simple module, 45
- simply laced Dynkin graphs, 50
- sincere component, 91
- sincere family of components, 91
- sincere module, 31, 91, 273
- singularity category, 153
- sink map, 255
- skewed-gentle algebra, 170
- slicing of a length category, 329
- socle projective module, 180
- source map, 254
- special biserial algebra, 163
- species algebra, 64
- split epimorphism, 253
- split monomorphism, 253
- split valuation for a translation quiver, 261
- splitting field, 30, 288
- stability function, 332, 333
- stable category, 257, 345
- stable component, 270
- stable translation quiver, 259
- stable tube, 269
- standard component, 267
- standard module, 68
- standardly stratified algebra, 69
- string algebra, 164
- strongly quasi-hereditary algebra, 72
- subobject, 346
- subset, 177
- subrepresentation of a quiver representation, 55
- superdecomposable module, 47
- symmetric algebra, 131
- symmetrizable generalized Cartan matrix, 49, 61
- tame n -domestic algebra, 37
- tame algebra, 36
- tame domestic algebra, 37
- tame exponential growth algebra, 37
- tame linear growth algebra, 37
- tame polynomial growth algebra, 37
- tame poset, 184
- tensor algebra, 196
- terminal objects in a category, 336
- thick subcategory, 319
- tilted algebra, 84
- tilting bundle, 96
- tilting complex, 84
- tilting module, 80, 250
- tilting modules, 324
- tilting object in a hereditary category, 98
- tilting sheaf, 96
- tilting triple, 80
- Tits form, 49, 185, 216
- Tits form of a poset, 177
- torsion class, 80, 322
- torsion pair, 80, 322
- torsion-free class, 80, 322
- torsion-free group, 189
- torsionless module, 149
- torsionless-finite algebra, 307
- translation quiver, 259
- tree algebra, 217
- triangle, 338
- triangle equivalence, 340
- triangle functor, 340
- triangulated category, 339
- trivial extension algebra, 132
- tubular algebra, 102
- twisted fractionally Calabi-Yau algebra, 113
- twisted periodic, 144
- uniserial length category, 347
- uniserial module, 157
- valuation of a translation quiver, 261
- valued translation quiver, 261
- variety of d -dimensional modules, 293
- vector space category, 208
- virtual degeneration, 295
- weakly n -representation-finite algebra, 109
- weakly Gorenstein algebra, 150
- weakly non-negative quadratic form, 177, 217
- weakly positiv quadratic form, 217
- weakly positive quadratic form, 177
- weakly shod algebra, 101
- weakly symmetric algebra, 130
- weighted projective line, 94
- wide subcategory, 317
- wild poset, 184
- Yoneda algebra, 197, 201
- zero object in a category, 336

JAN SCHRÖER
MATHEMATISCHES INSTITUT
UNIVERSITÄT BONN
ENDENICHER ALLEE 60
53115 BONN
GERMANY

E-mail address: `schroer@math.uni-bonn.de`